

SUPPORTING INFORMATION FOR

Synthetic Versatility of 2-Substituted-6-methyl 2,3-dihydropyridinones accessed via the Vinylogous Mannich Reaction in the Construction of Chiral Polyfunctional Piperidine-based Compounds and β Amino Acid Derivatives

Yang Yang*, Clayton Hardman

Genomics Institute of the Novartis Research Foundation

10675 John Jay Hopkins Drive, San Diego, California 92121

yyang@gnf.org

TABLE OF CONTENTS:

NMR spectra copy of compounds **10a-i; 12; 13; 14b-e; 15a-e; 16a-e; 17; 18; 19; 20; 21; 22a-d; 23a-b; 24a-b; 25a-g; 26a-g; 27; 28.**

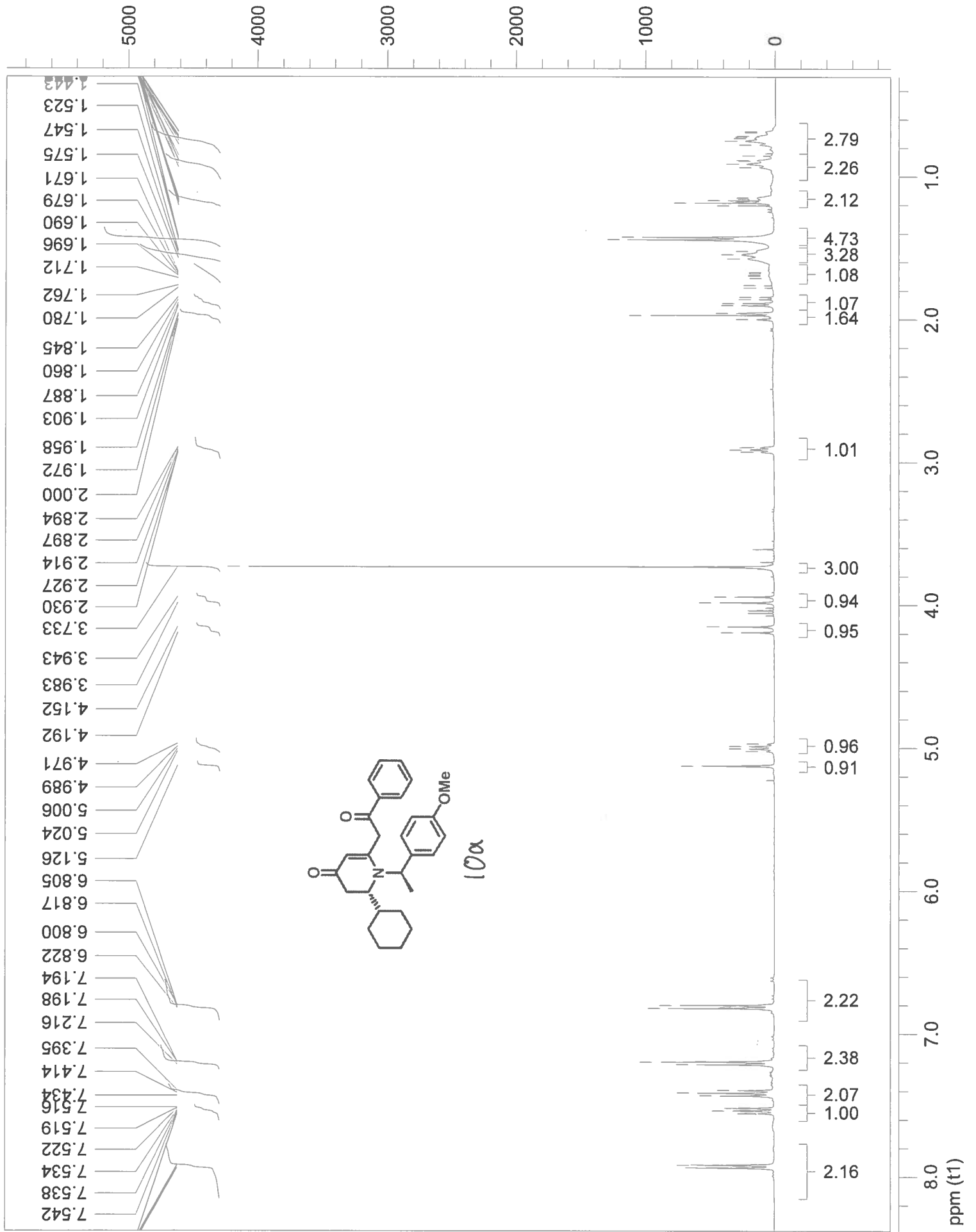

1D — None —

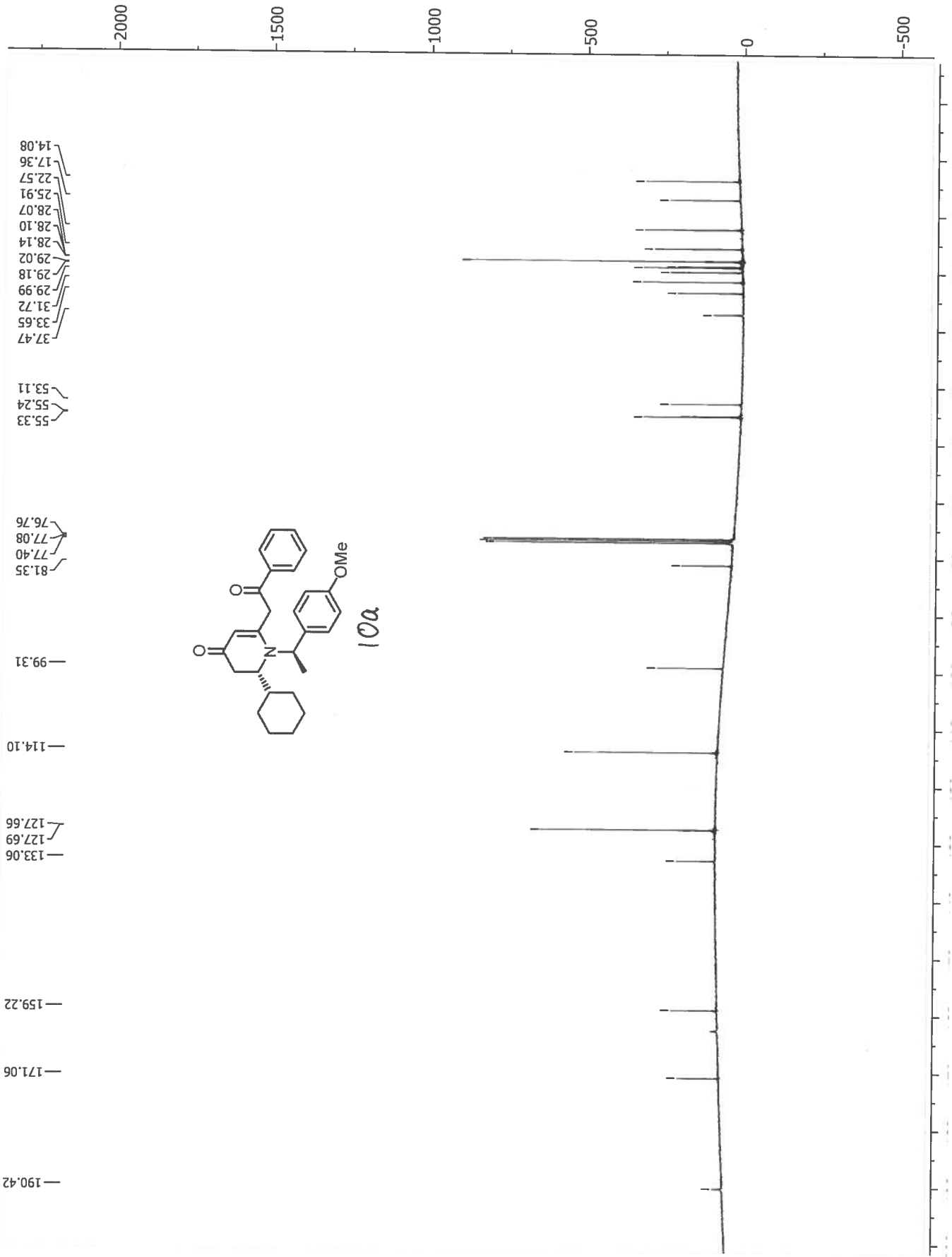

1D — yy-10-vc-74.1.fid —

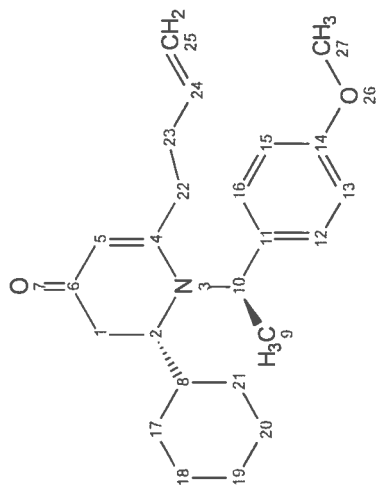

10b

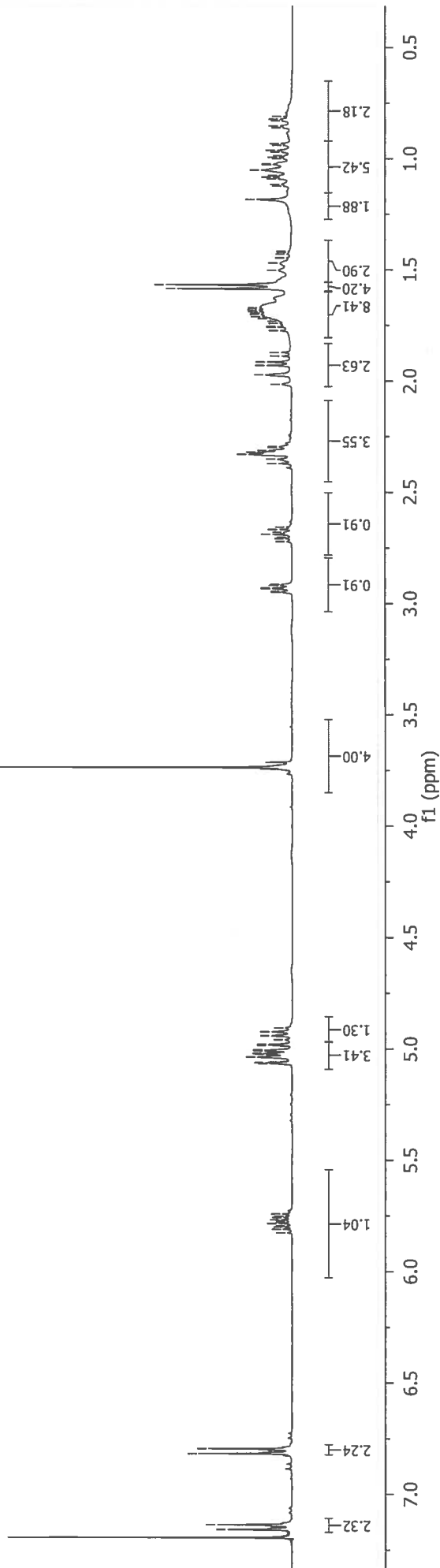

yy-10-vc-74.2.fid

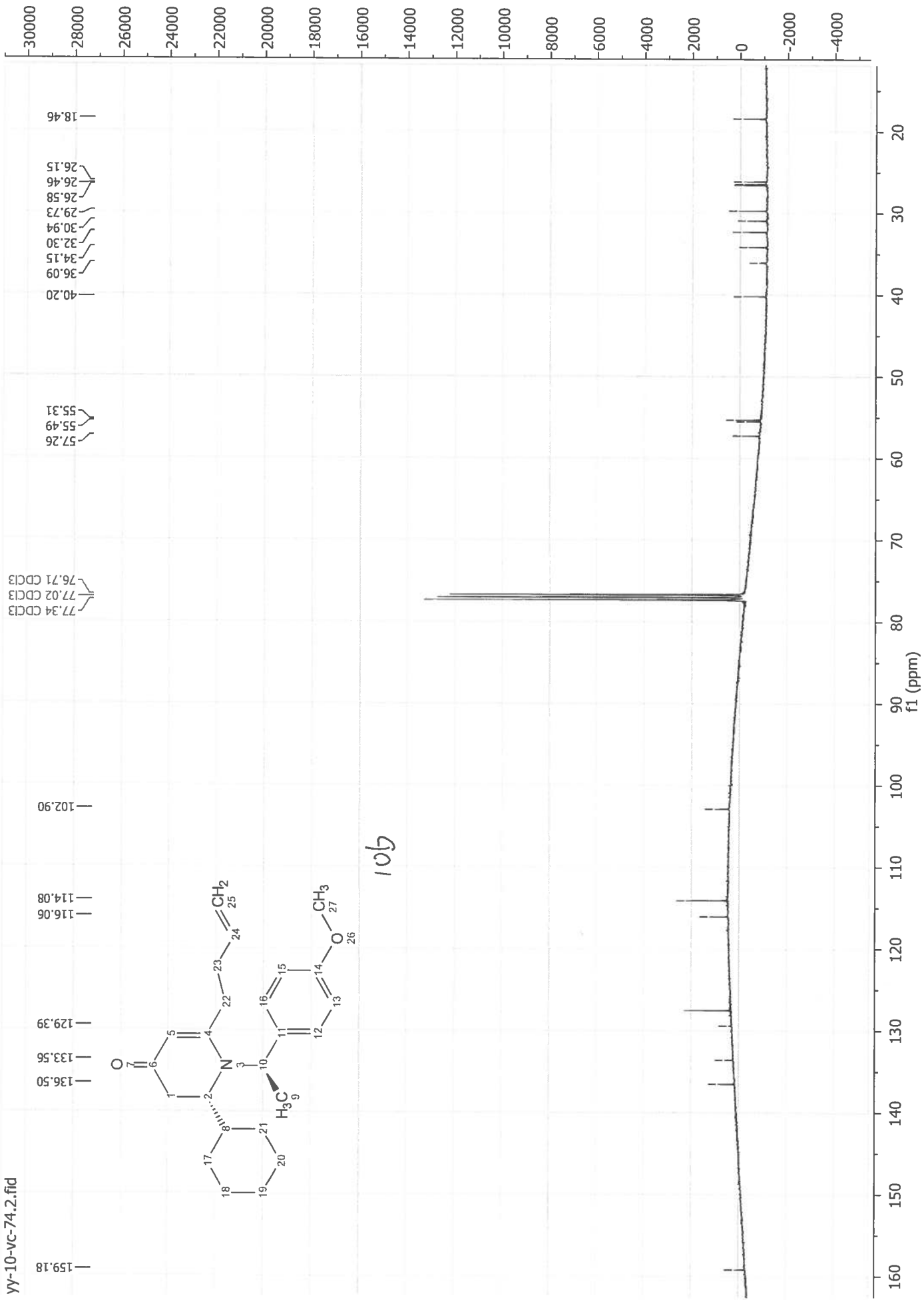

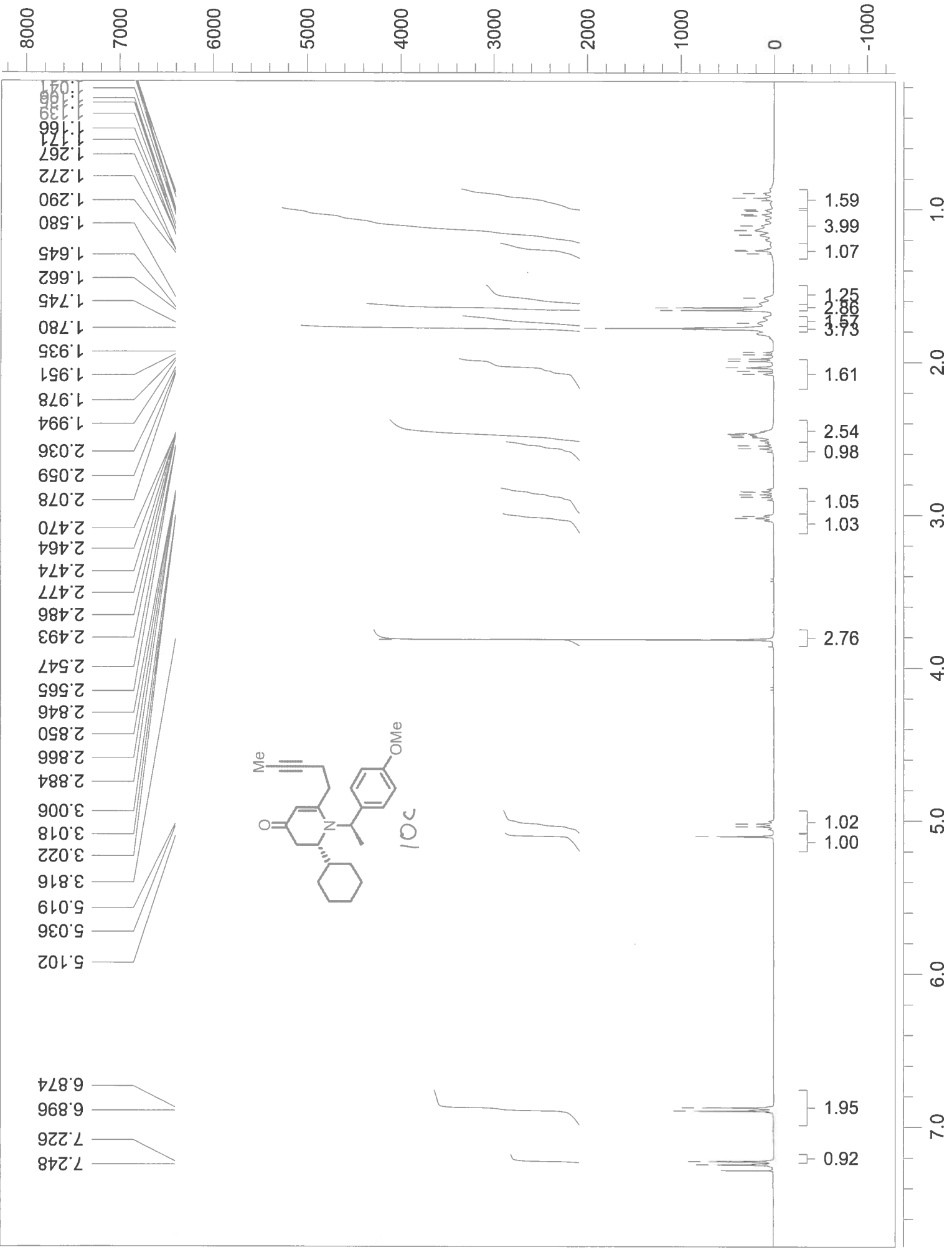

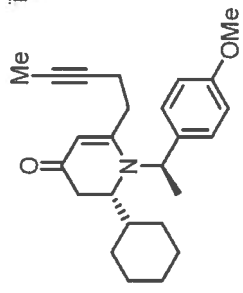

100

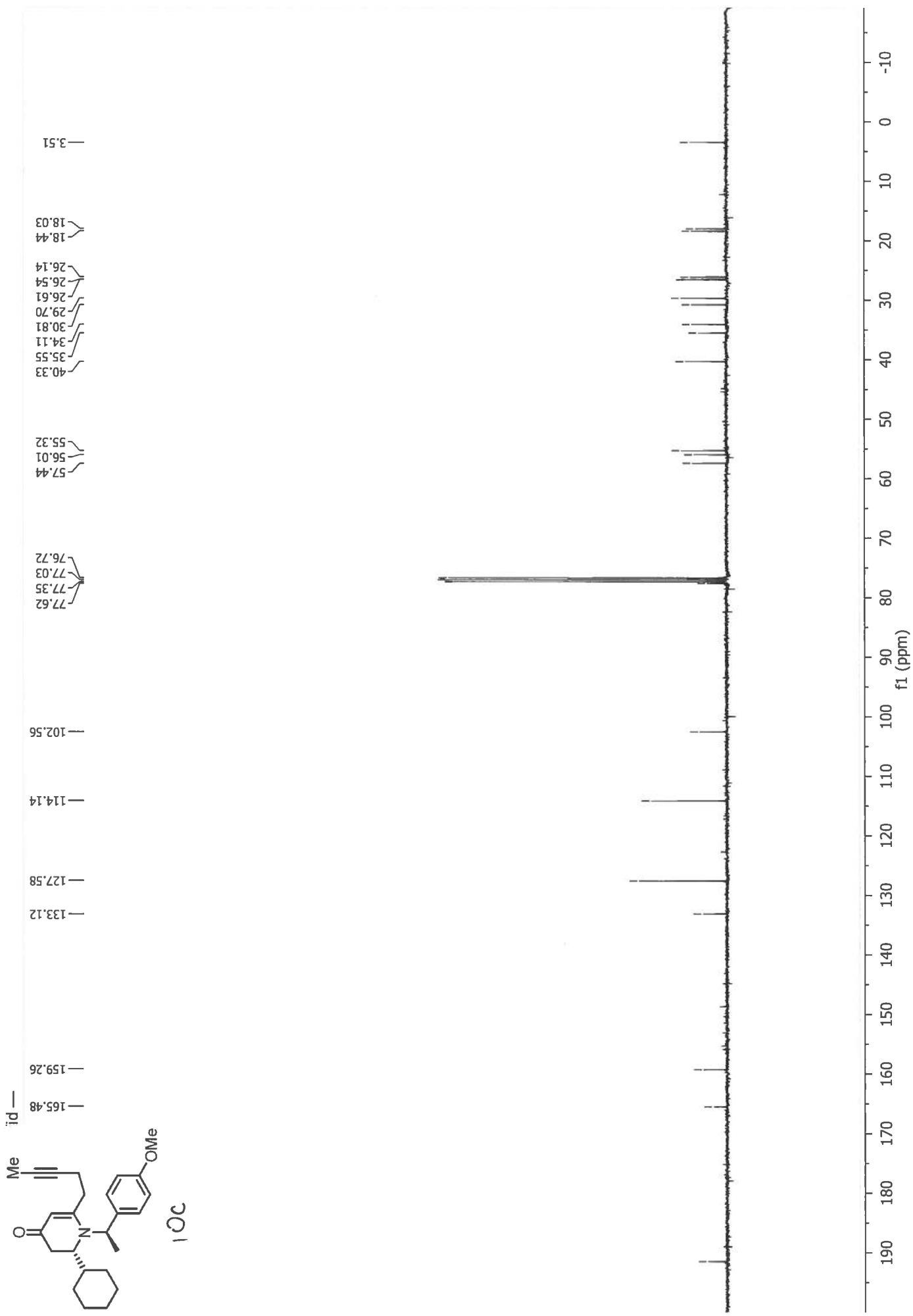

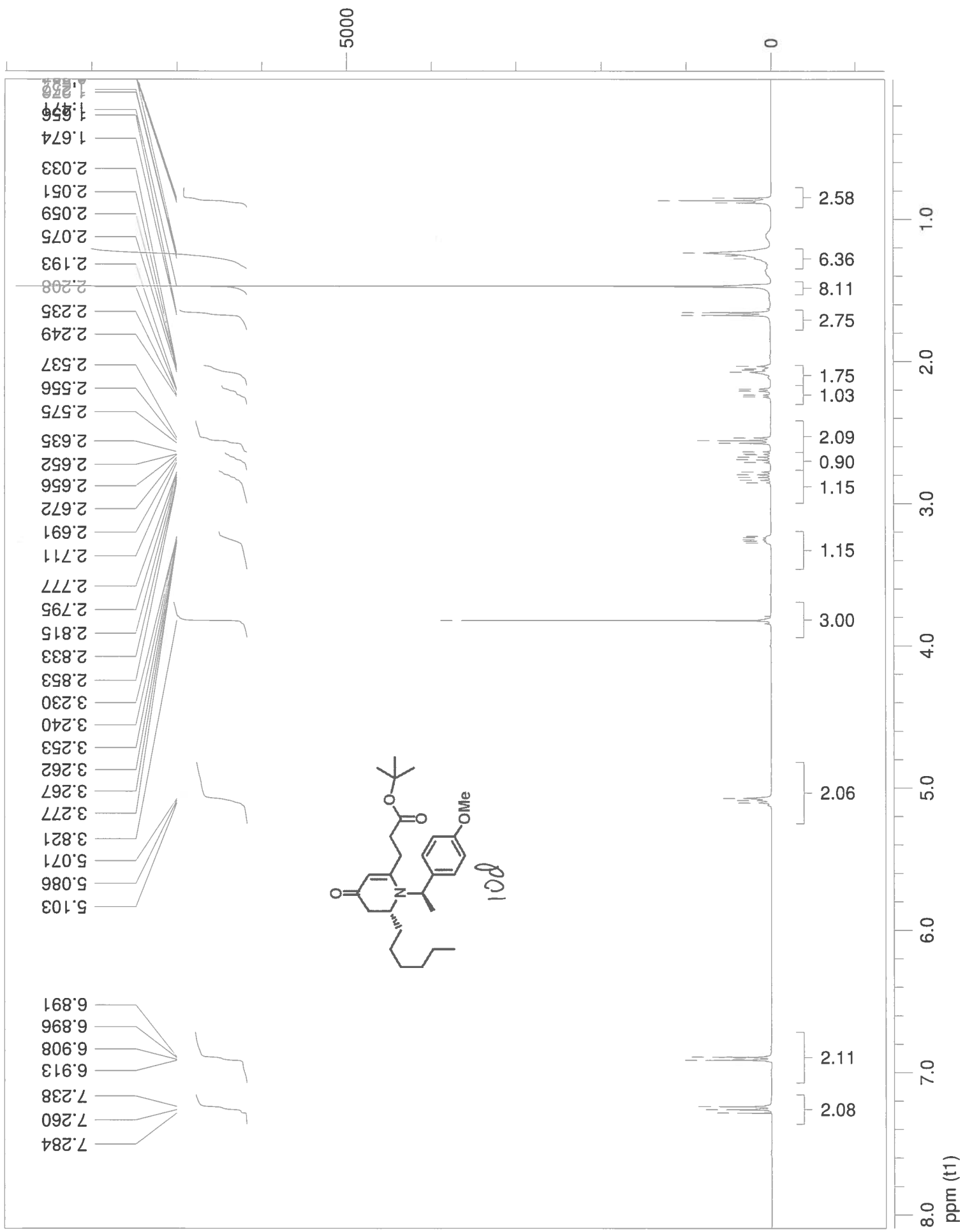

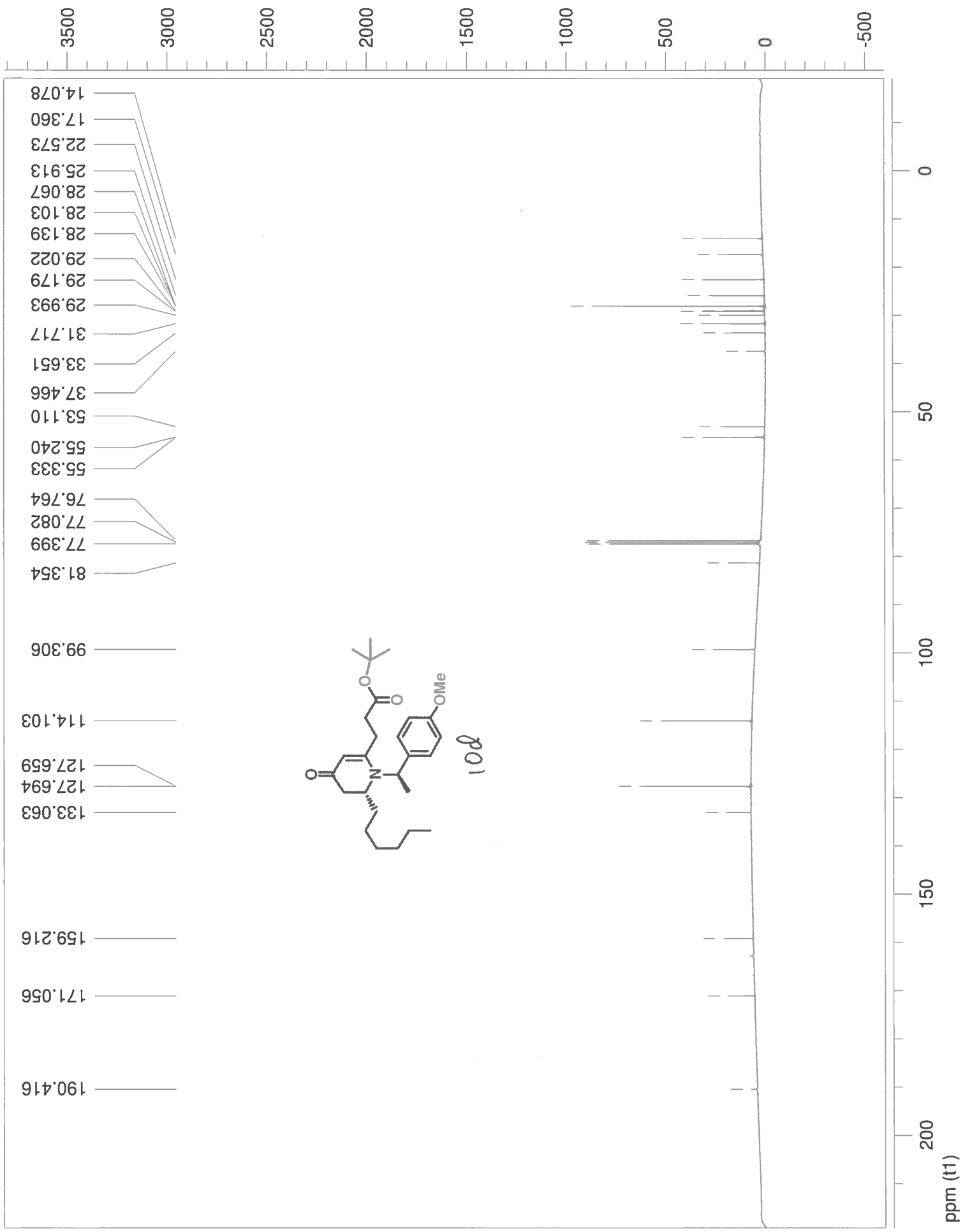

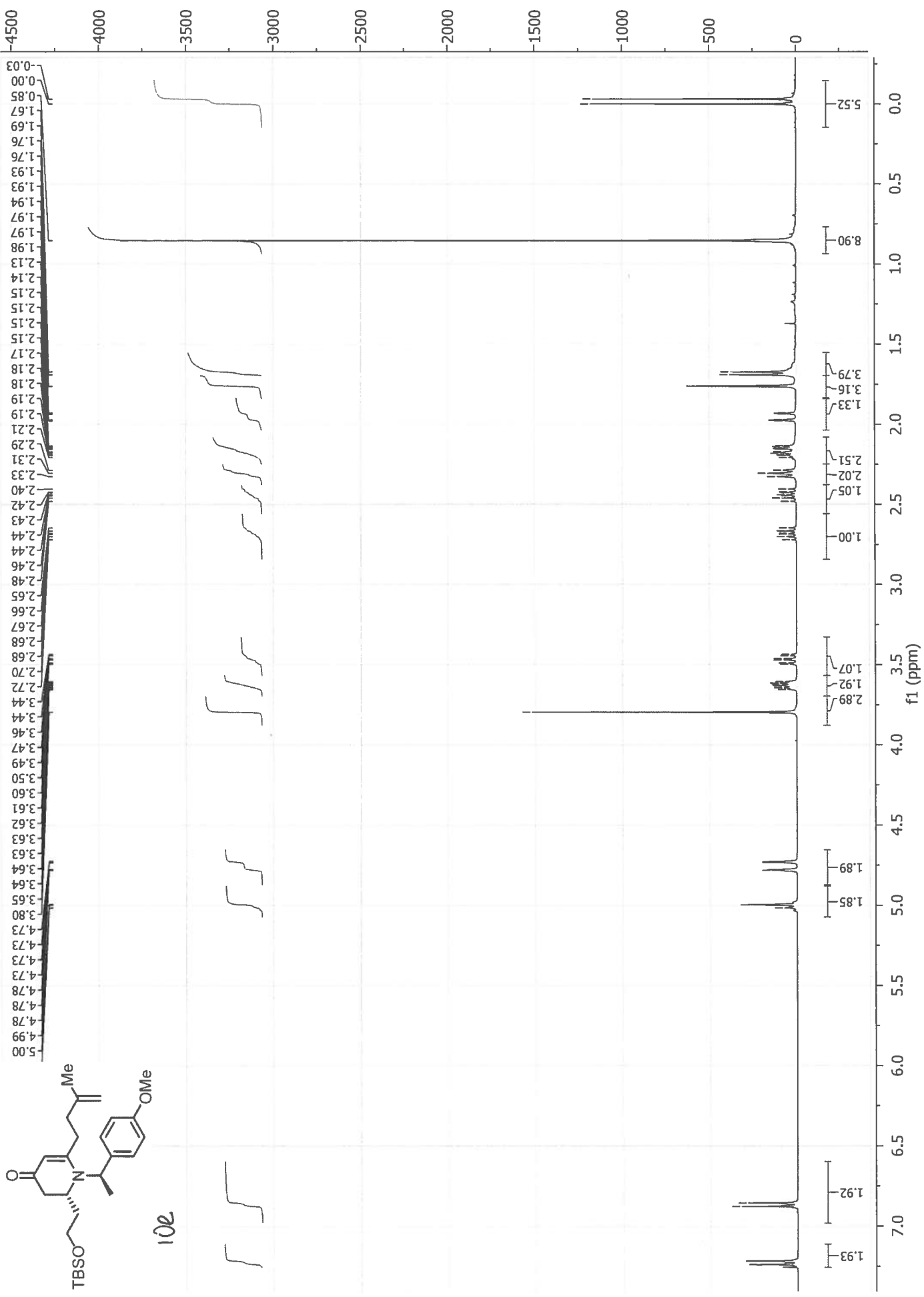

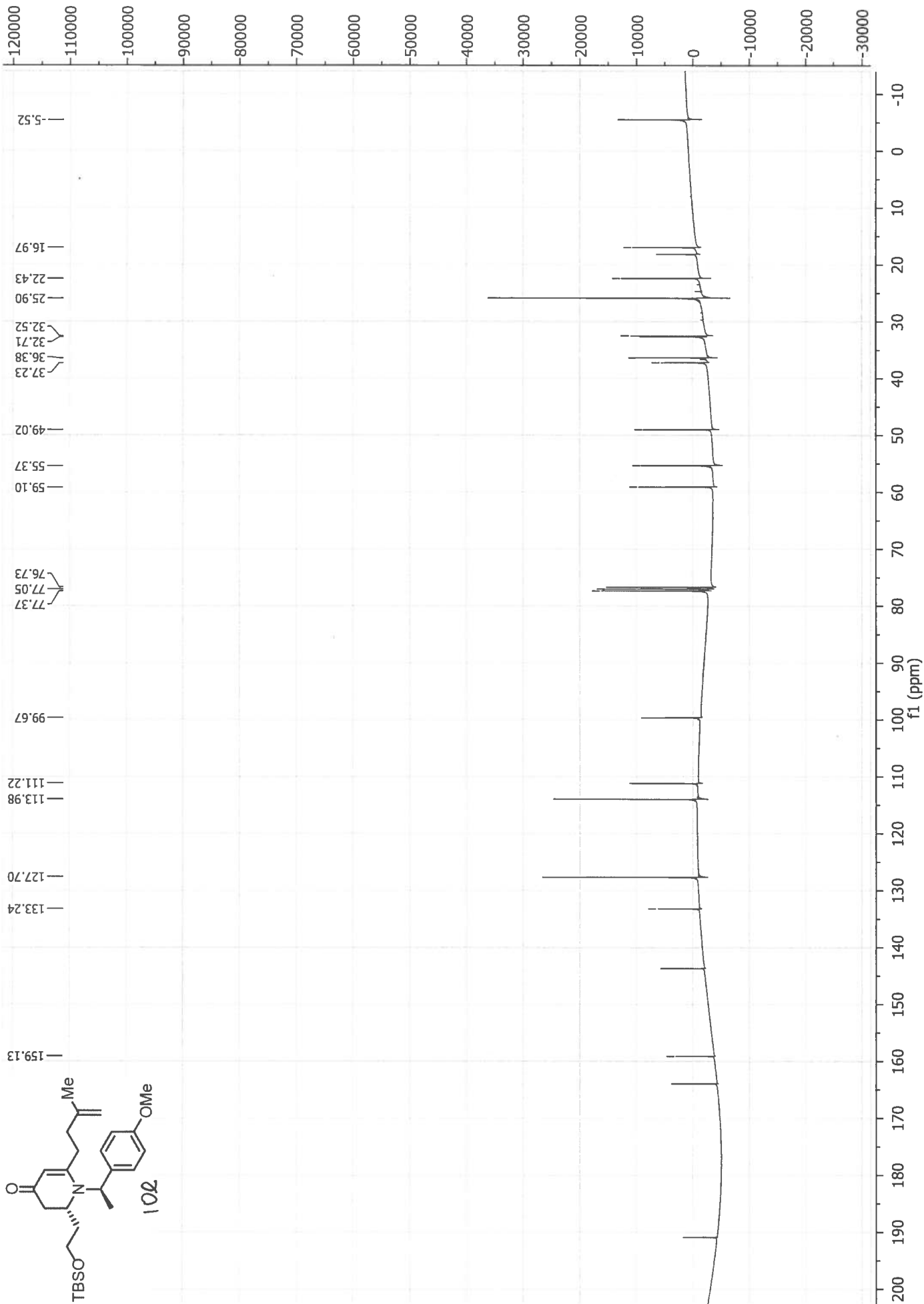

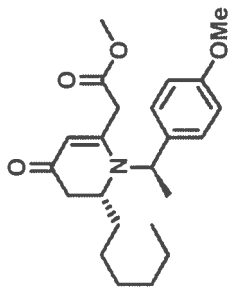

Chemical Formula: $C_{23}H_{33}NO_4$

Exact Mass: 387.24096

Molecular Weight: 387.52000

10f

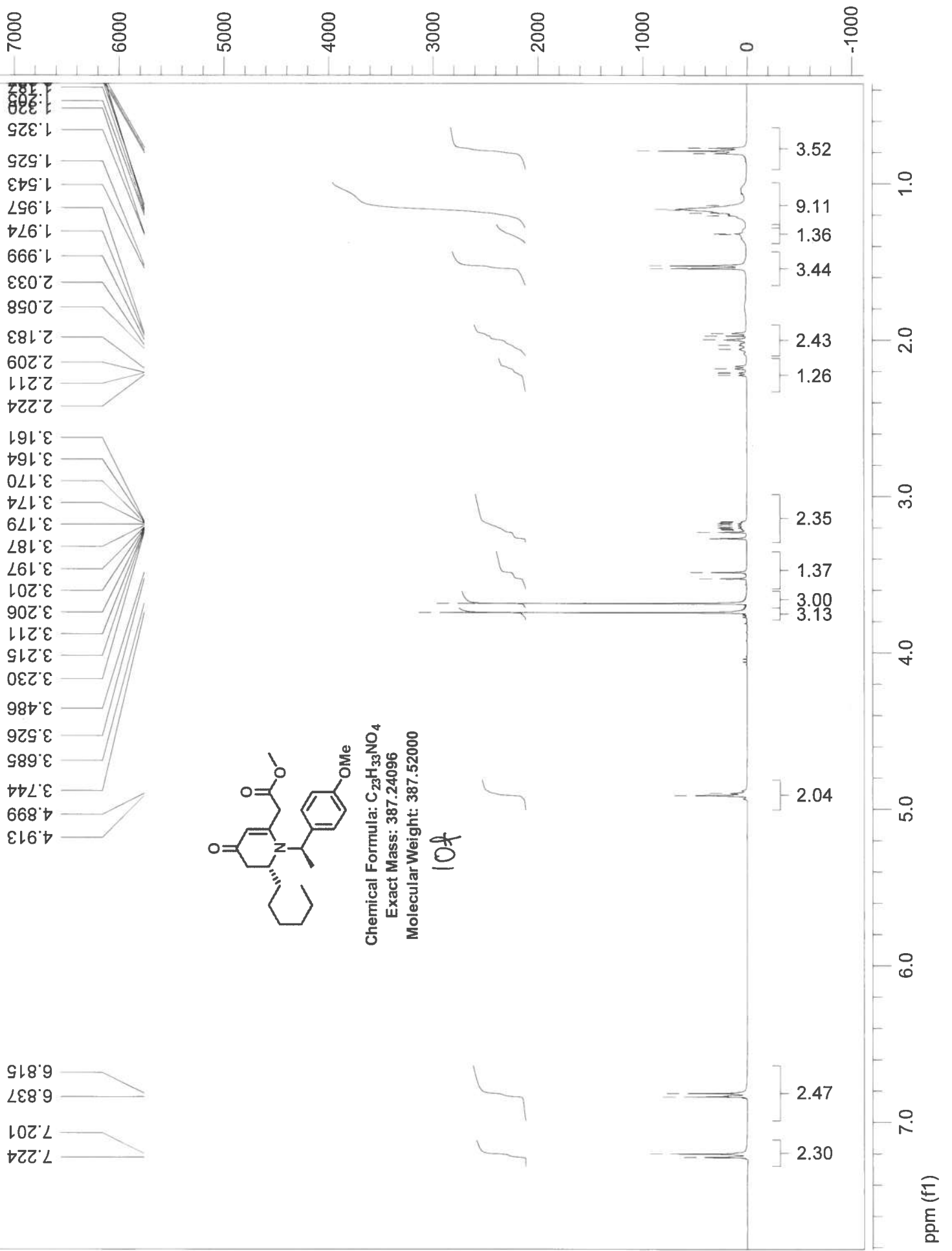

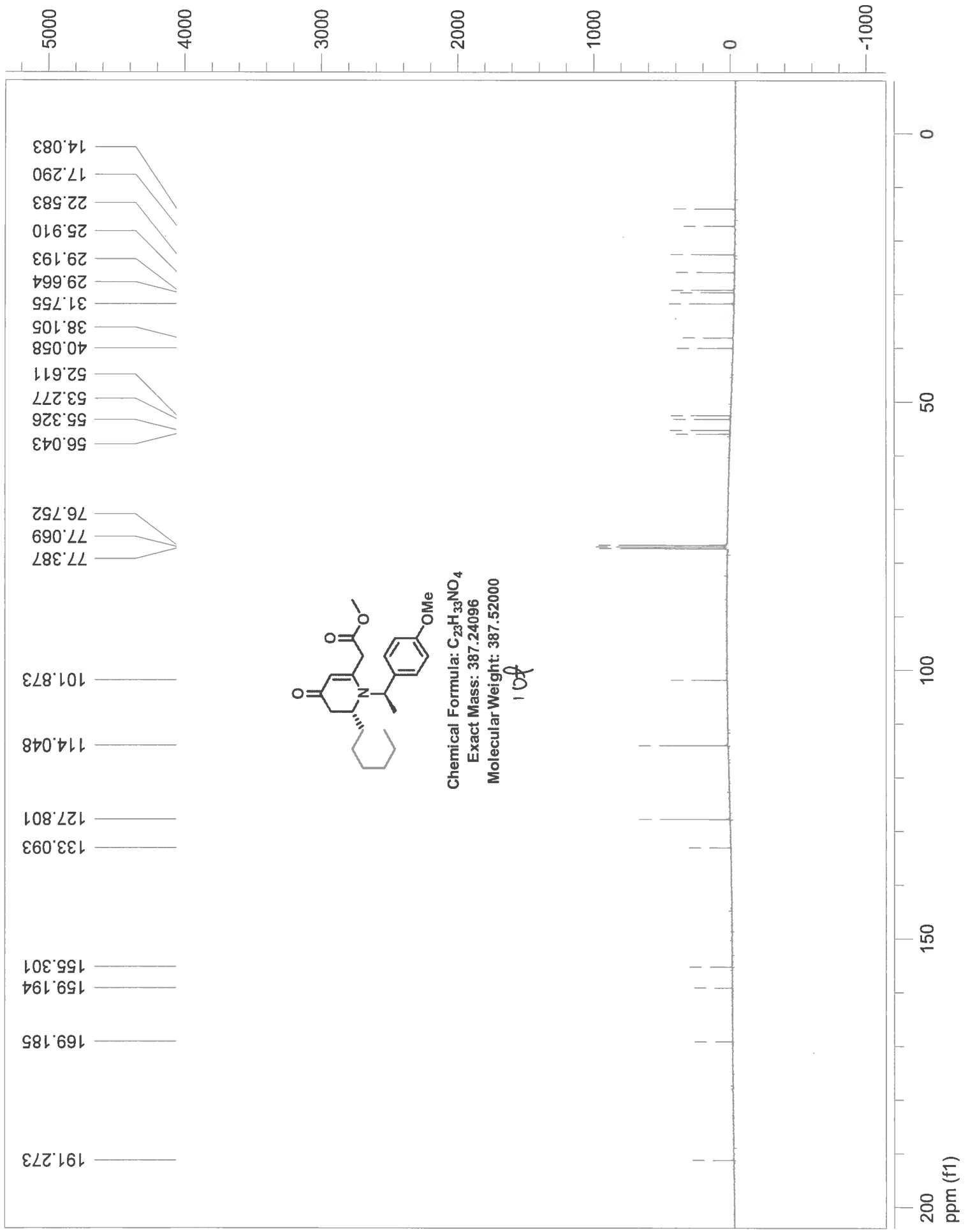

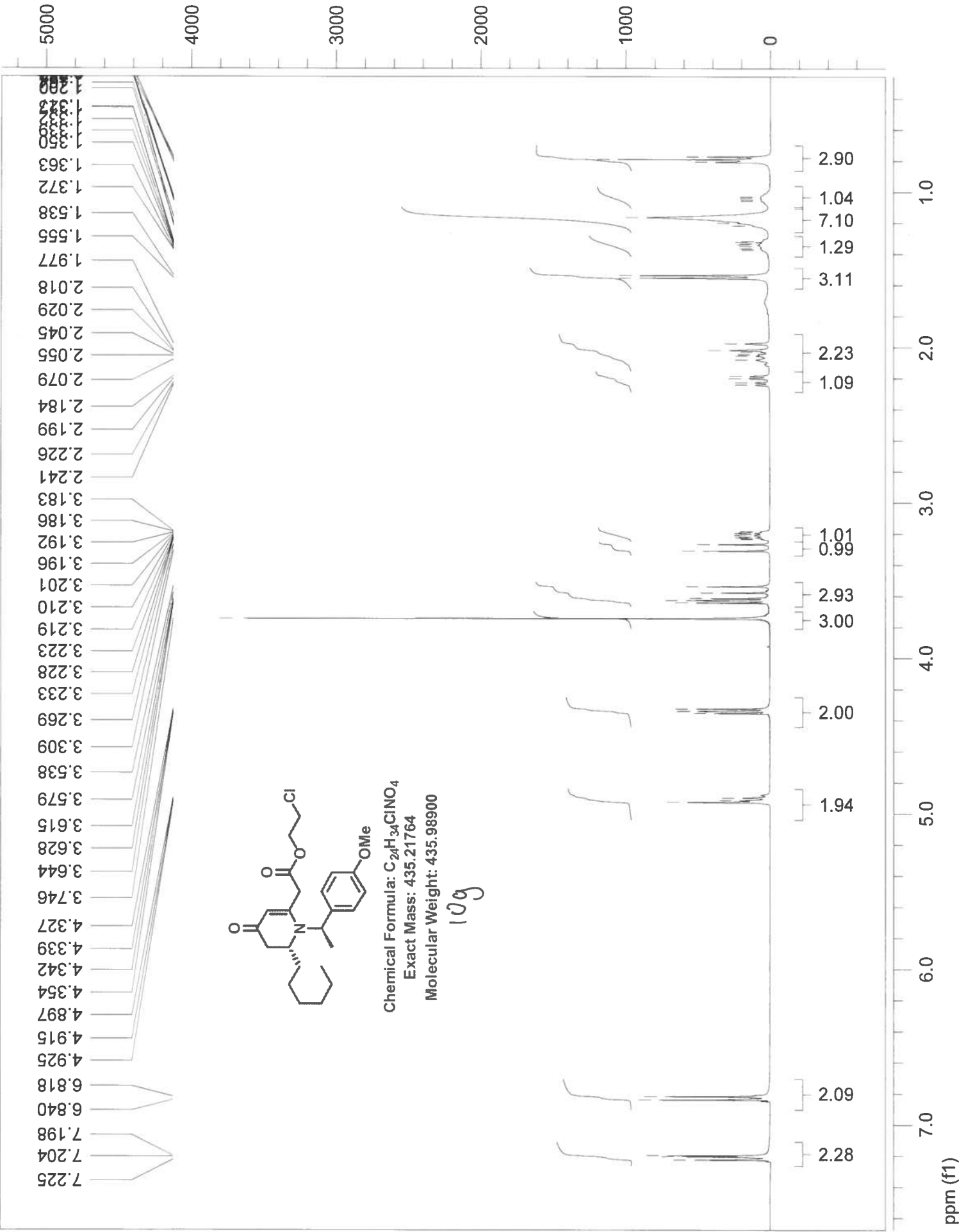

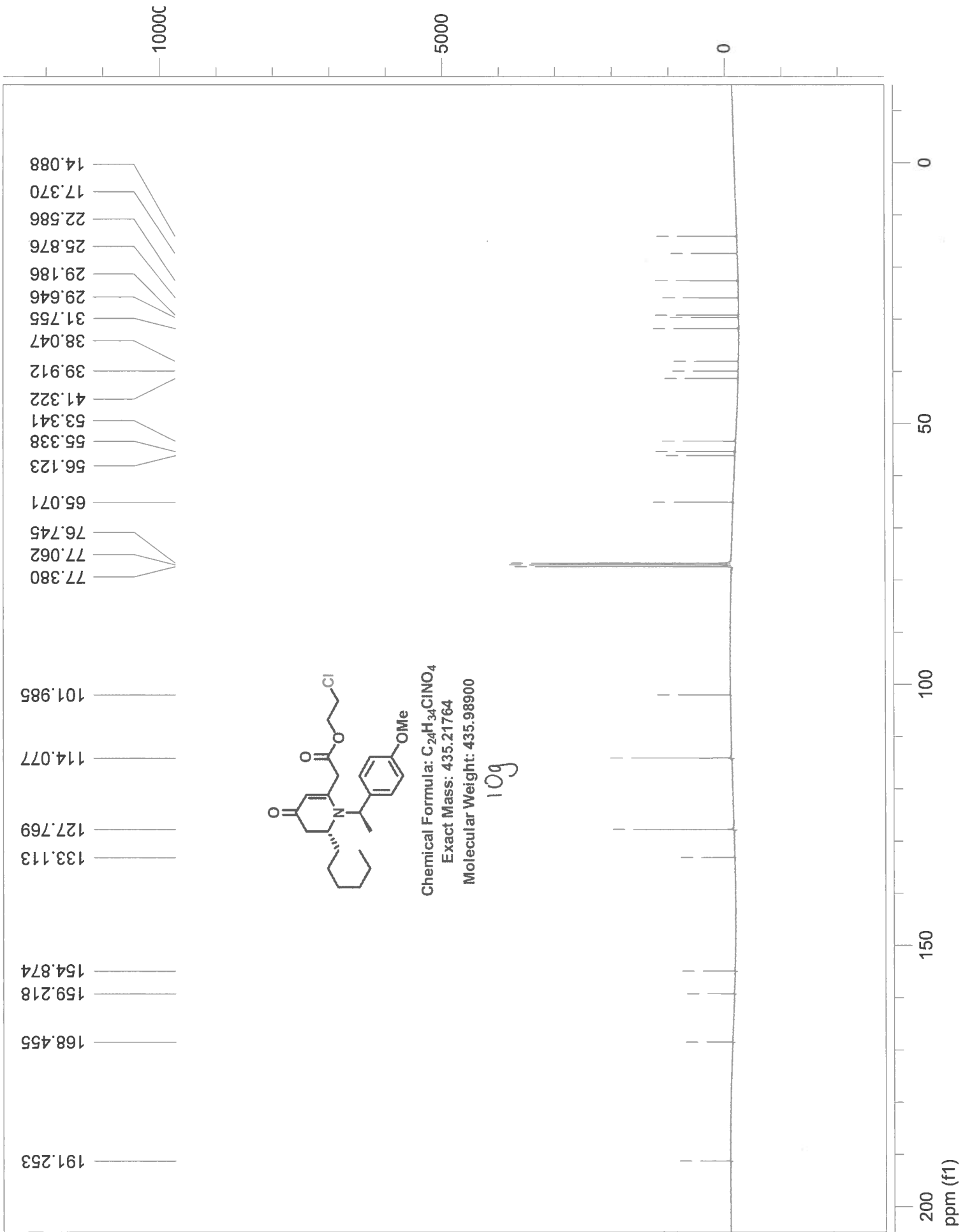



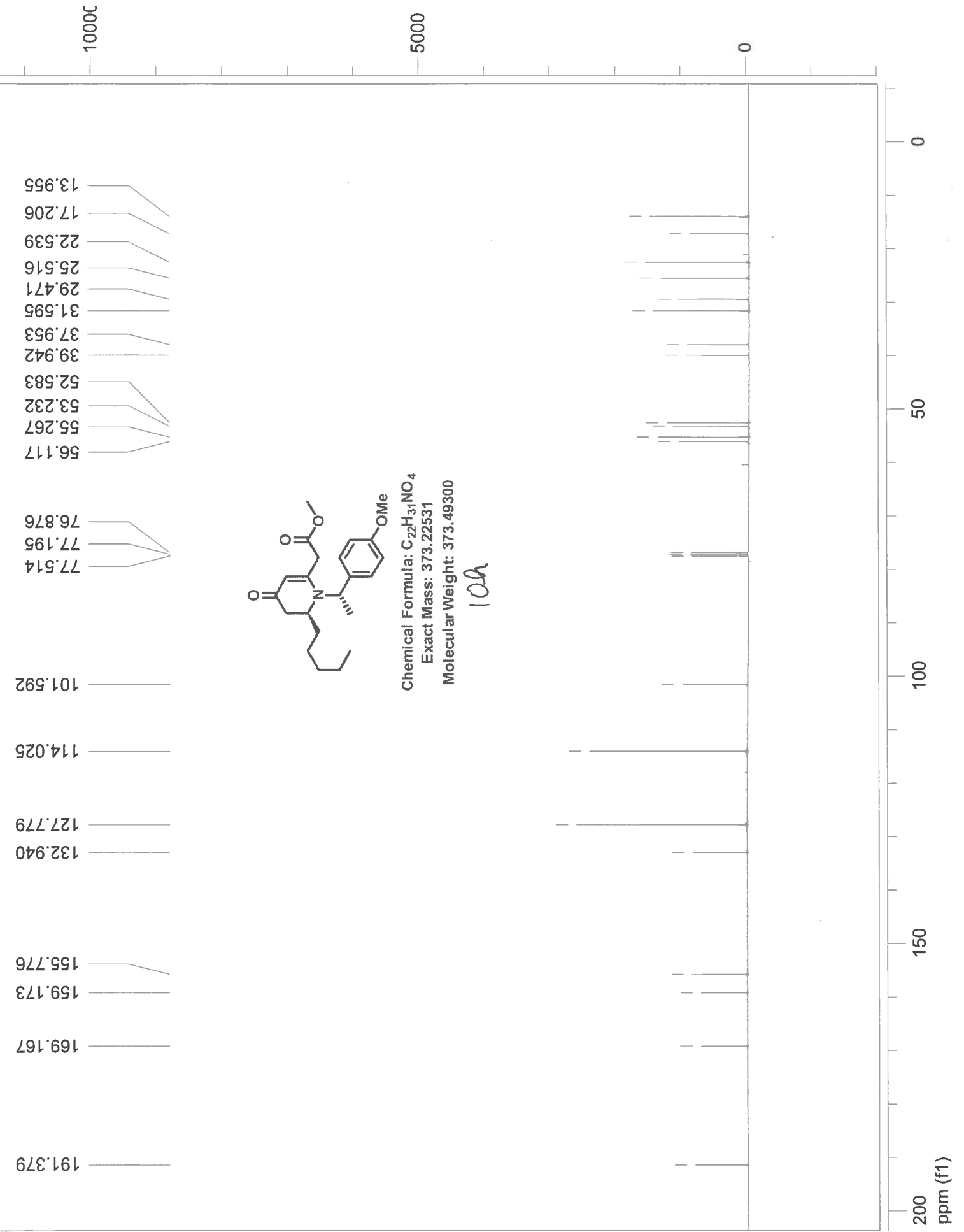

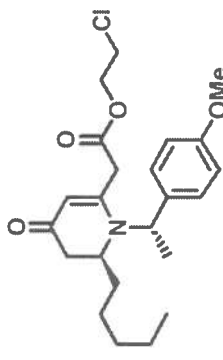

Chemical Formula: $C_{23}H_{32}ClNO_4$
 Exact Mass: 421.20199
 Molecular Weight: 421.96200

10i

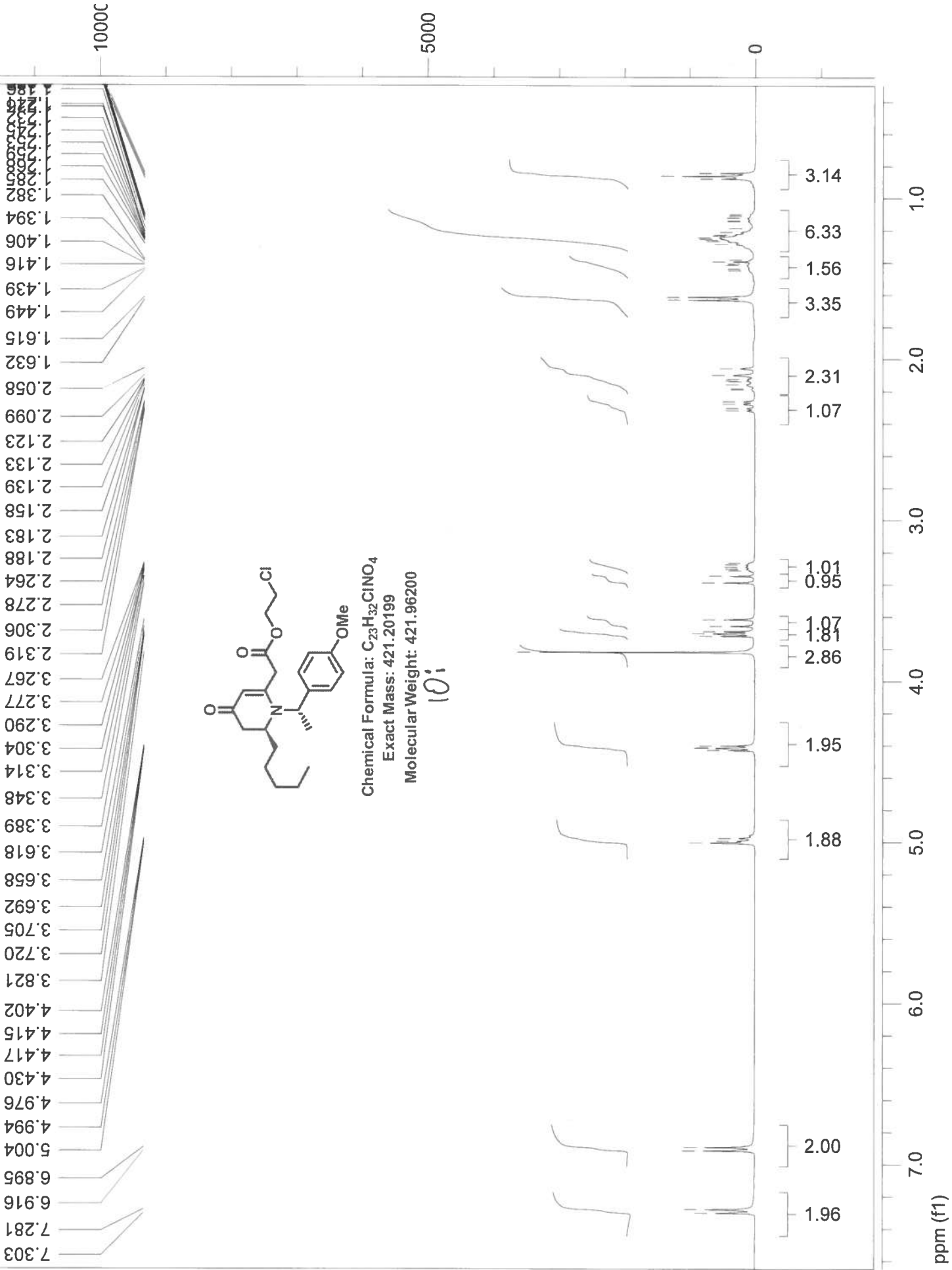

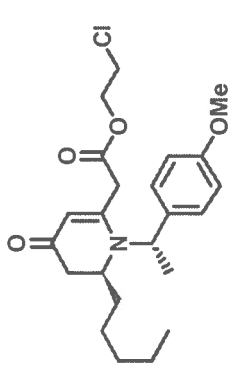
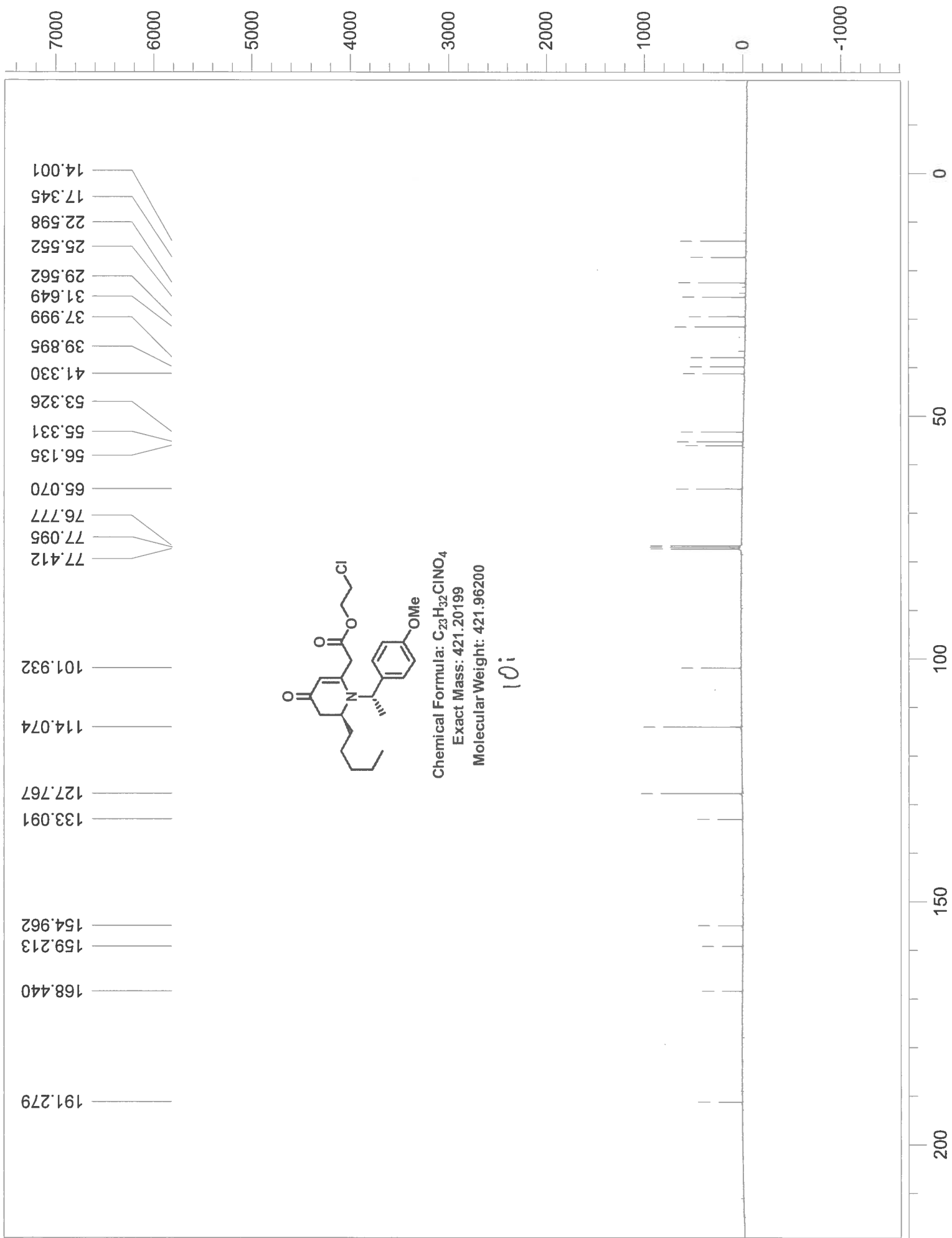

Chemical Formula: C₂₃H₃₂ClNO₄
 Exact Mass: 421.20199
 Molecular Weight: 421.96200

10i

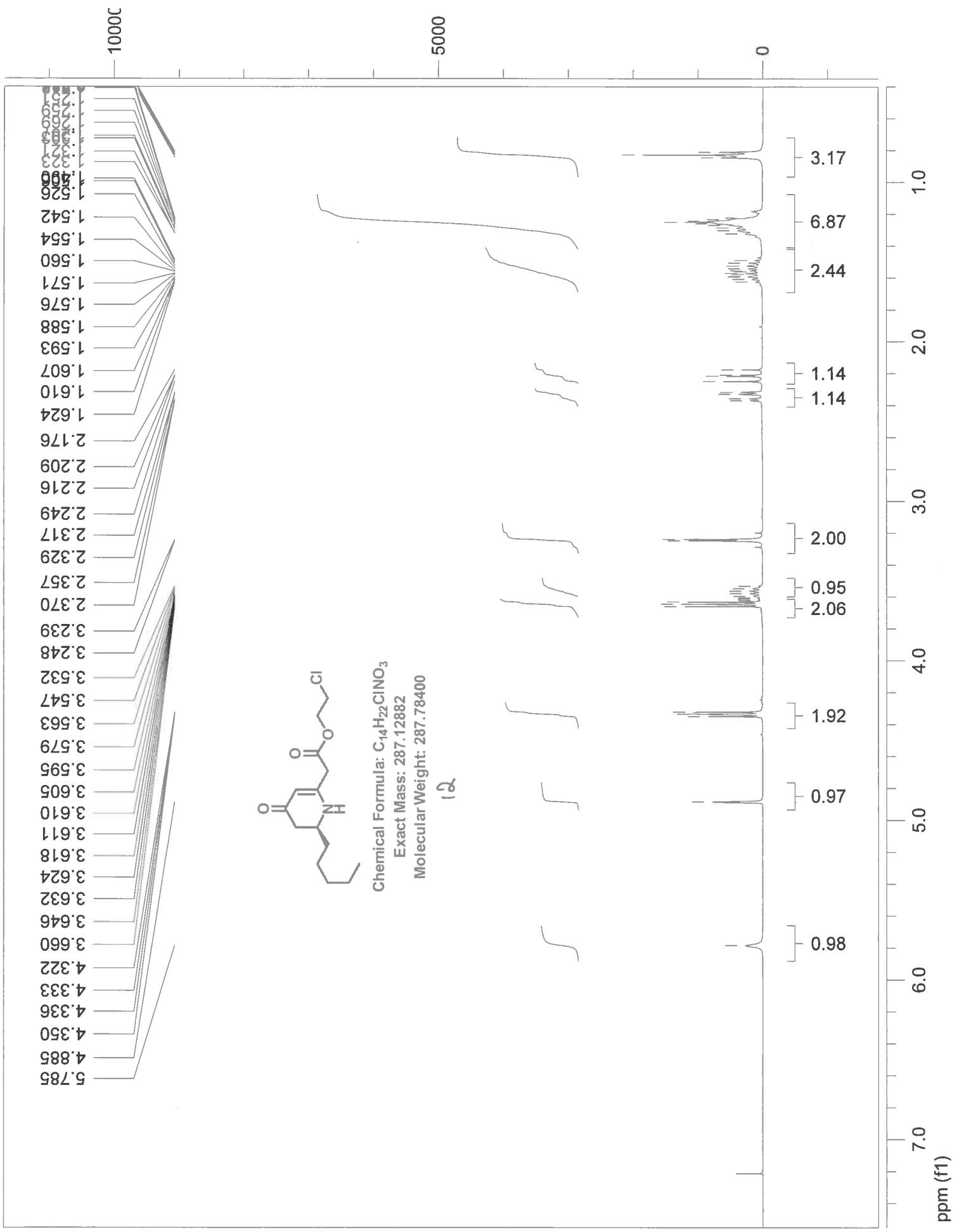

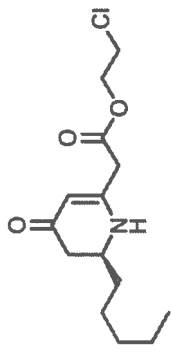

Chemical Formula: $C_{14}H_{22}ClNO_3$

Exact Mass: 287.12882

Molecular Weight: 287.78400

12

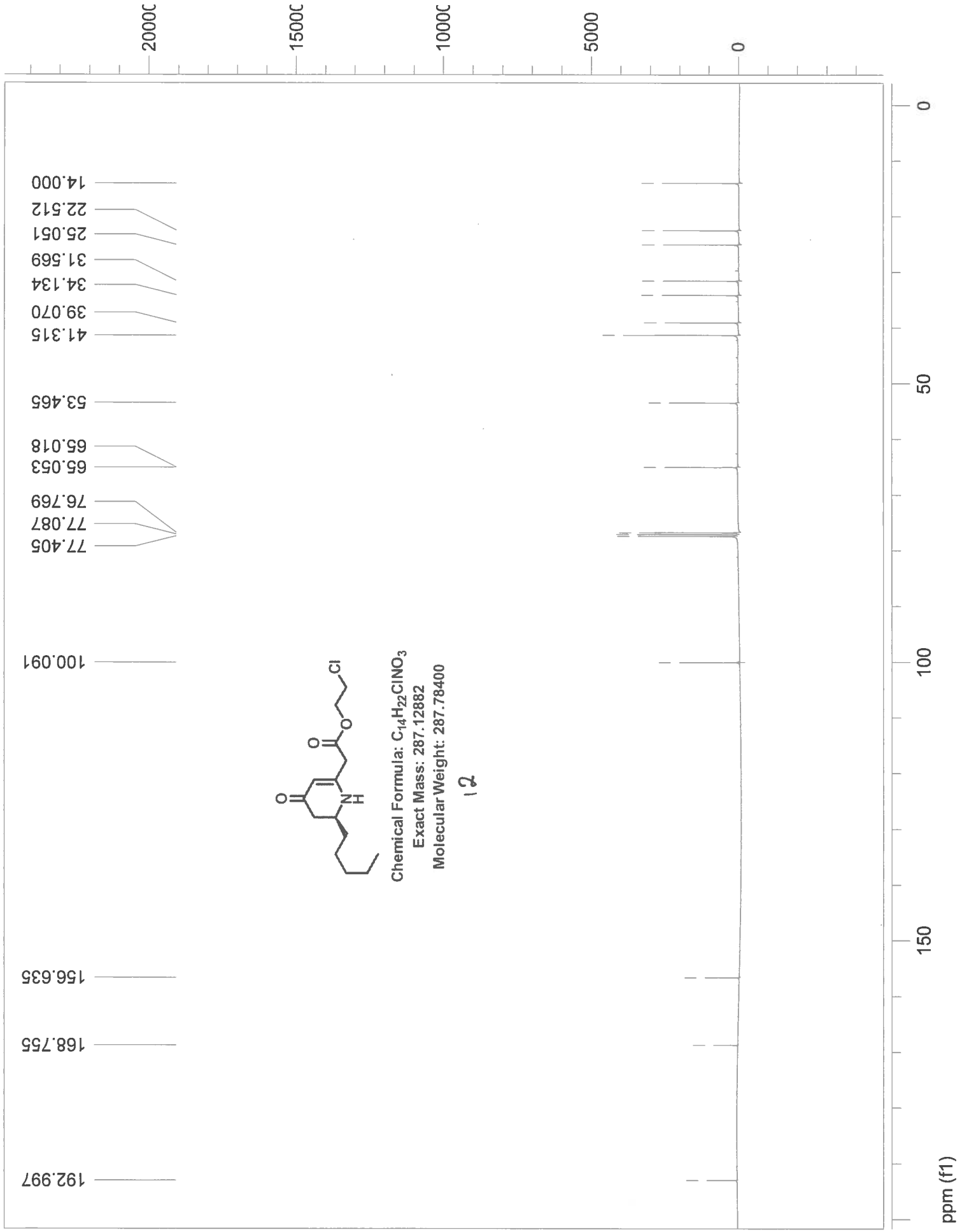

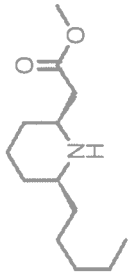

Chemical Formula: C₁₃H₂₅NO₂
 Exact Mass: 227.18853
 Molecular Weight: 227.34800

13

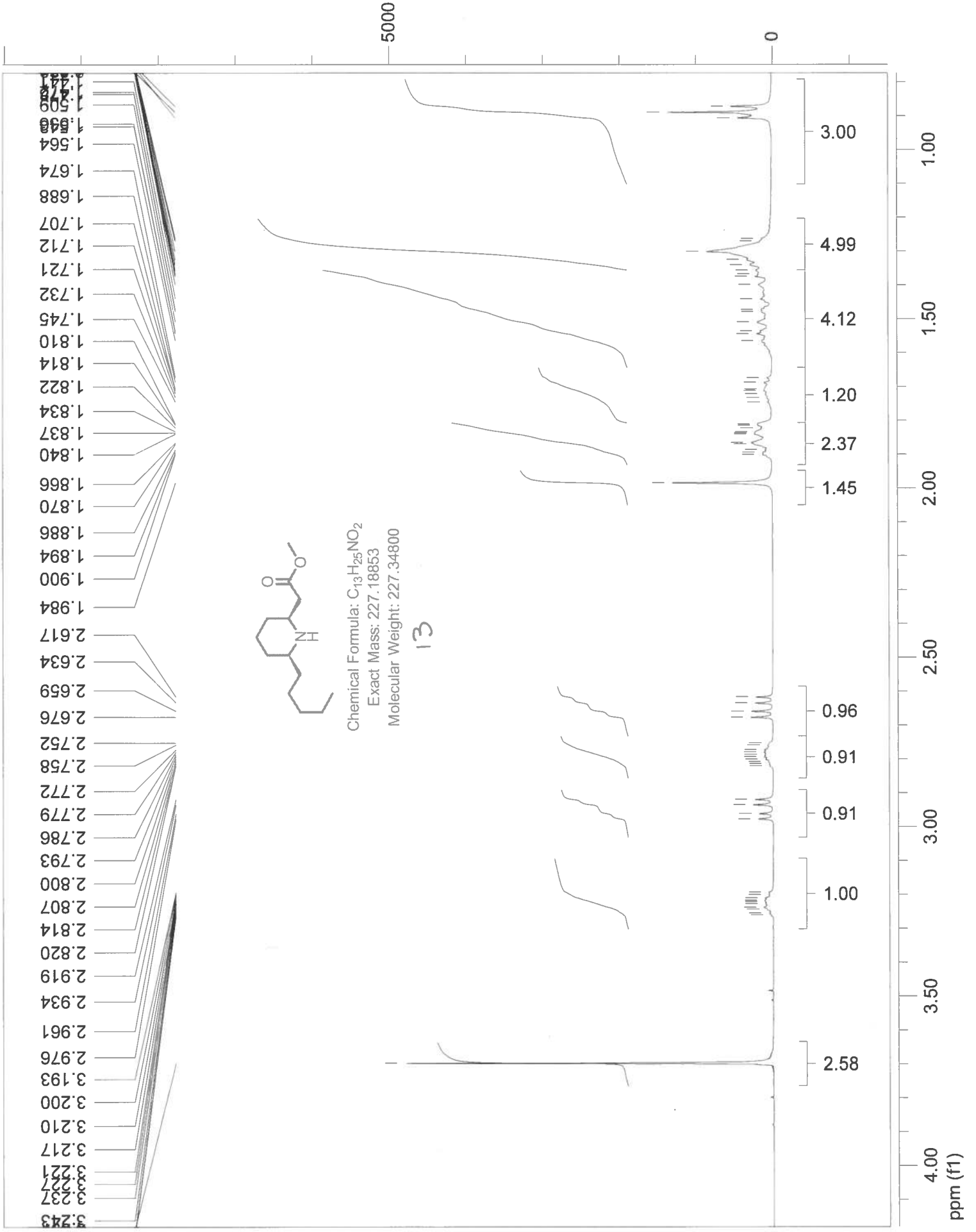

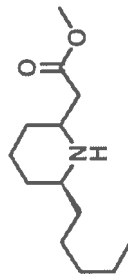

Chemical Formula: C₁₃H₂₅NO₂
Exact Mass: 227.18853
Molecular Weight: 227.34800

13

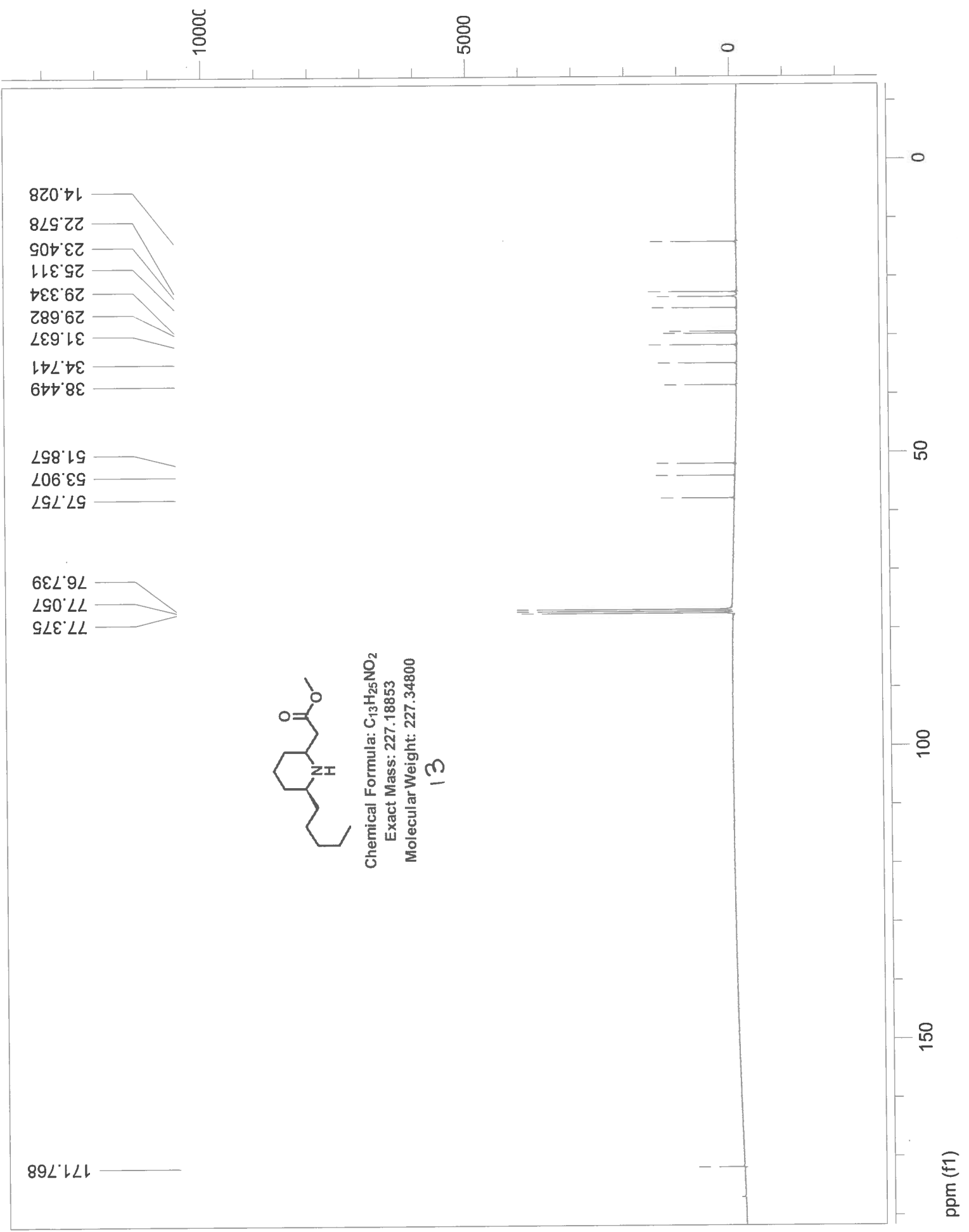

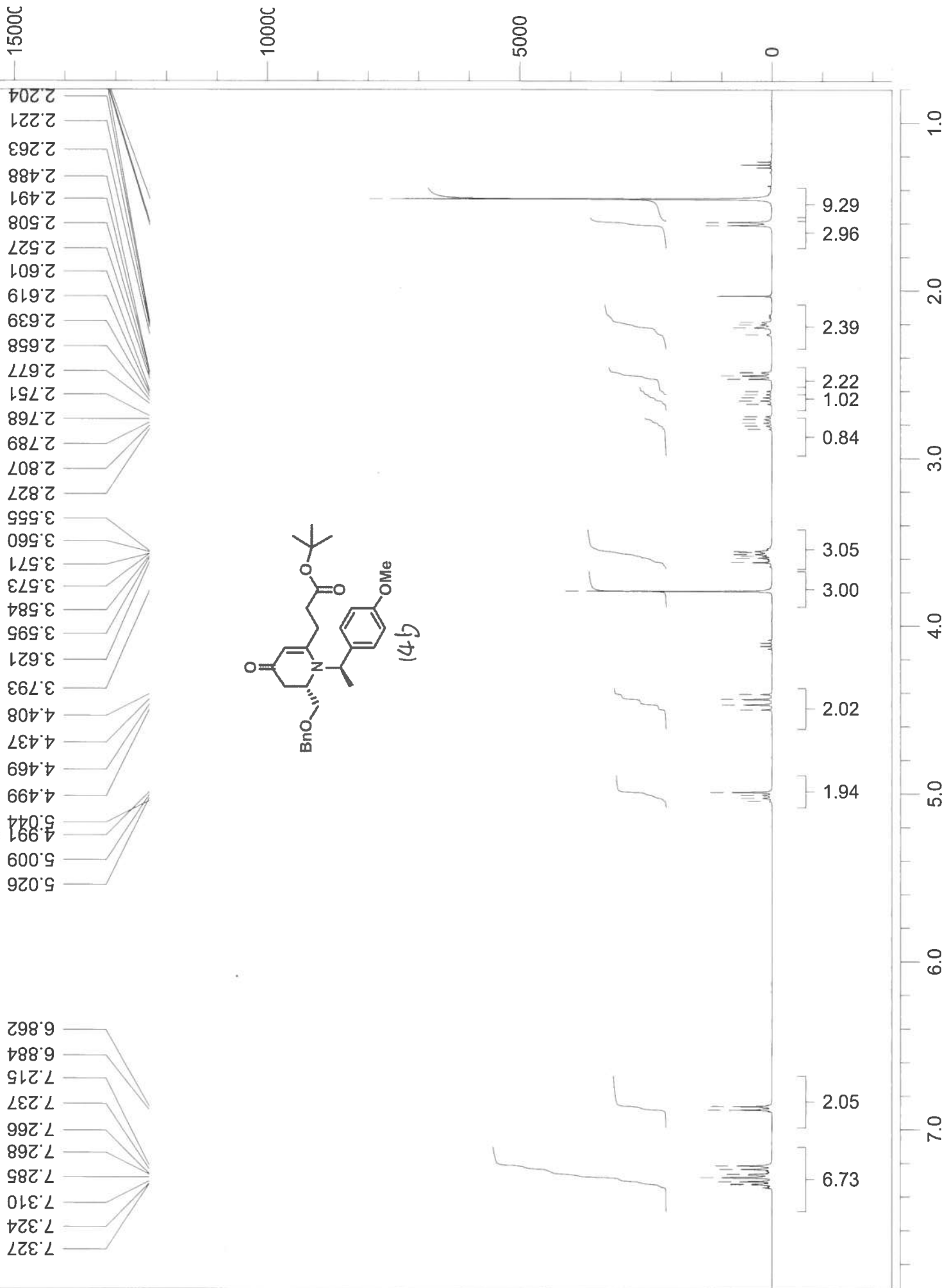
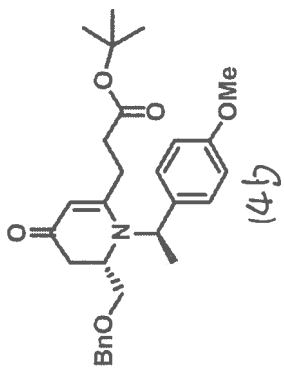

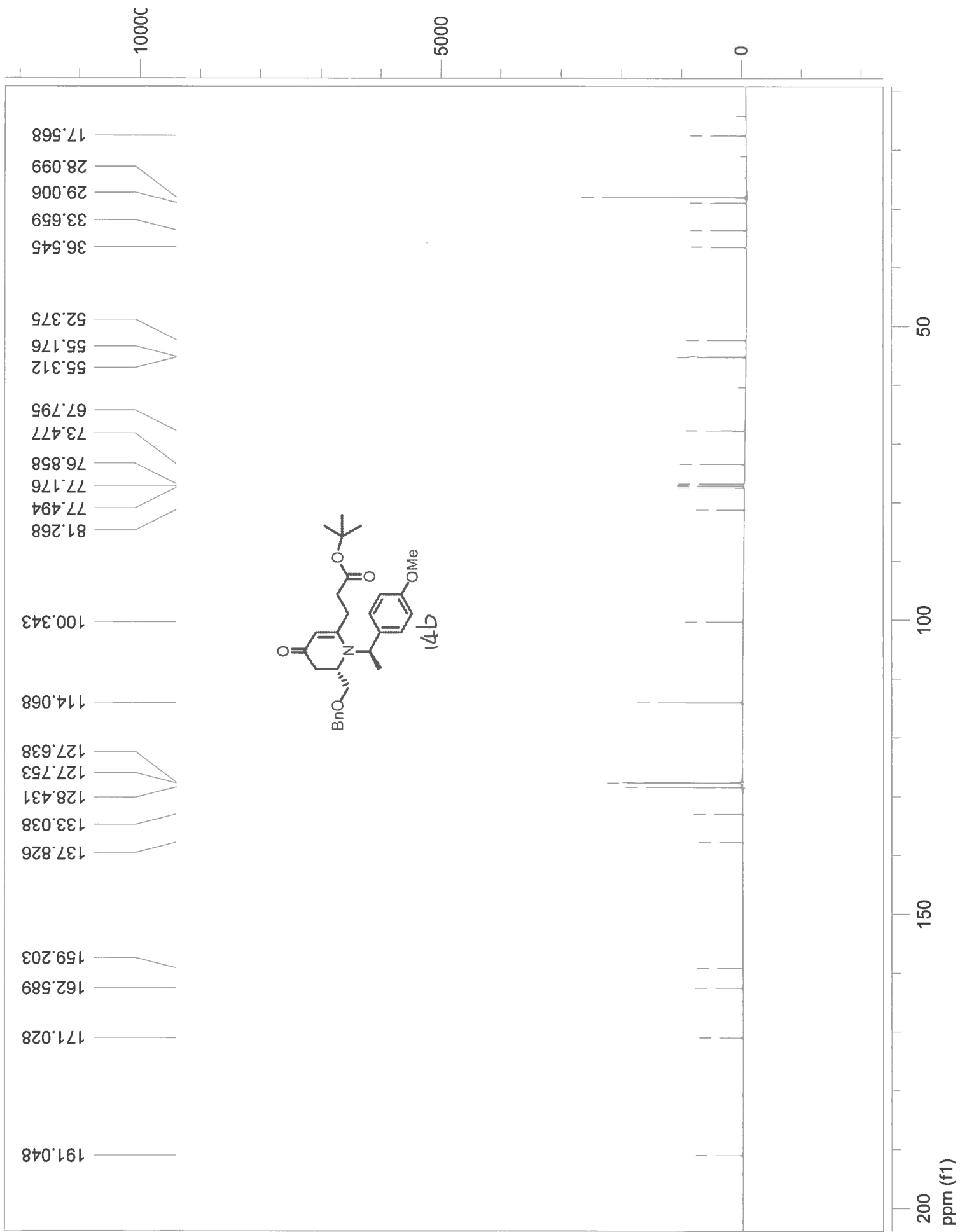
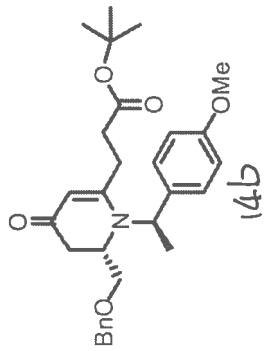

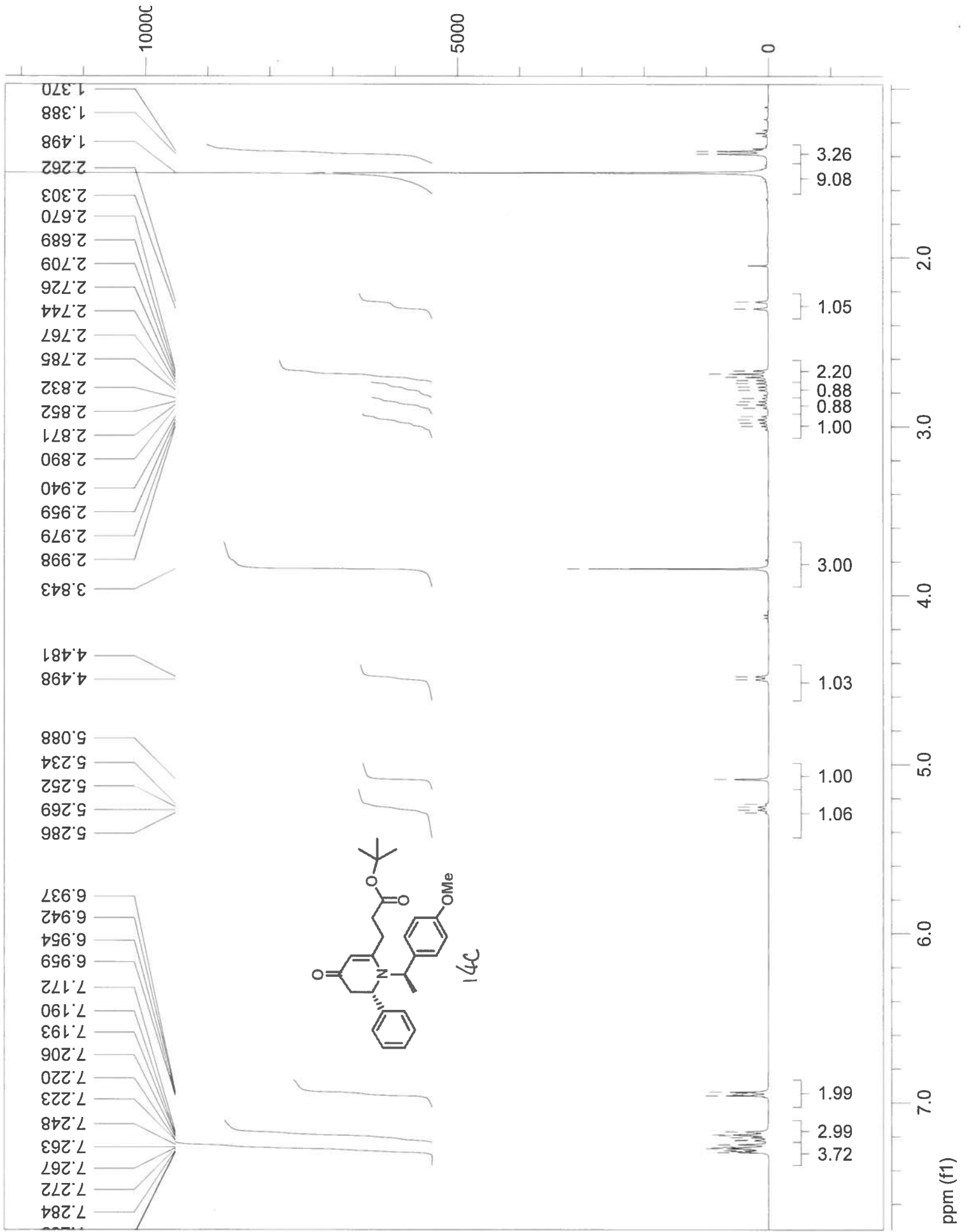

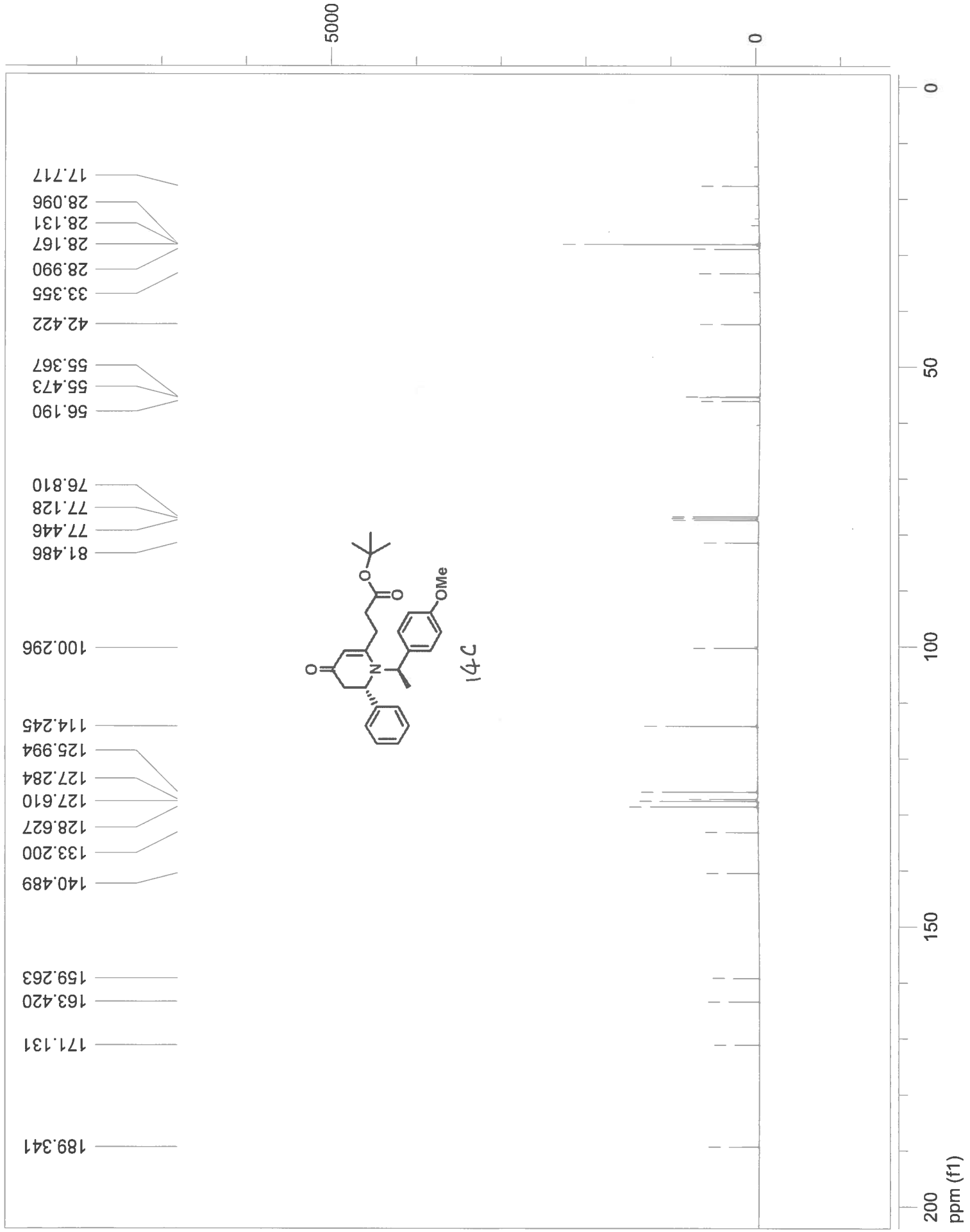

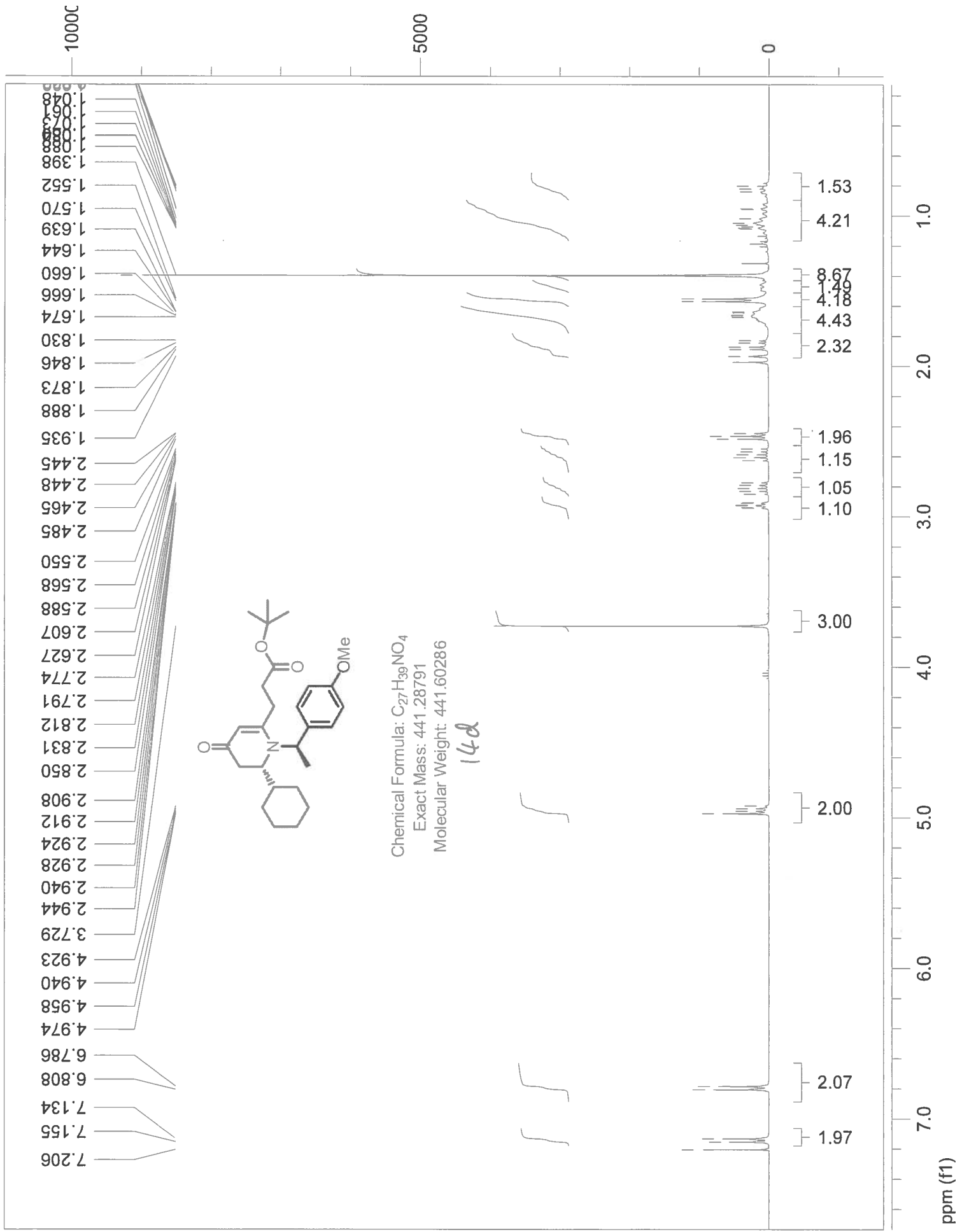

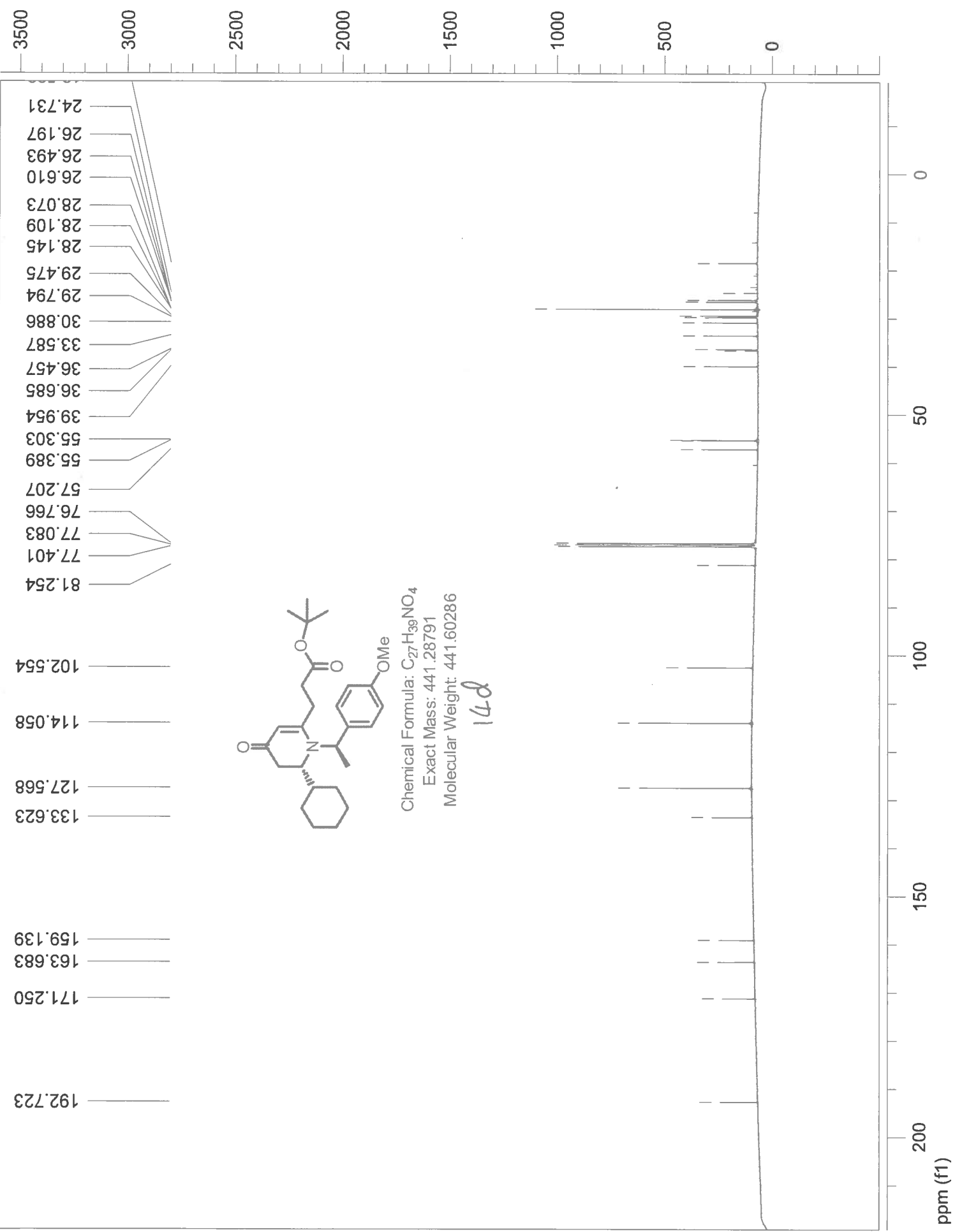

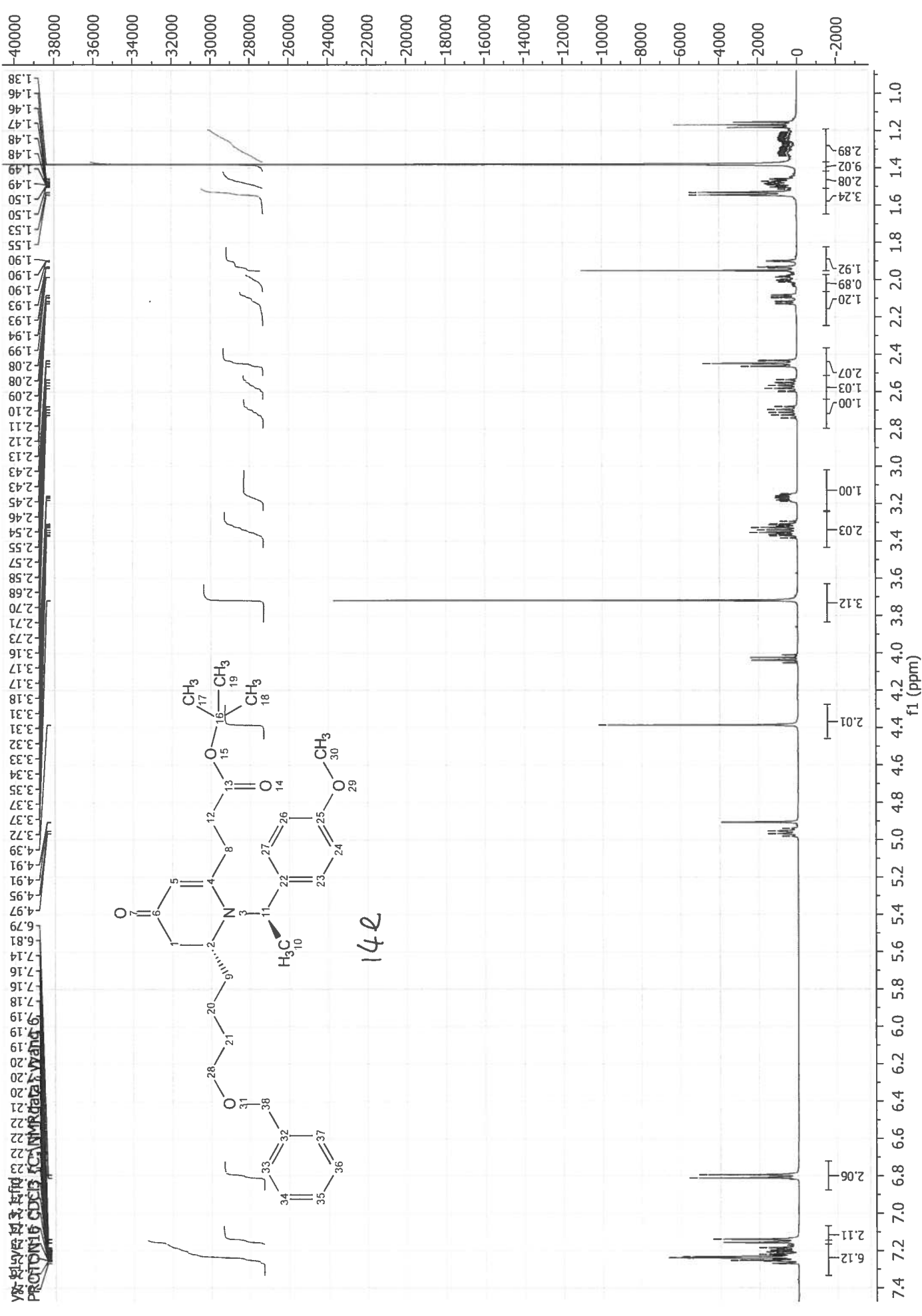

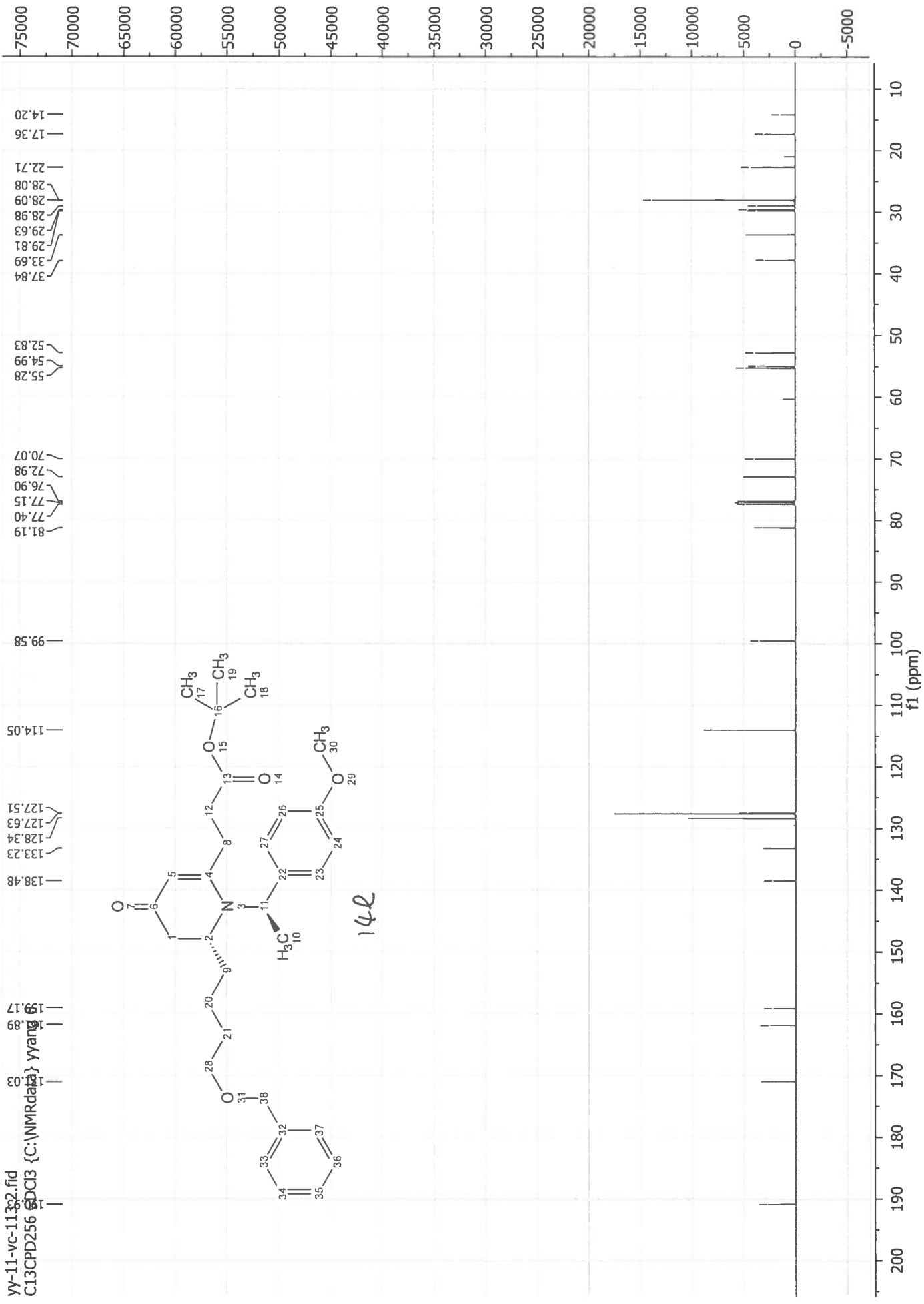

yy-11-vc-1132.fid
 C13CPD256 {C:\NMRdata\} yyang 6

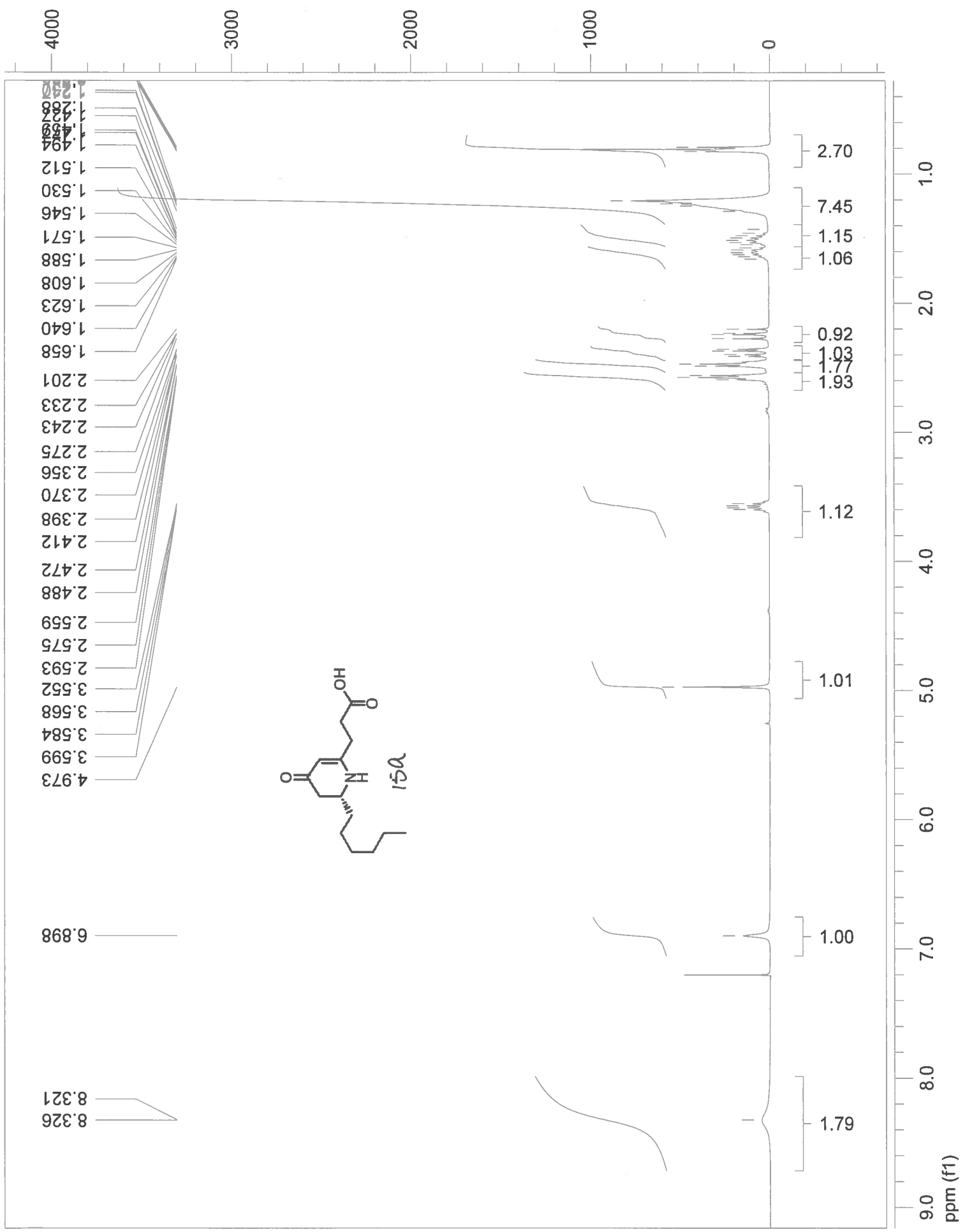

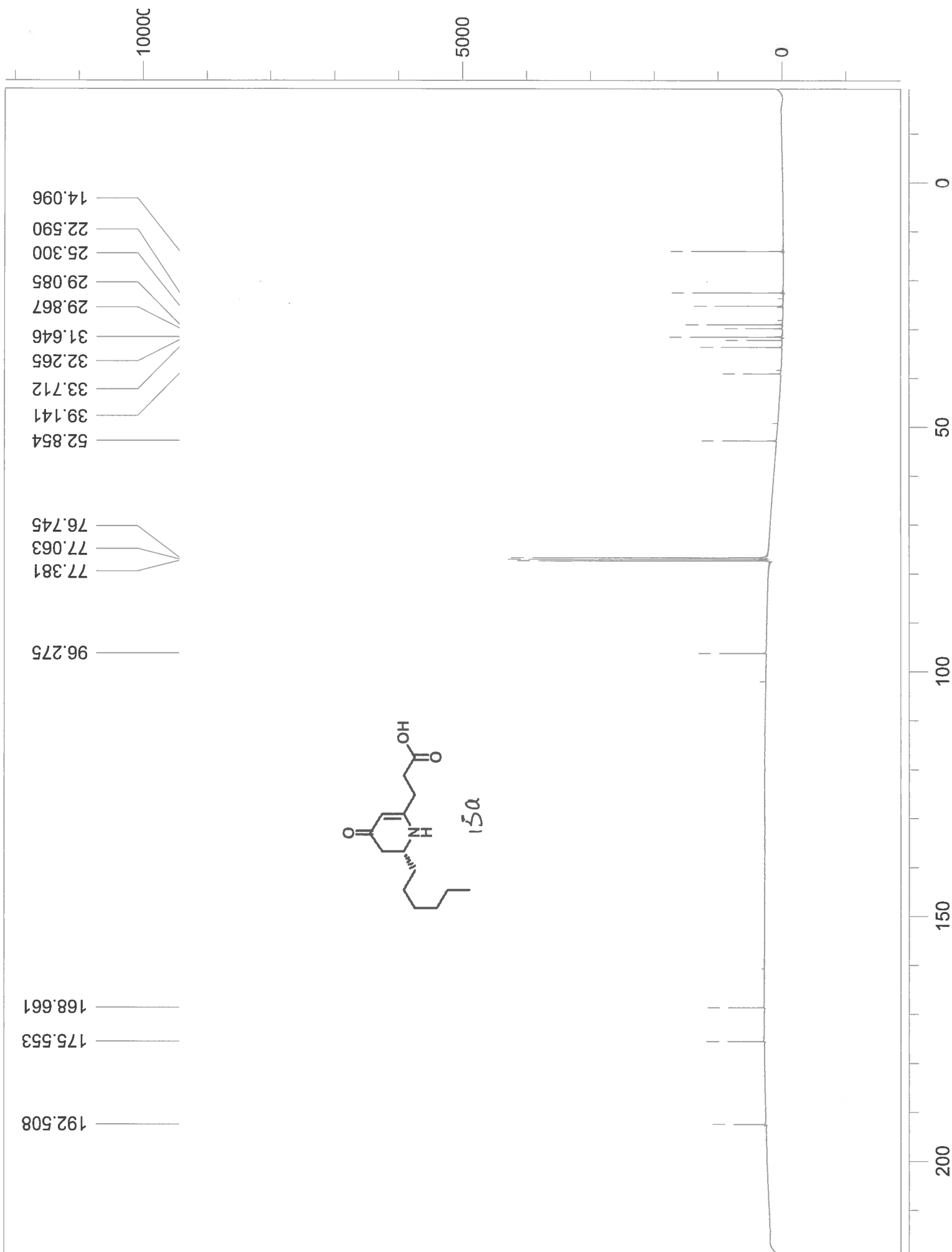

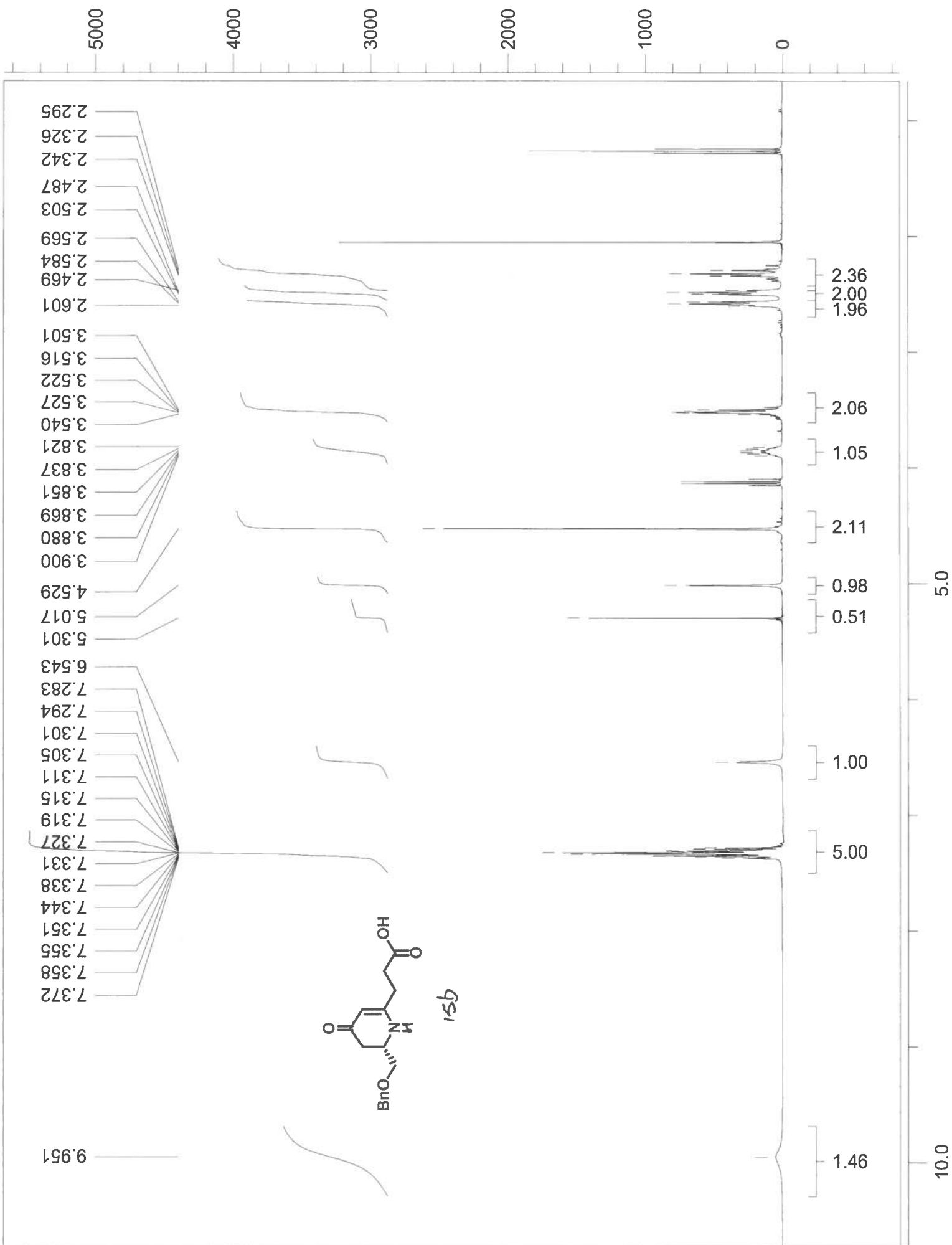

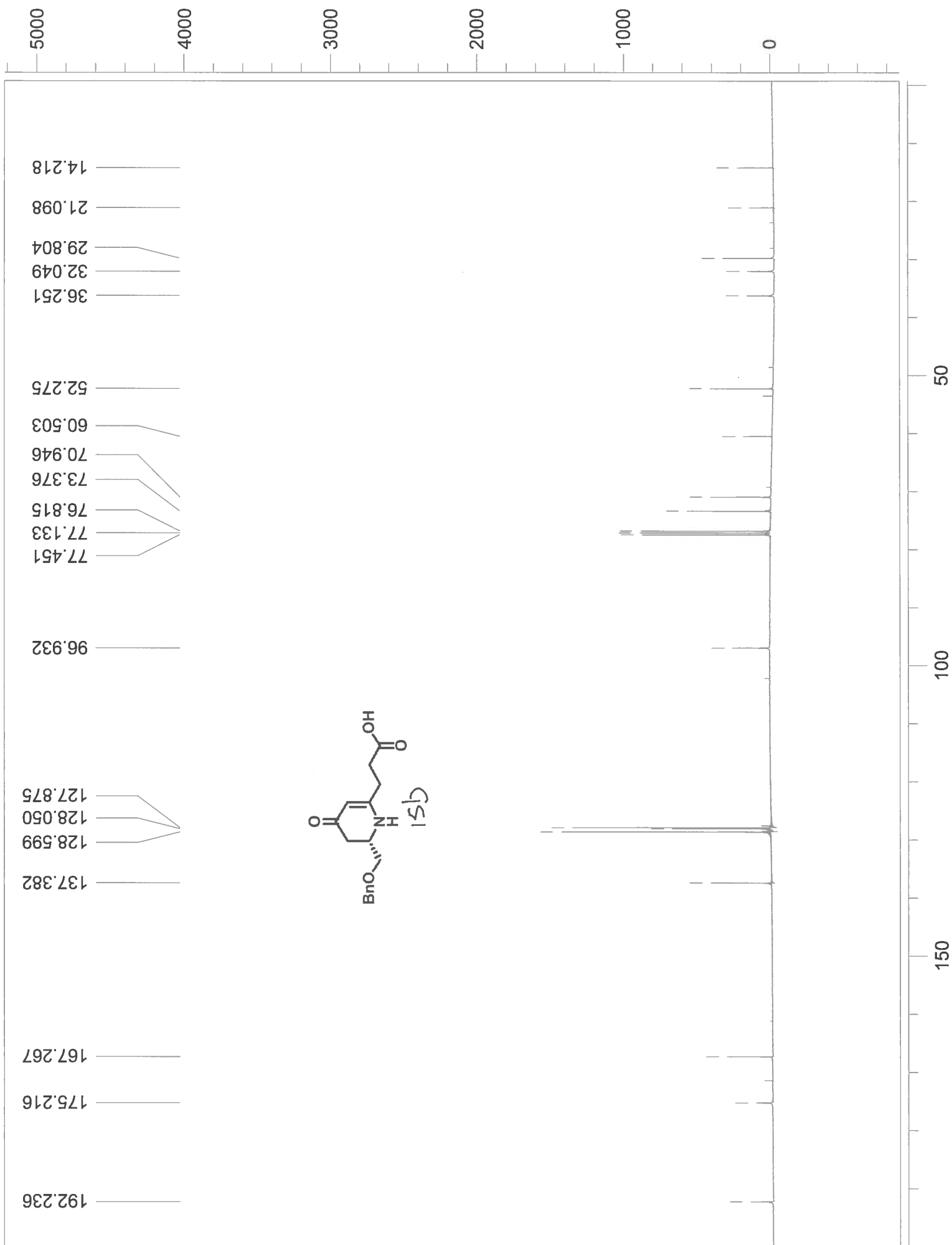

1000C

5000

0

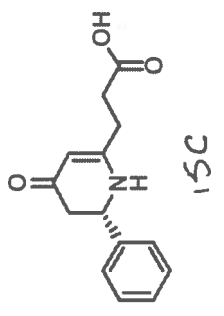

0.94
2.88
1.25

8.41

1.00

1.01
3.67

3.0

4.0

5.0

6.0

7.0

ppm (f1)

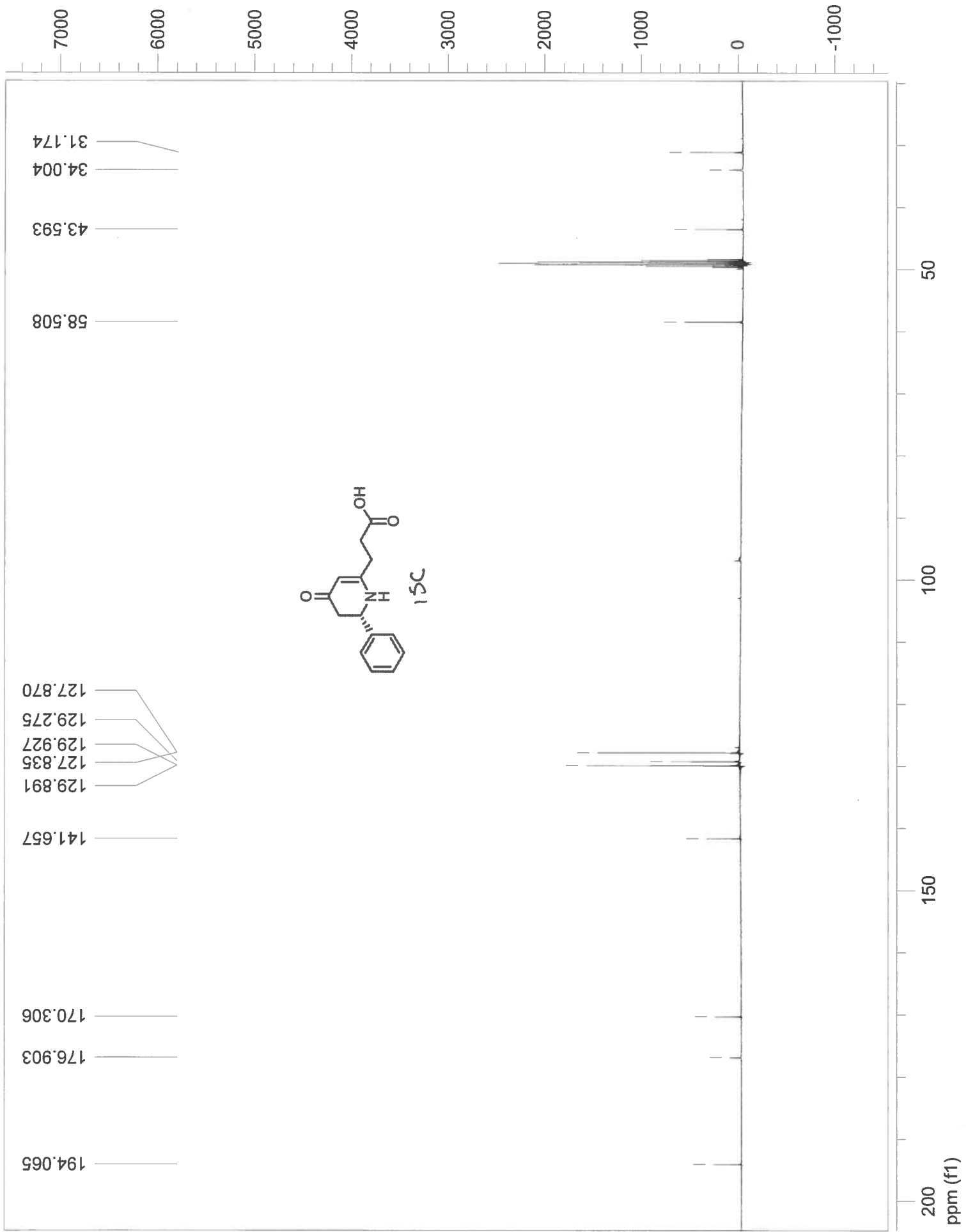

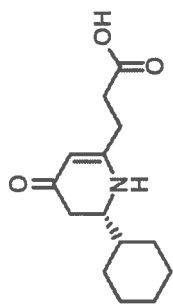

15d

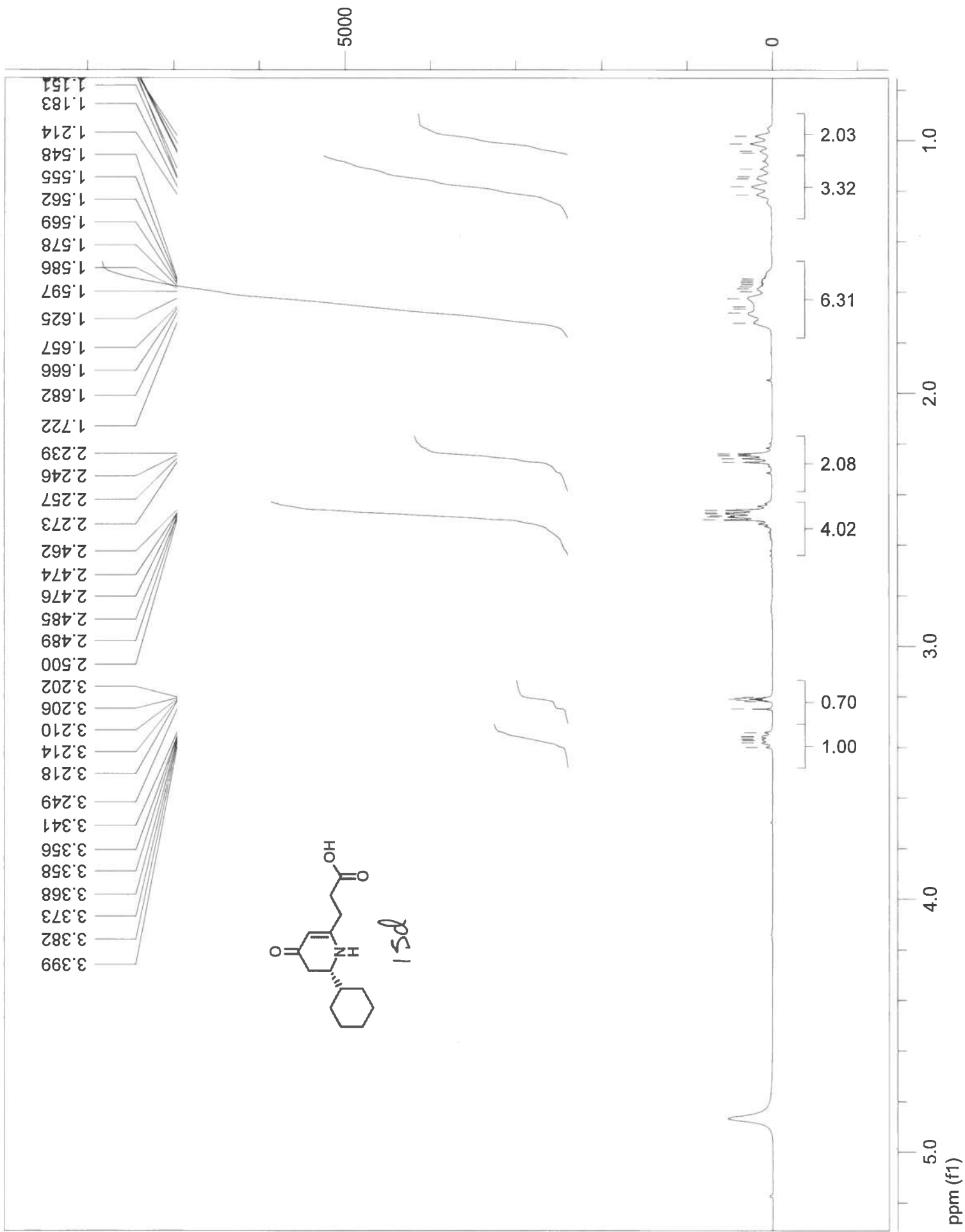

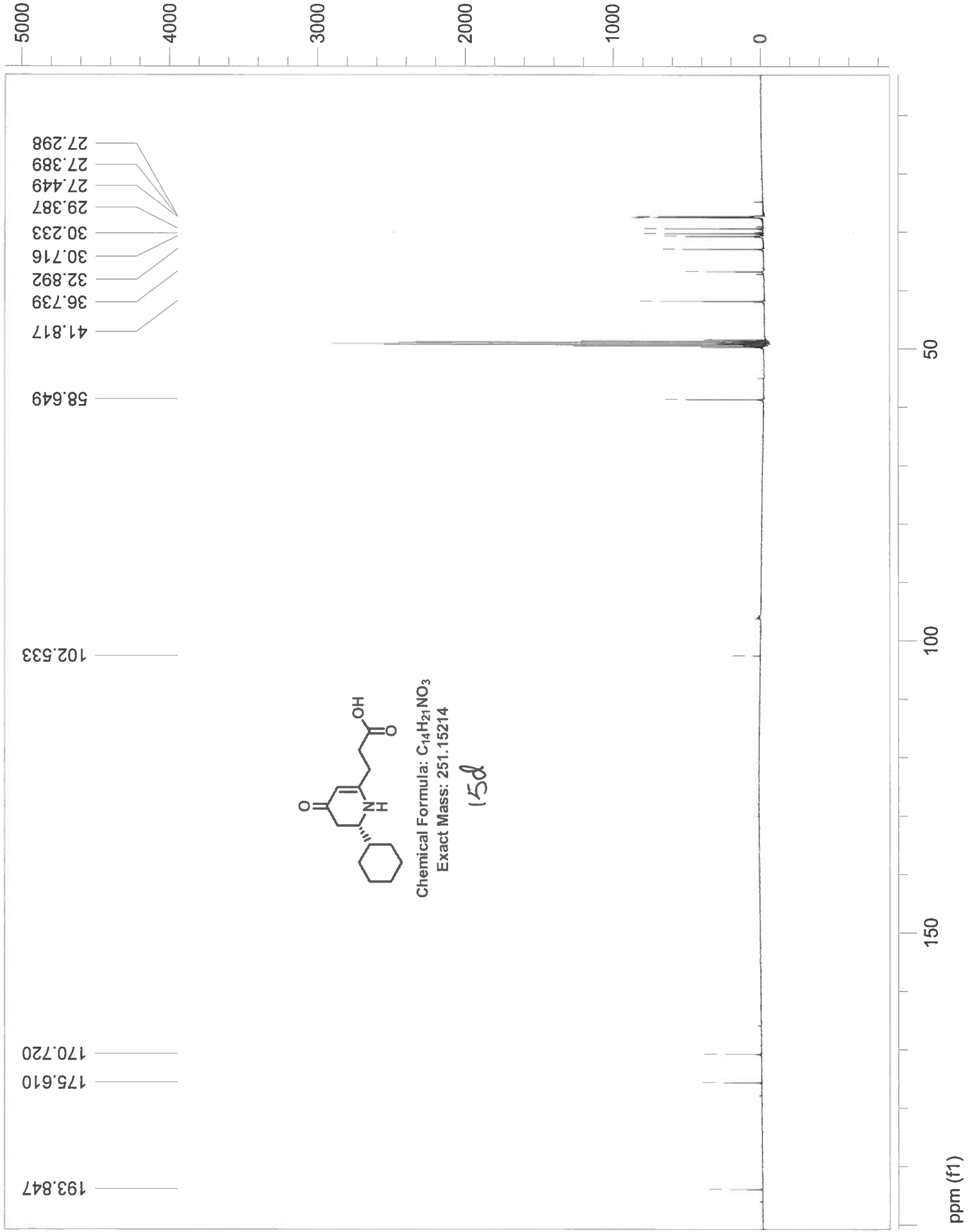

Waktu: 18.13.00
PROTON 1D CDCl₃ C: WIRIDATAY Yang 8

Handwritten notes: "H" and "H" with arrows pointing to the chemical structure.

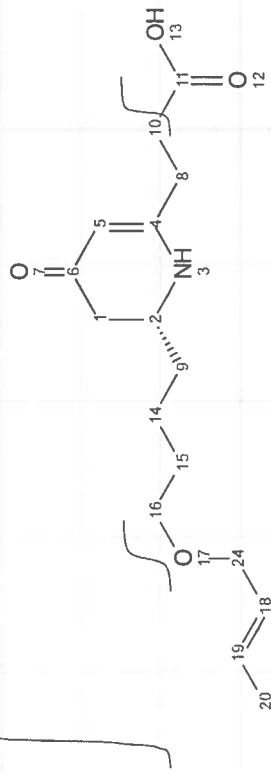

152

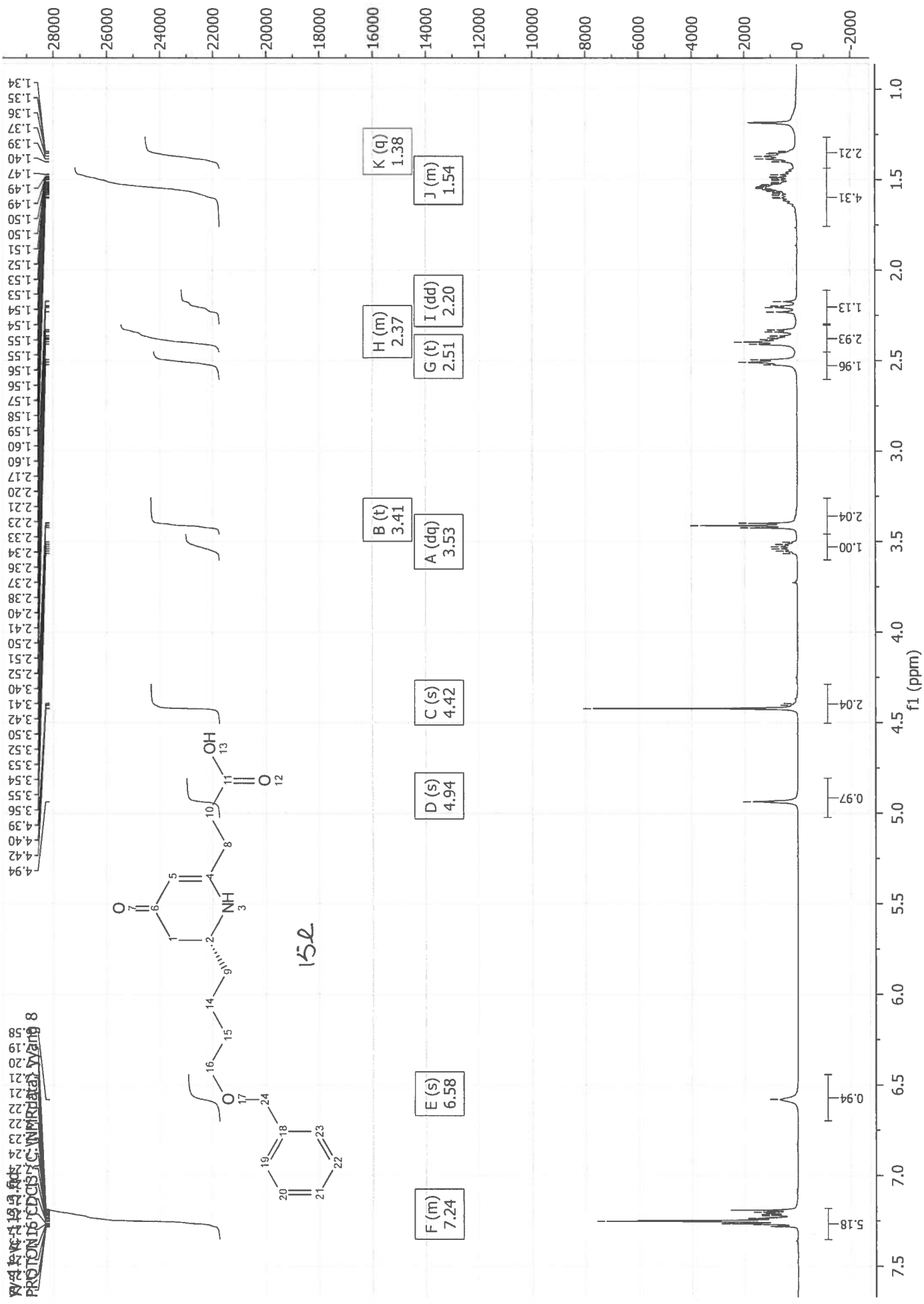

W-81-vc-113.4.fid
C:\S\PD256 CDC13 {C:\NMR\data} \yyang 8

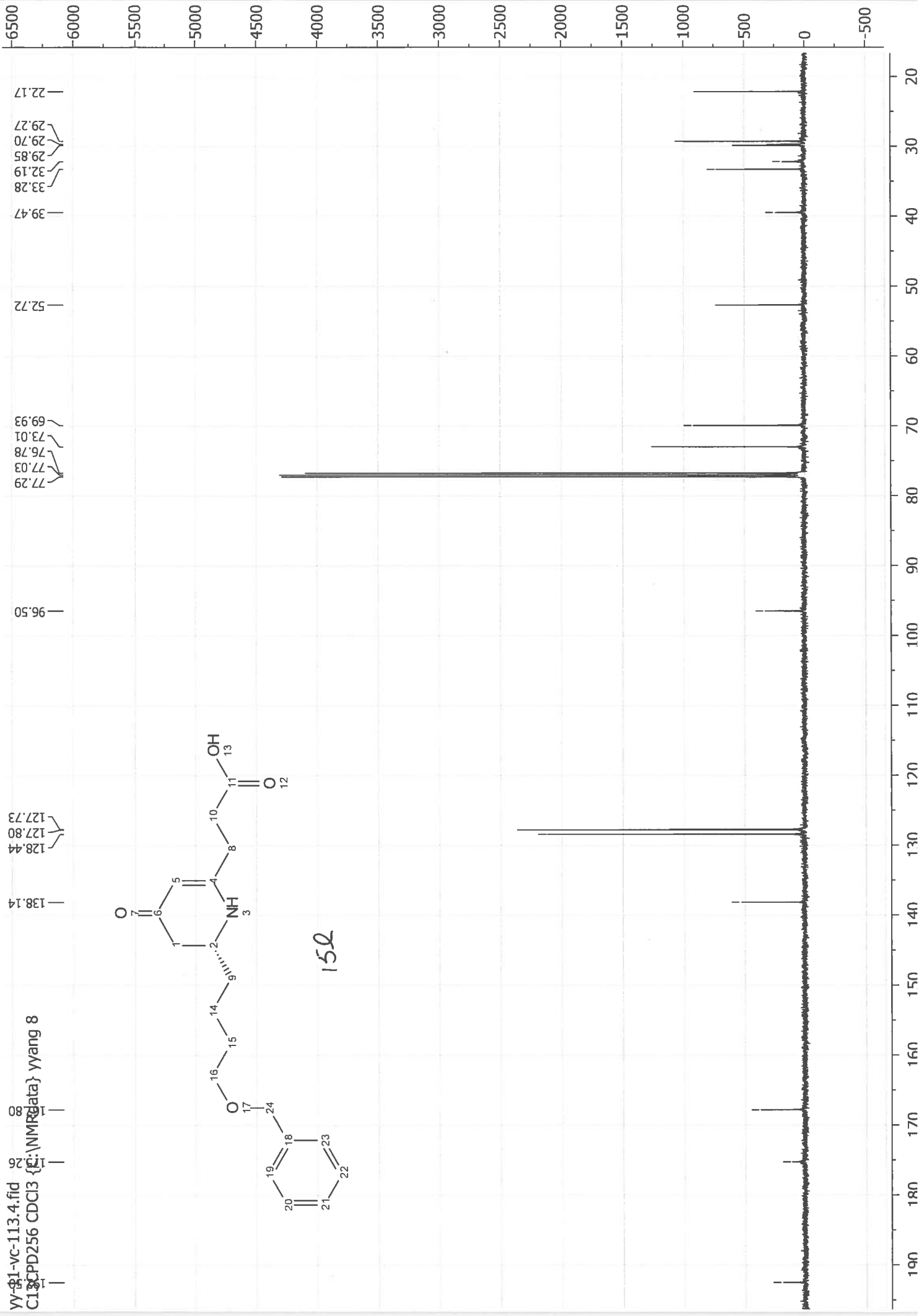

150

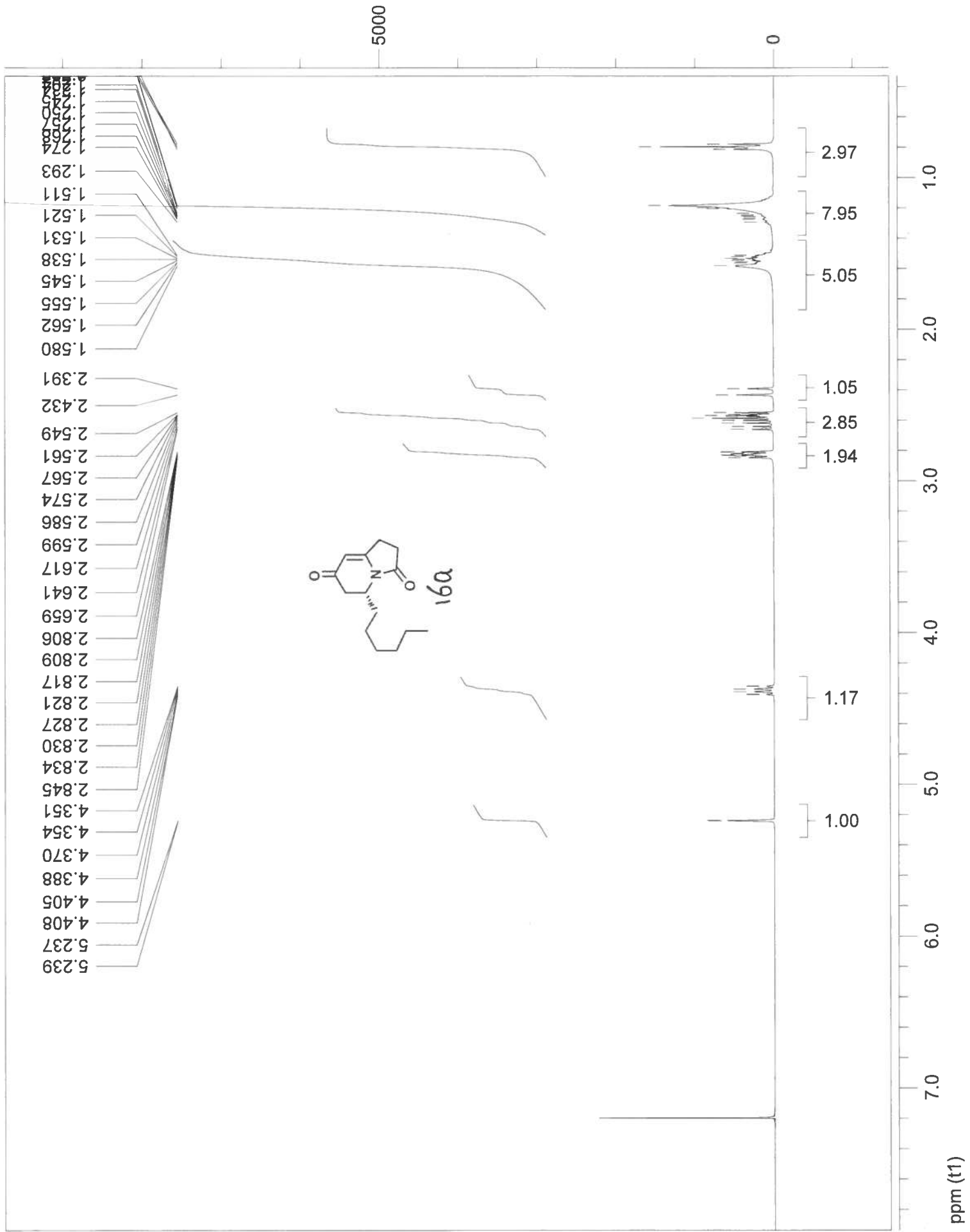

1D — YY-8-VC-14.2.fid —

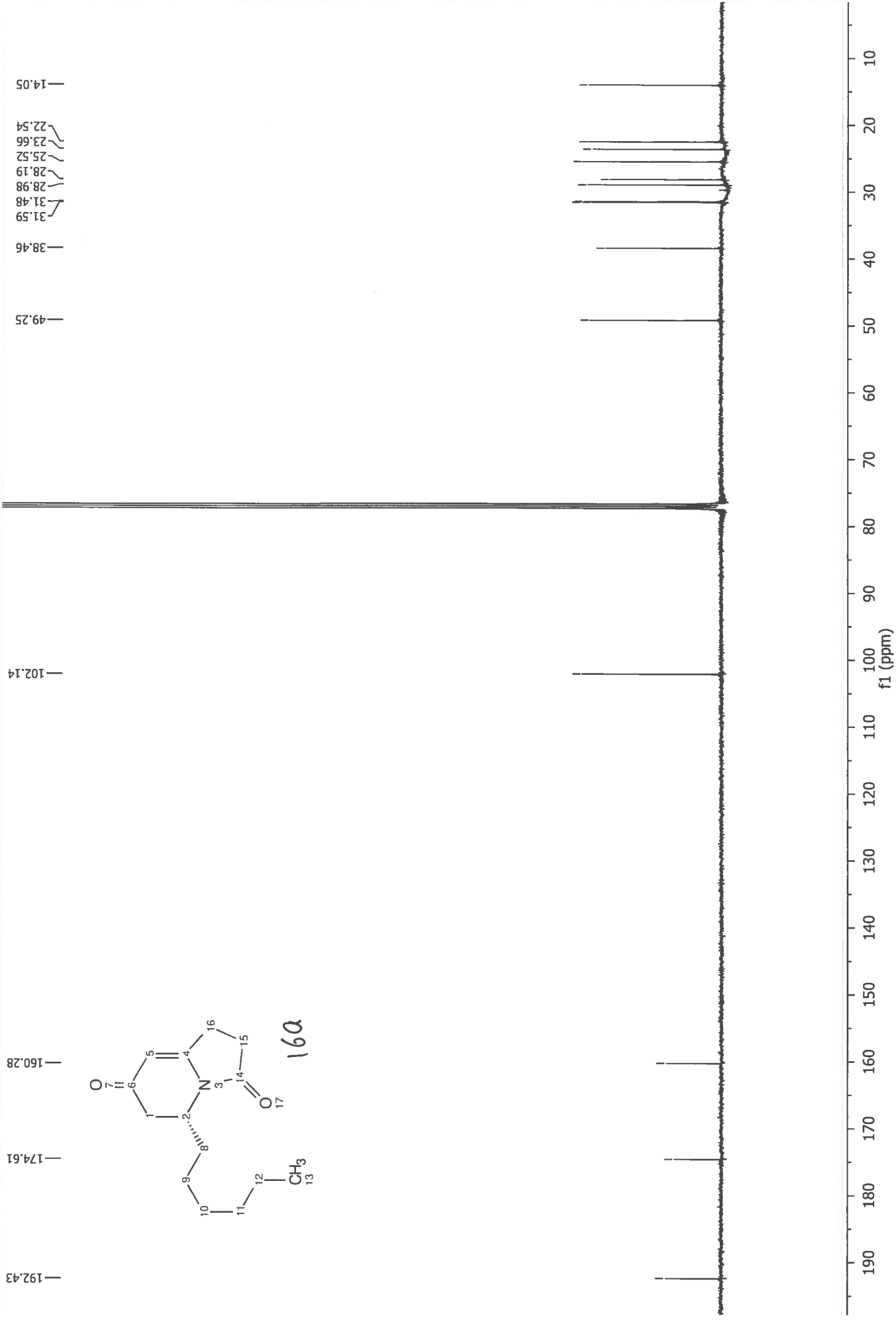

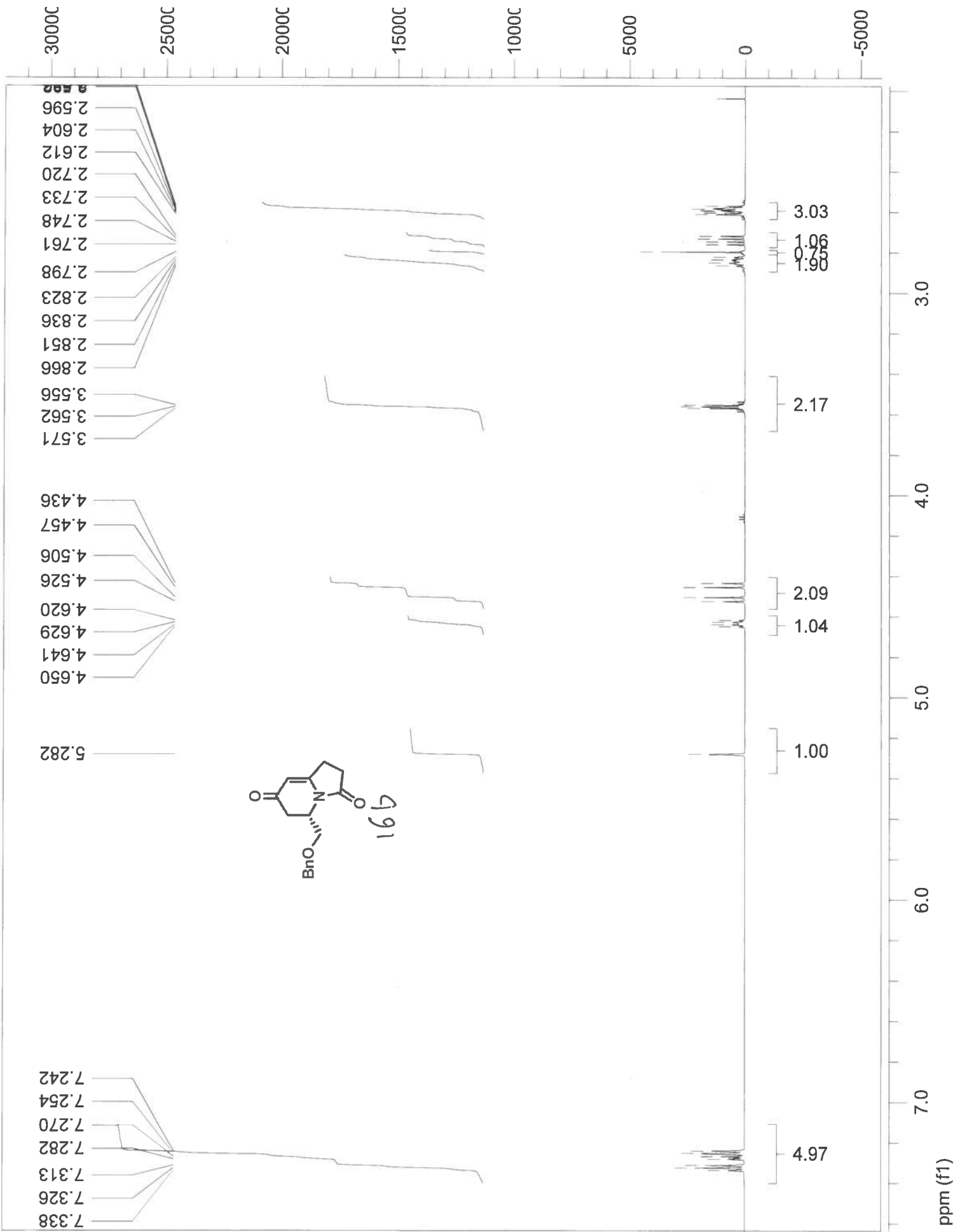

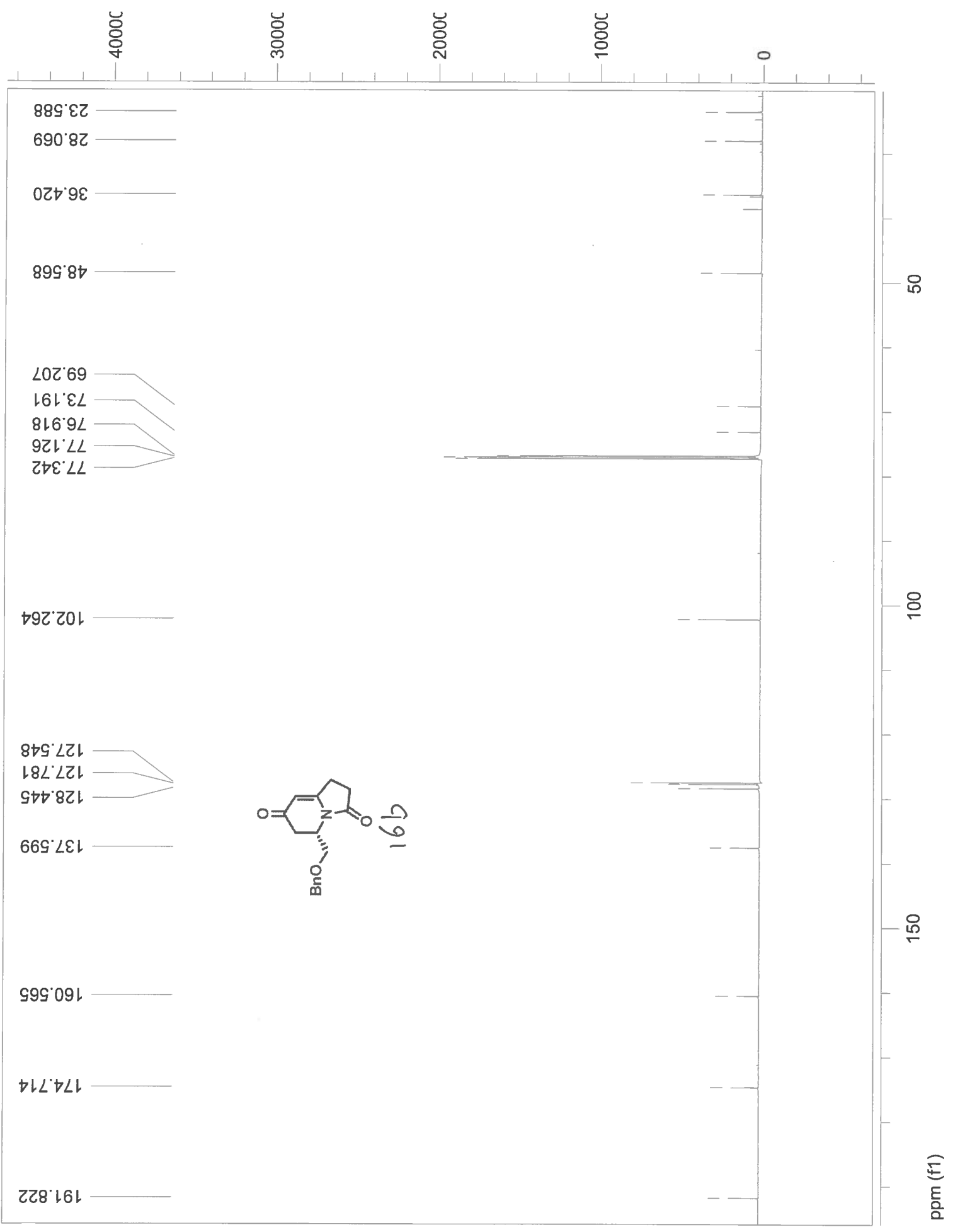
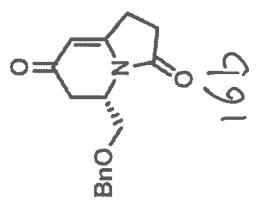

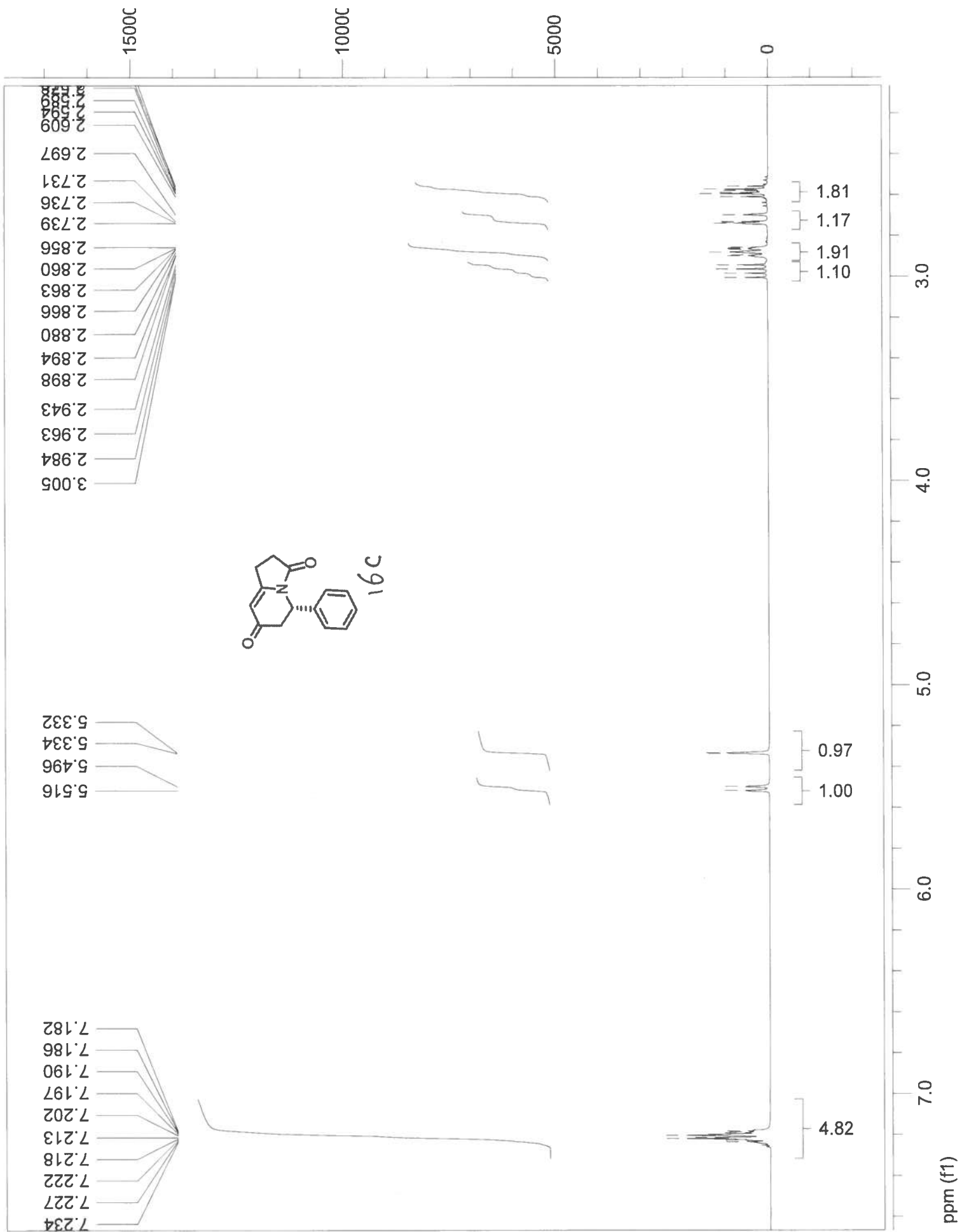

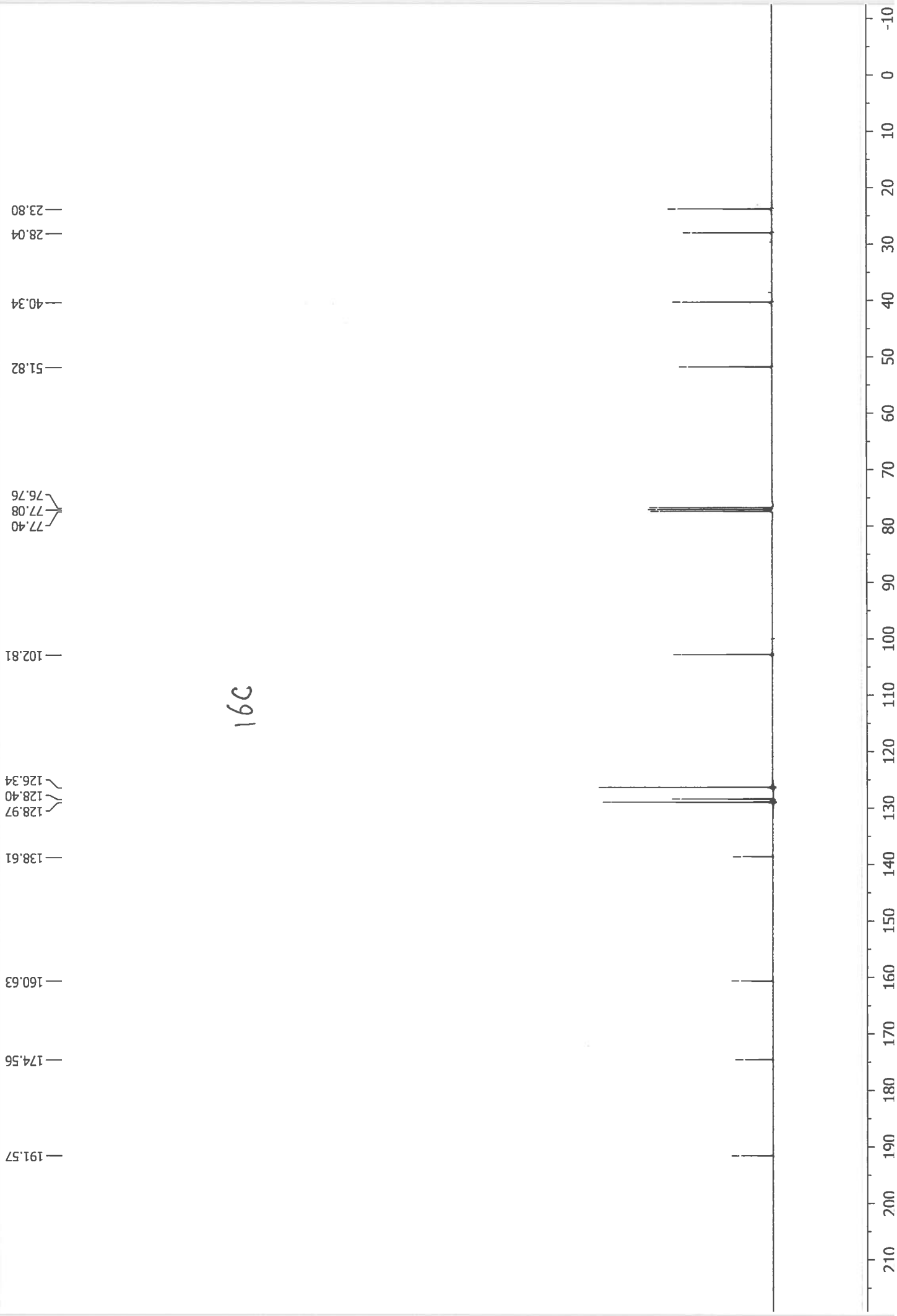

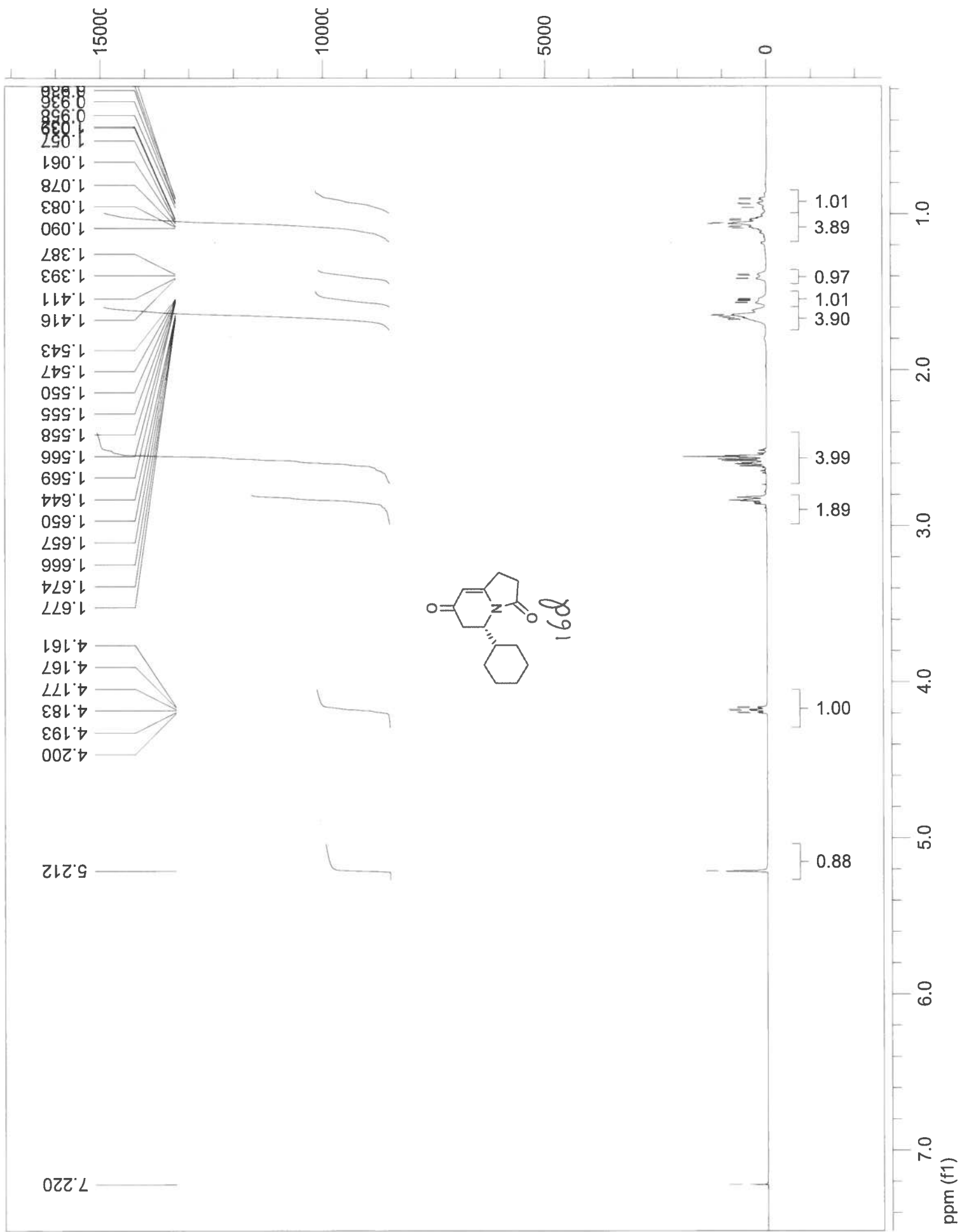

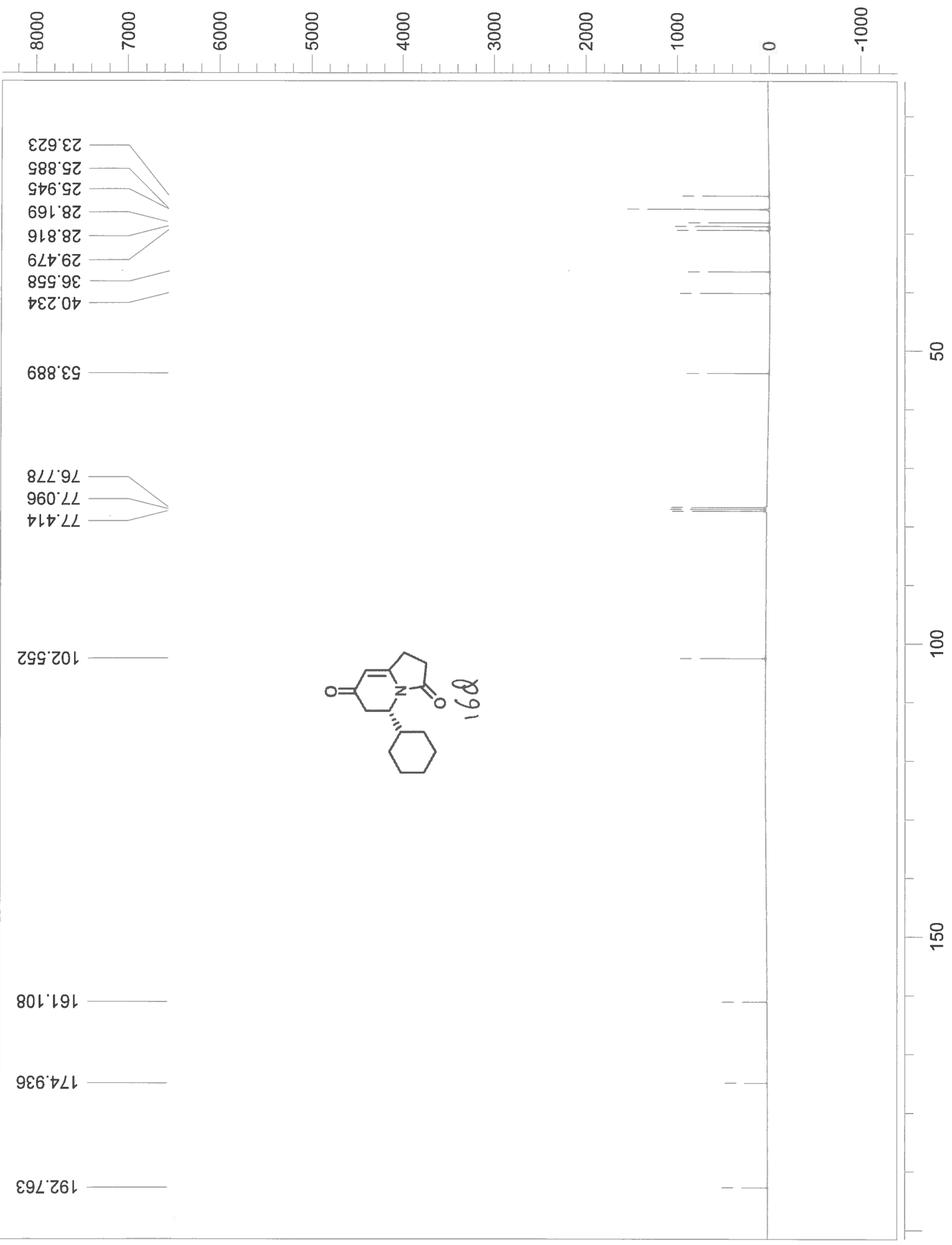

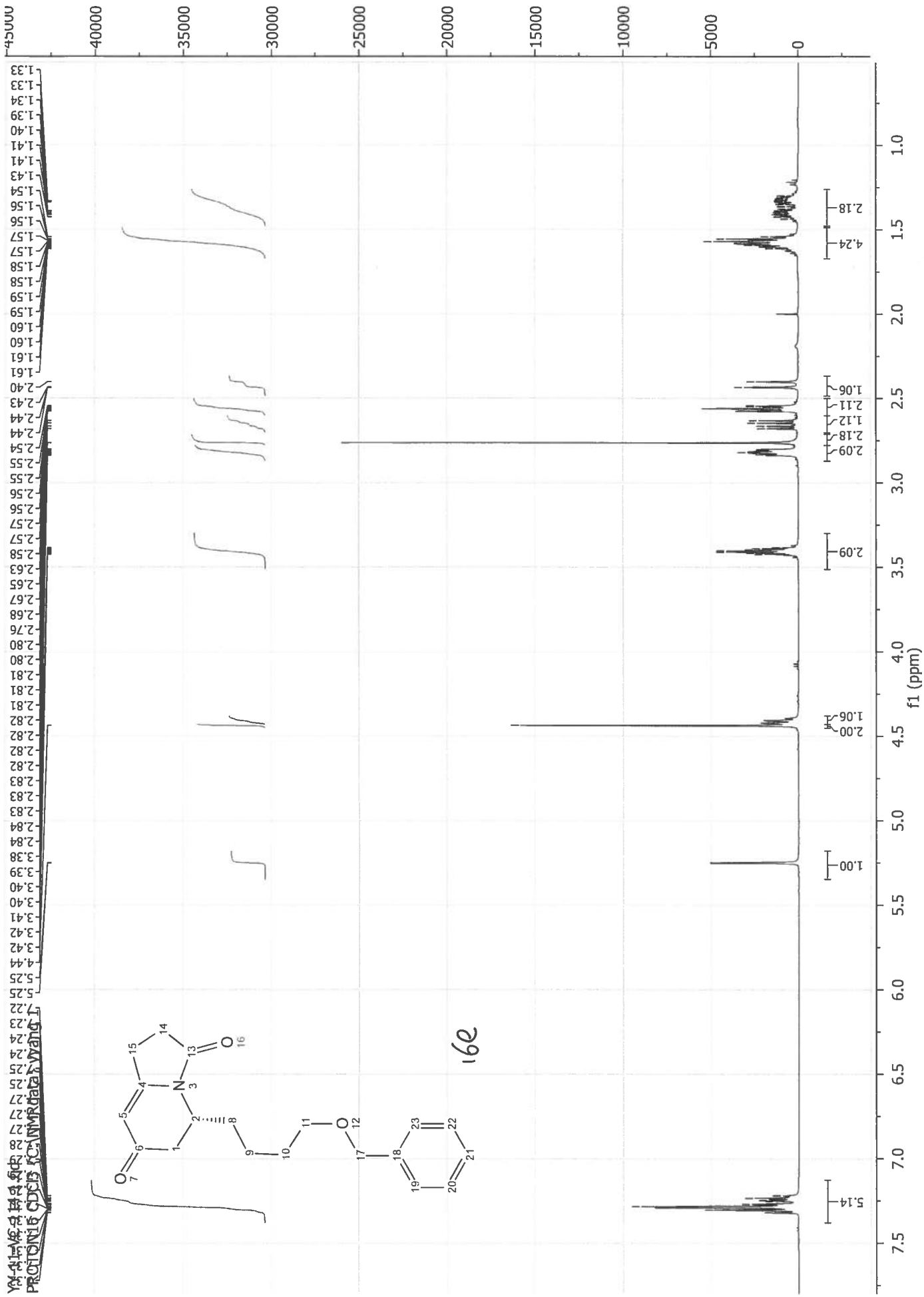

YAN LIANG, ZHANG QIANG
 PROTON 16 CD15 SC-MMRdata\16e

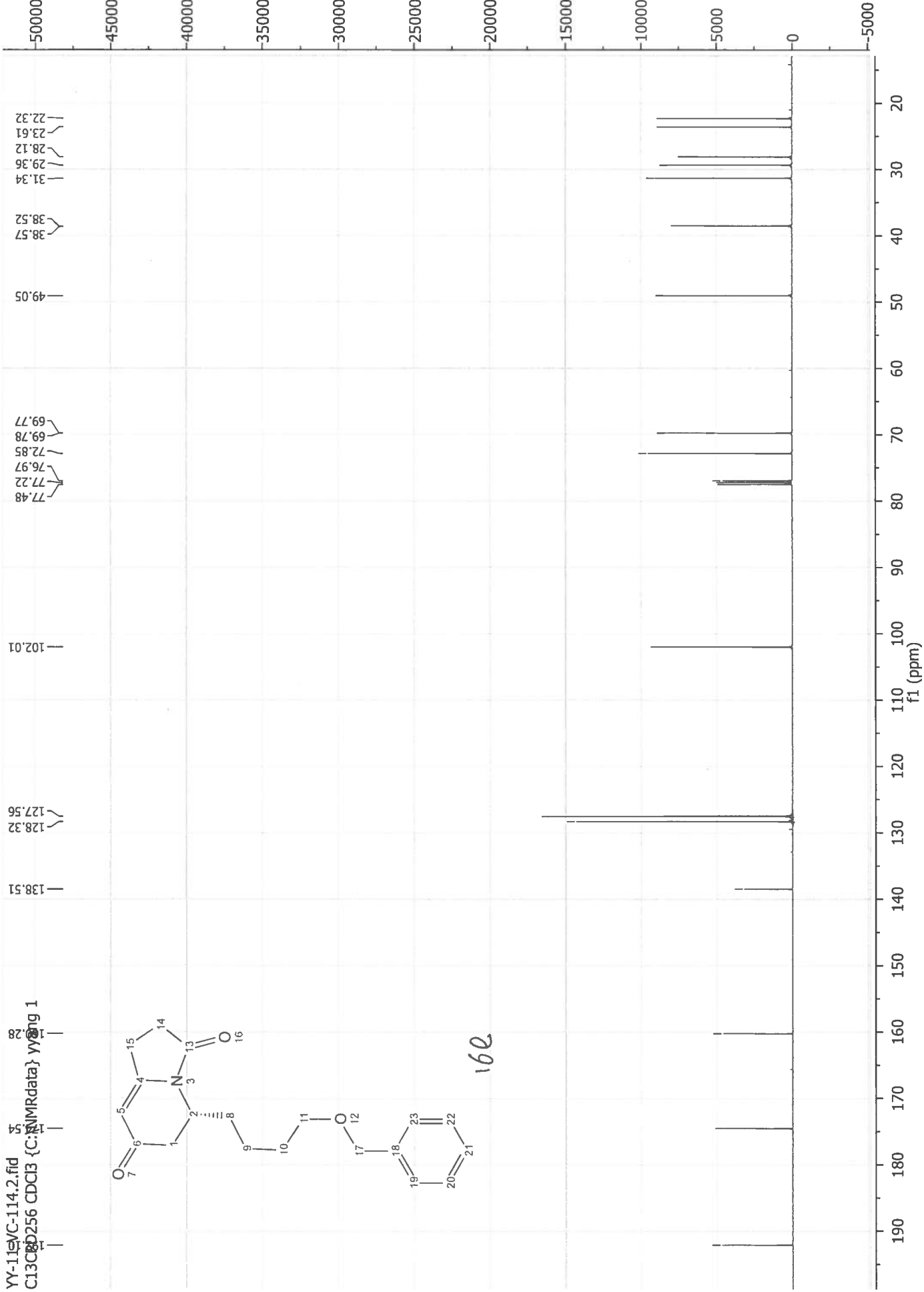

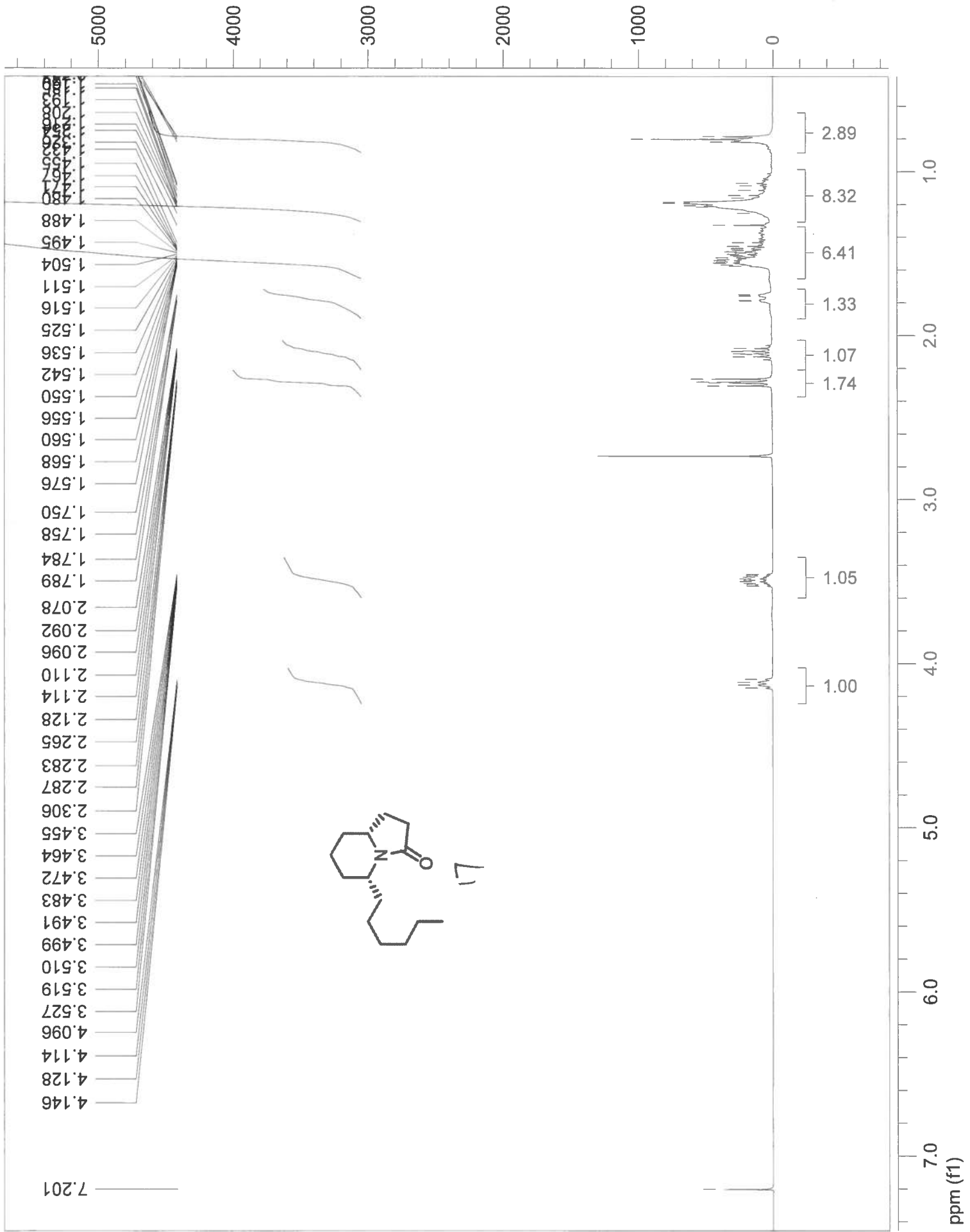

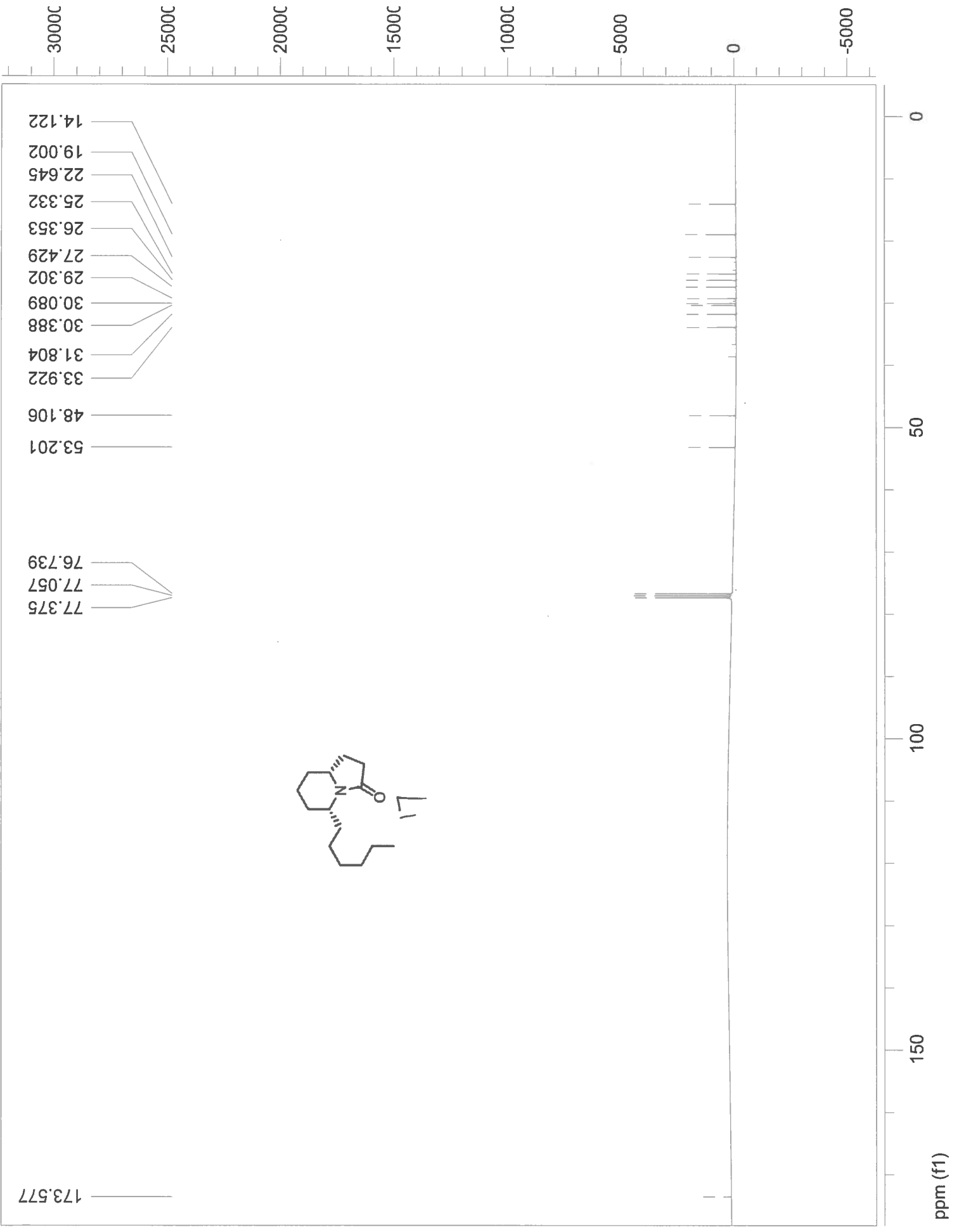

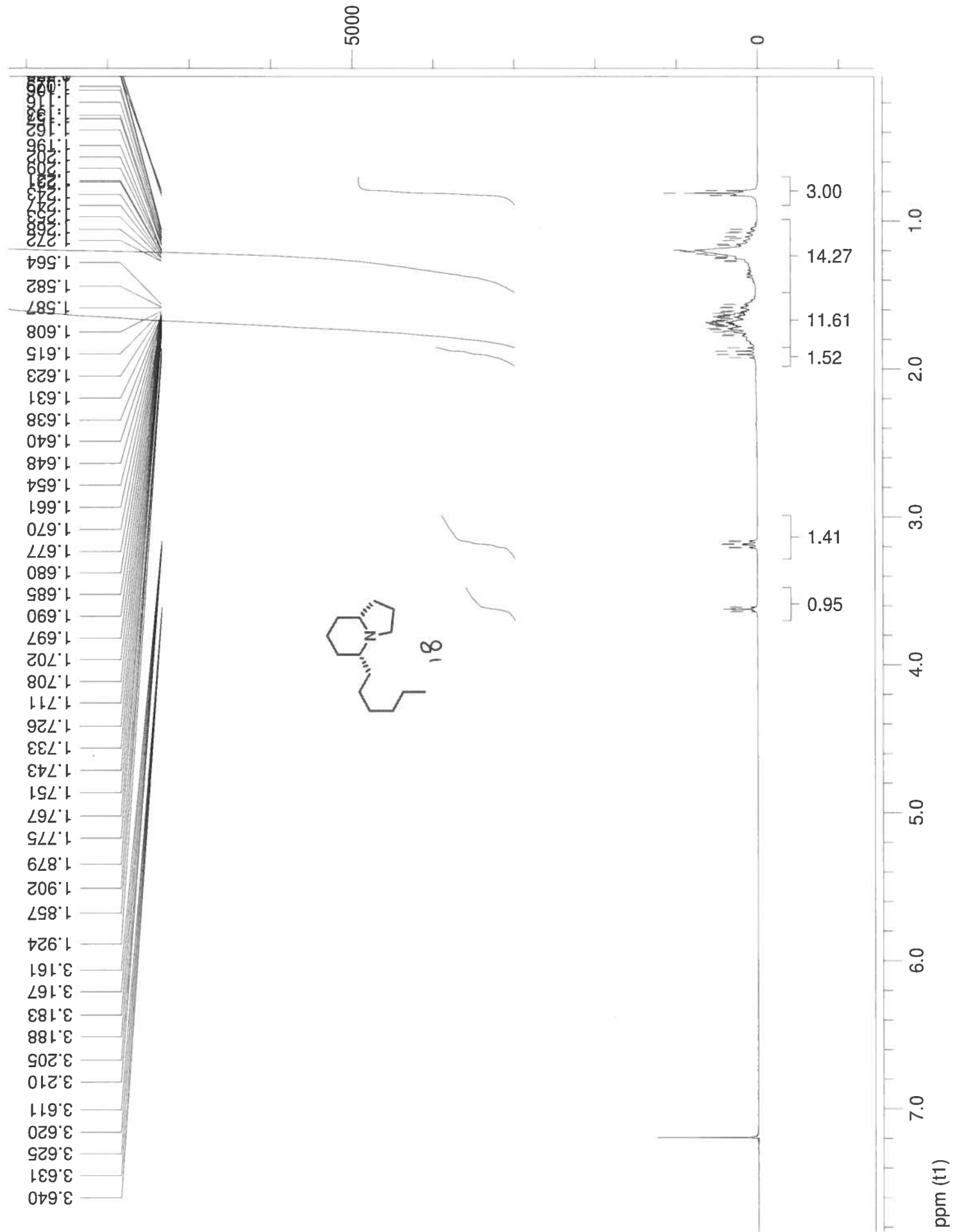

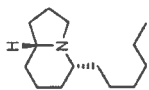

18
(-)-indolizidine209D

18

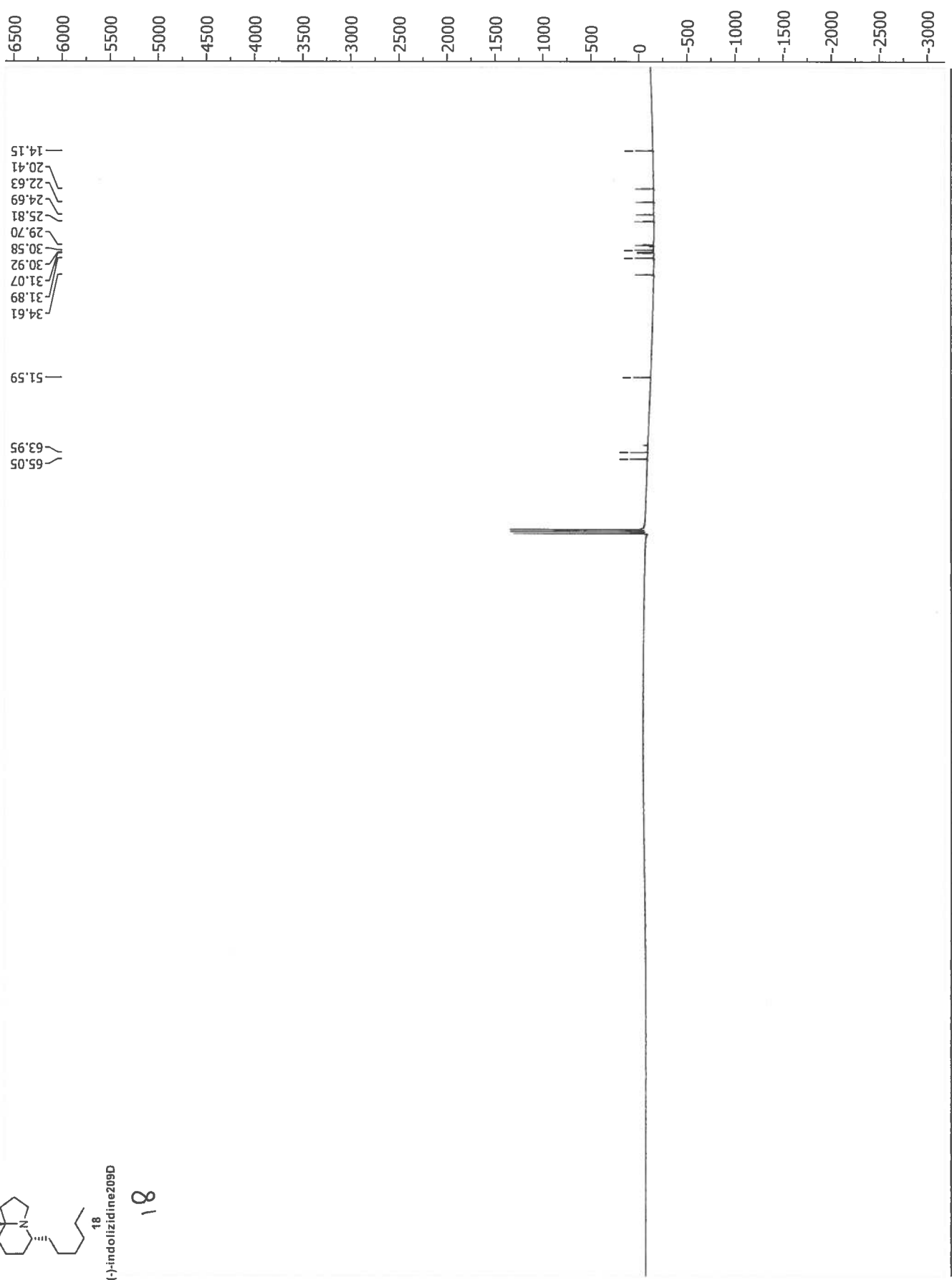

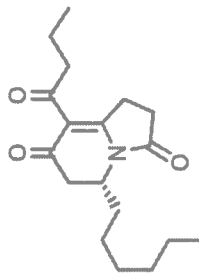

Chemical Formula: $C_{18}H_{27}NO_3$
 Exact Mass: 305.19909
 Molecular Weight: 305.41800

19

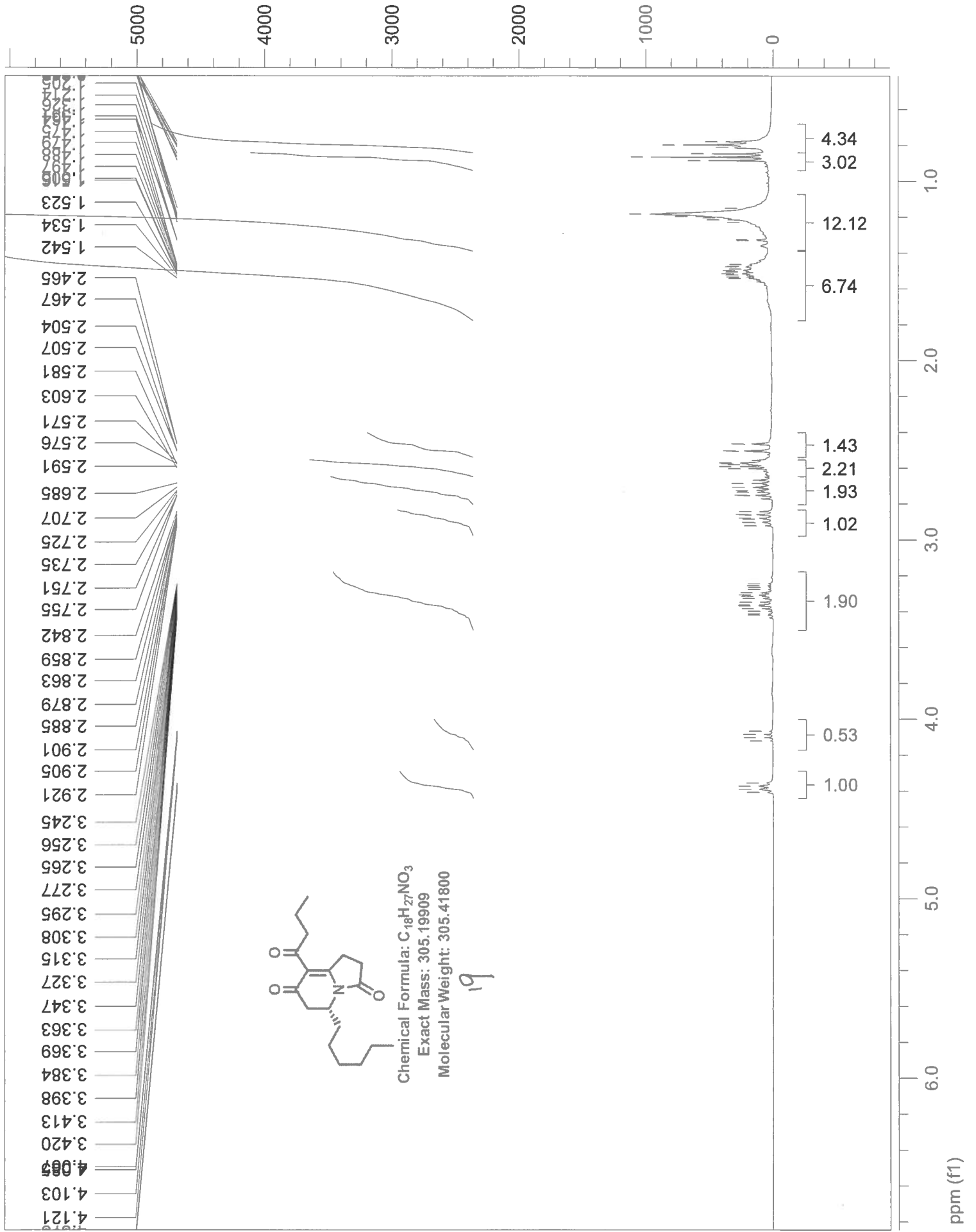

1D — yy-vc-39.2.fid —

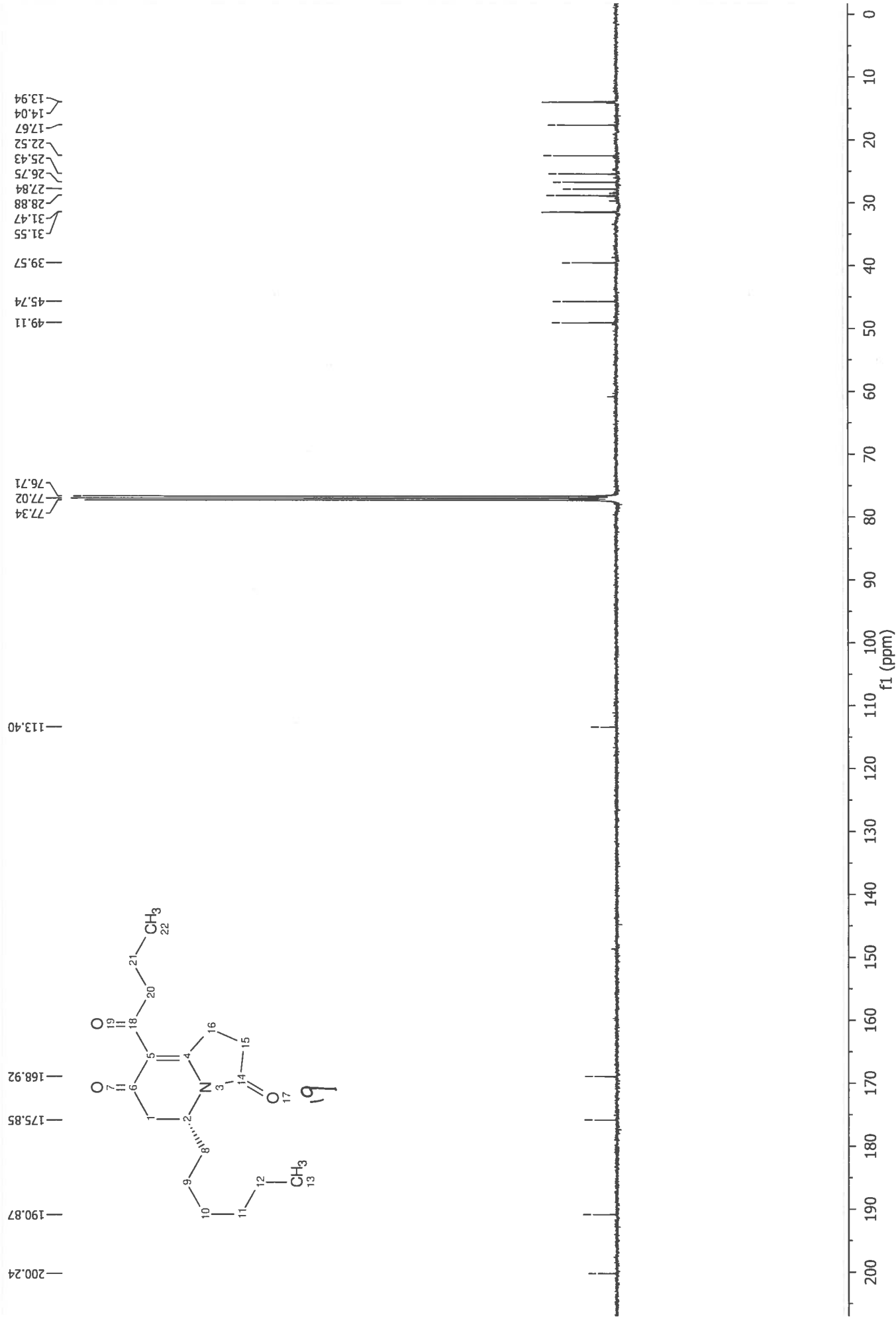

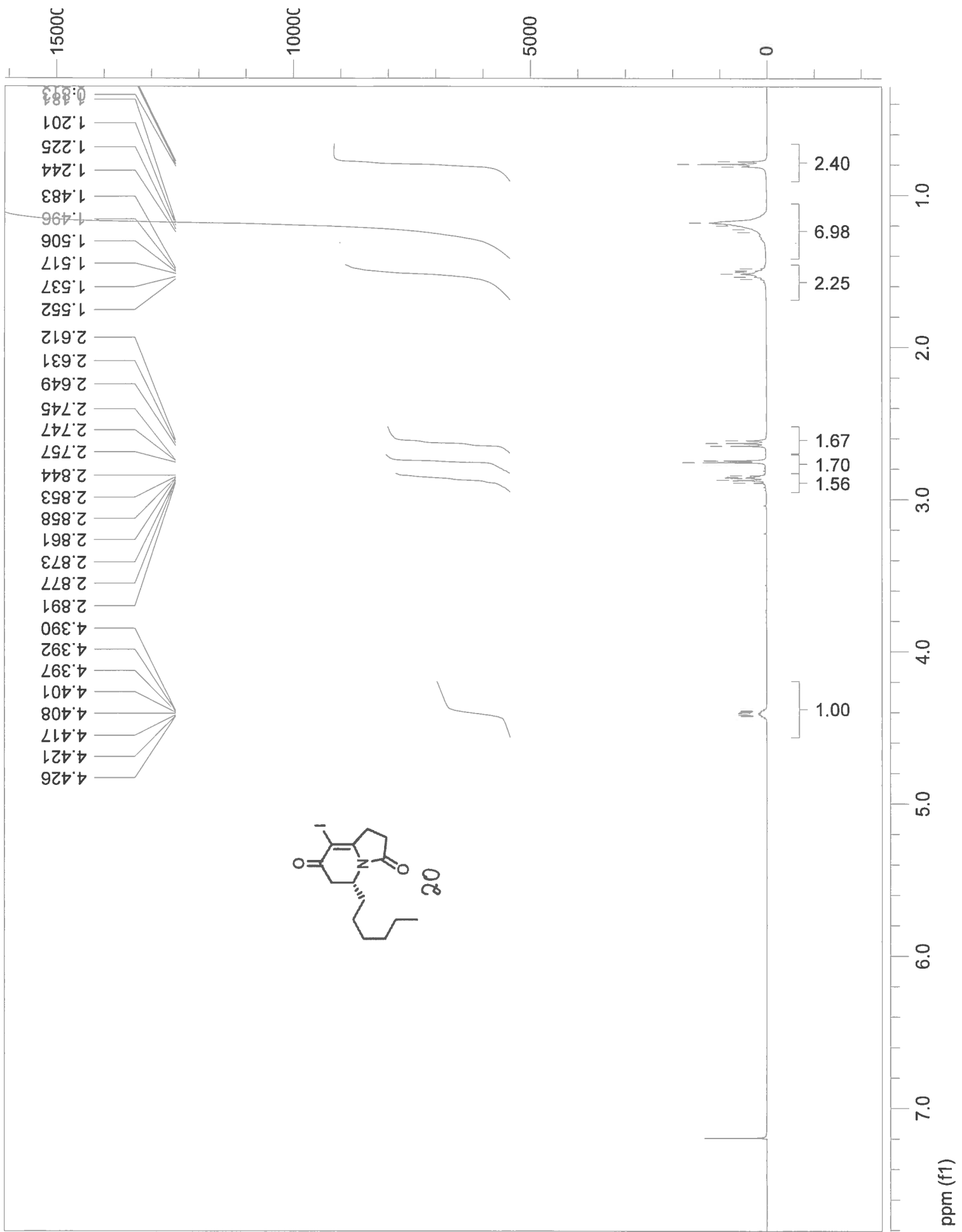

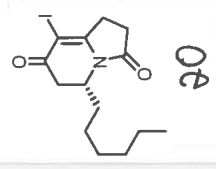
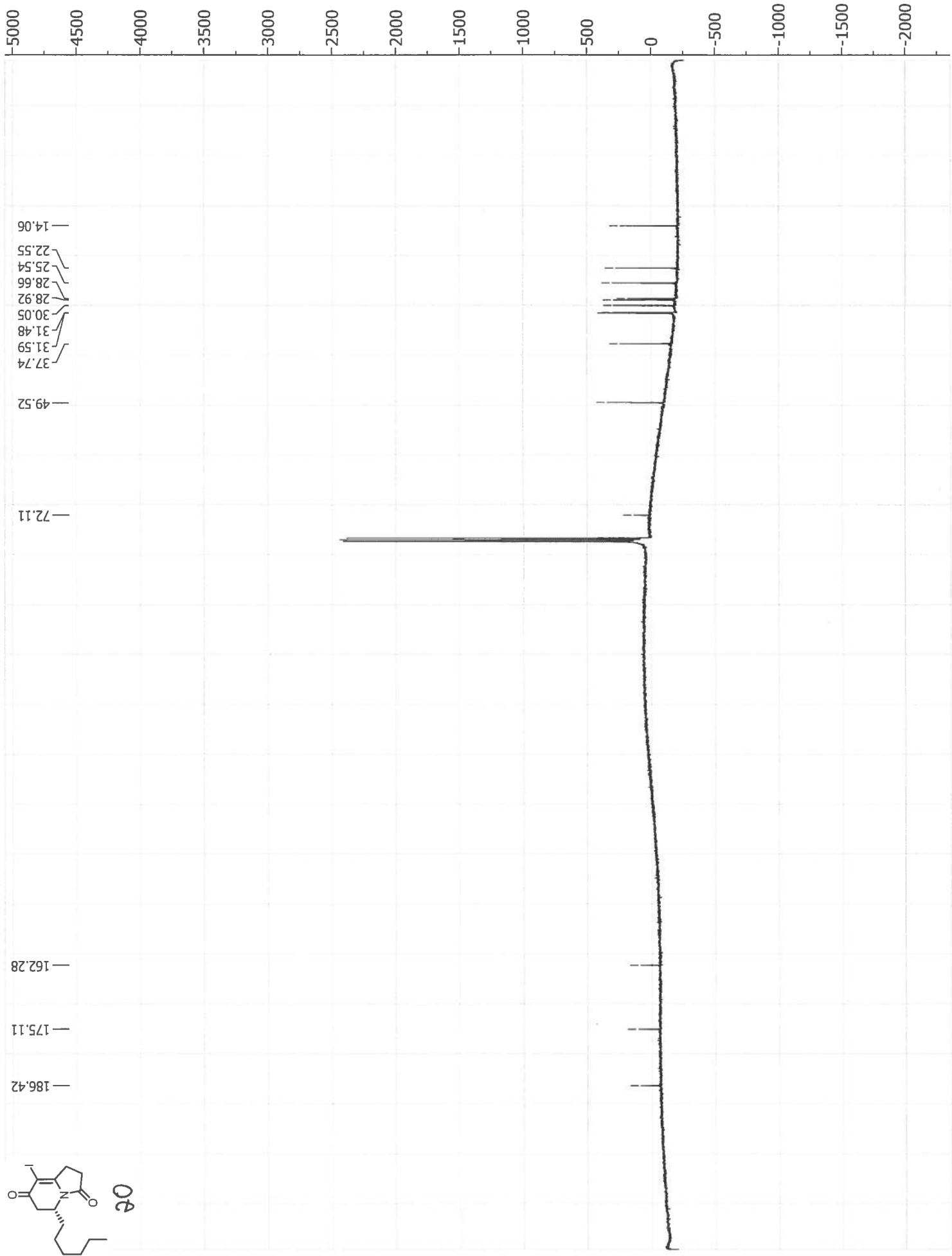

WV-10-vc-82.3.fid

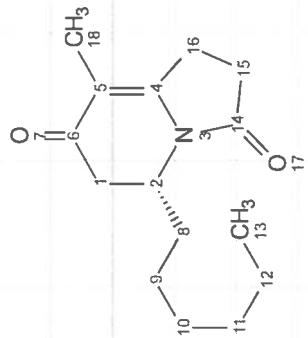

1e

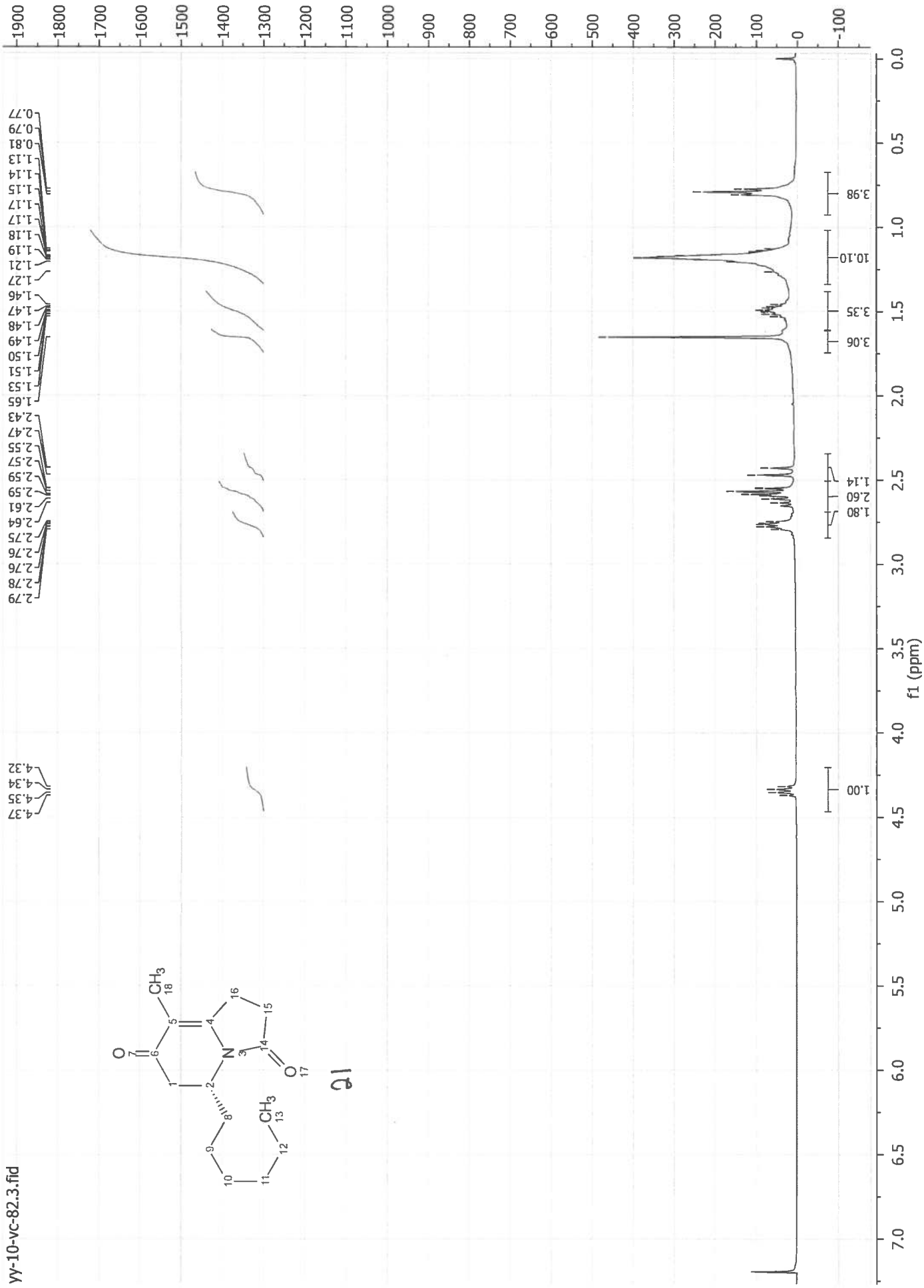

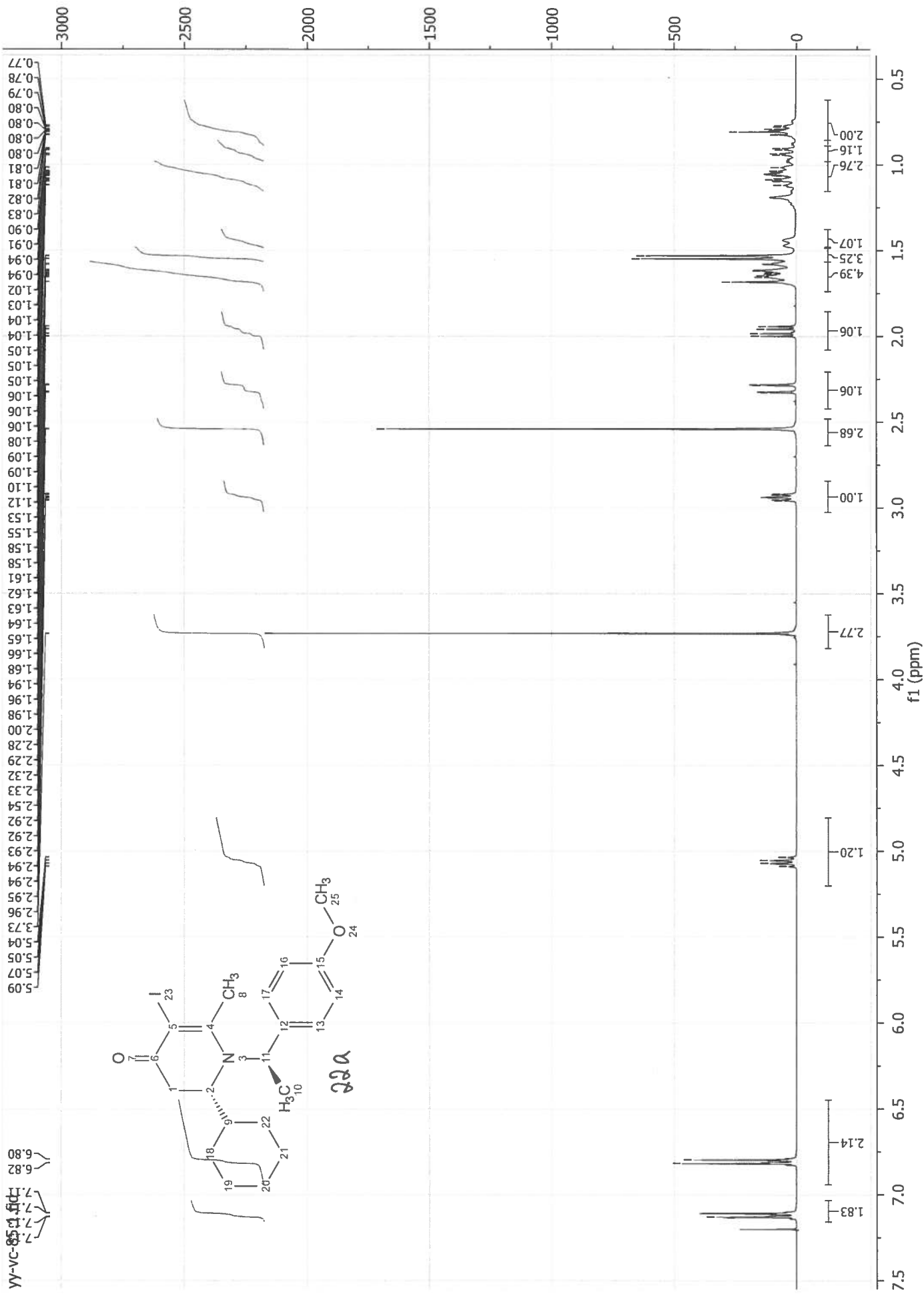

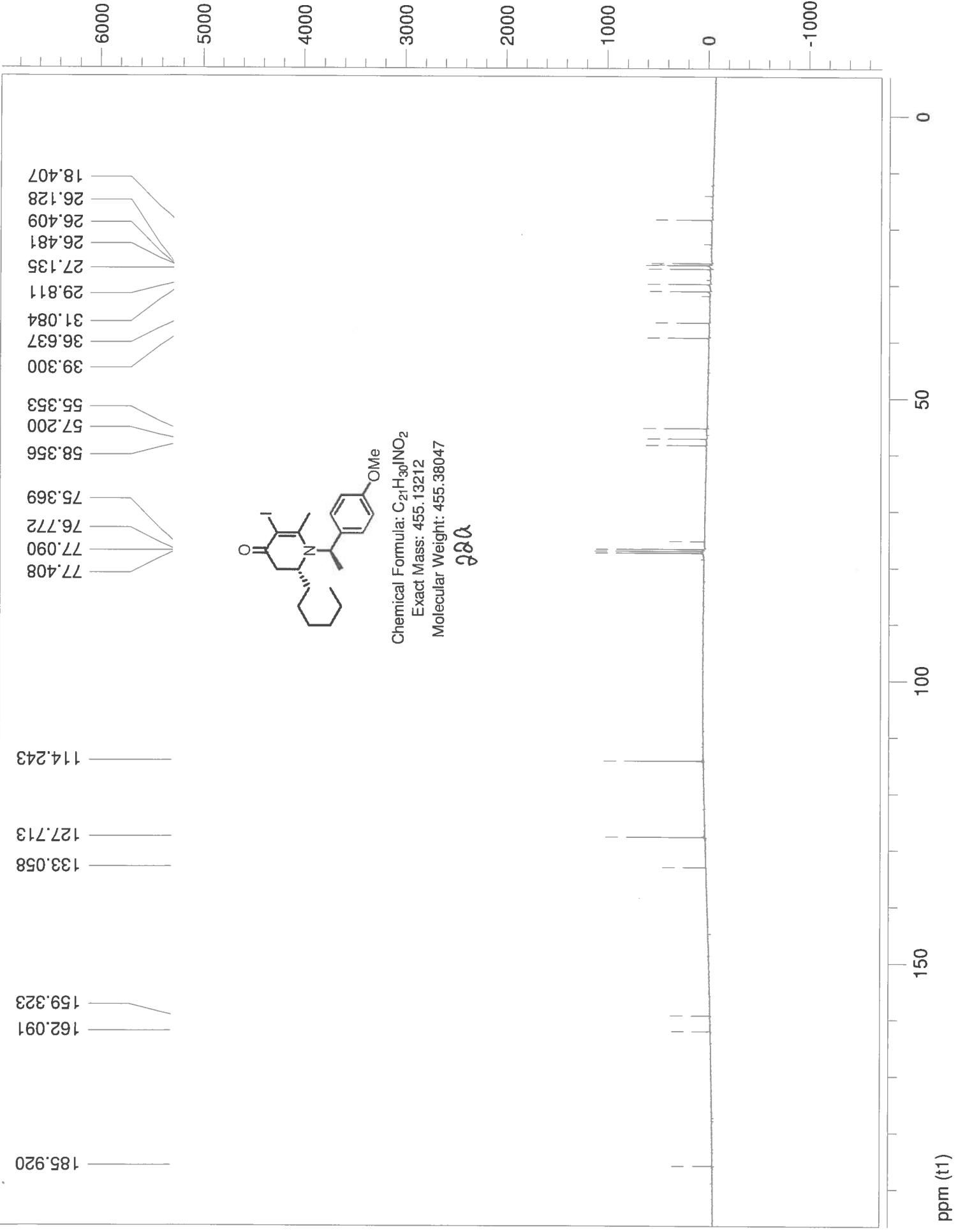

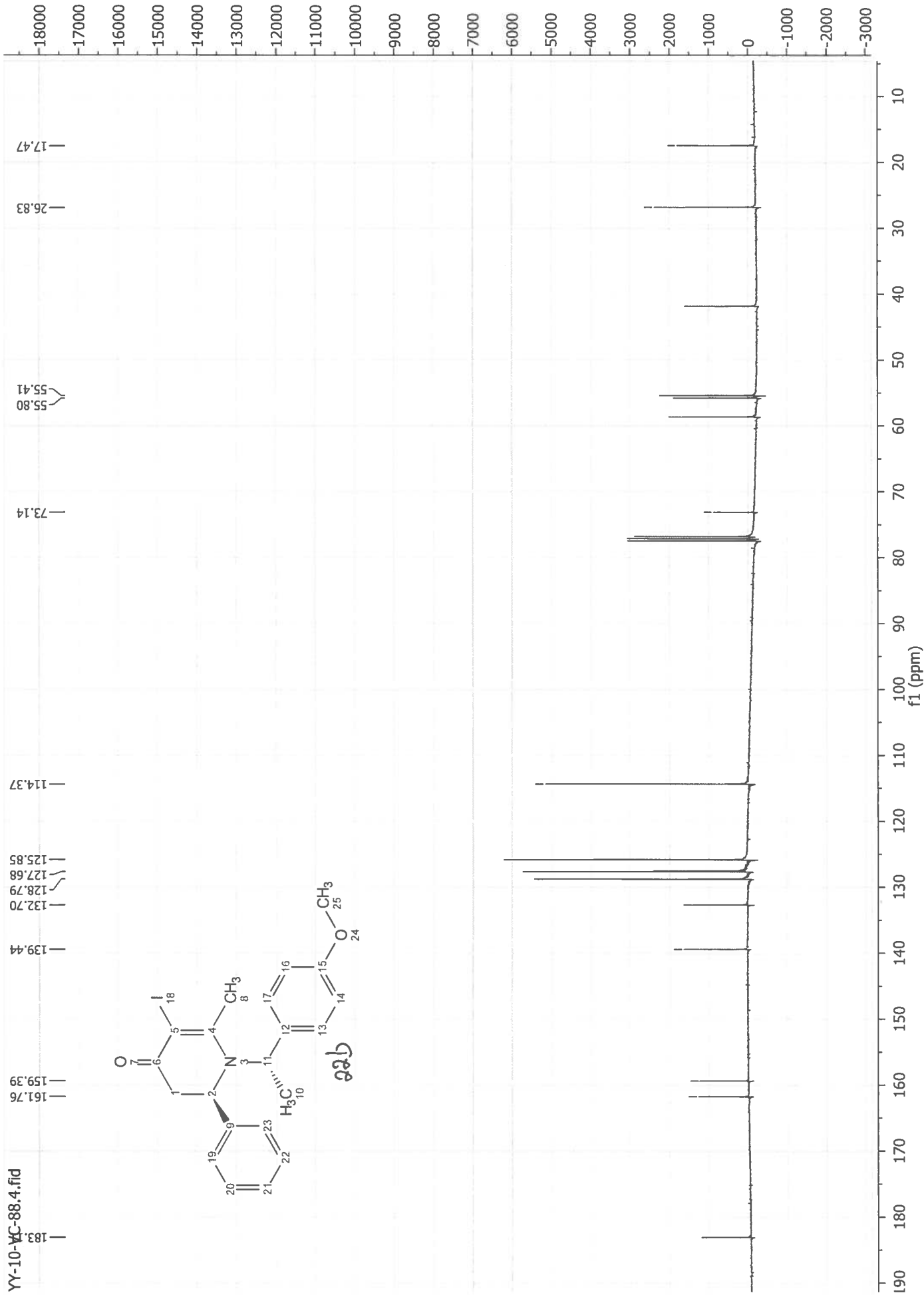

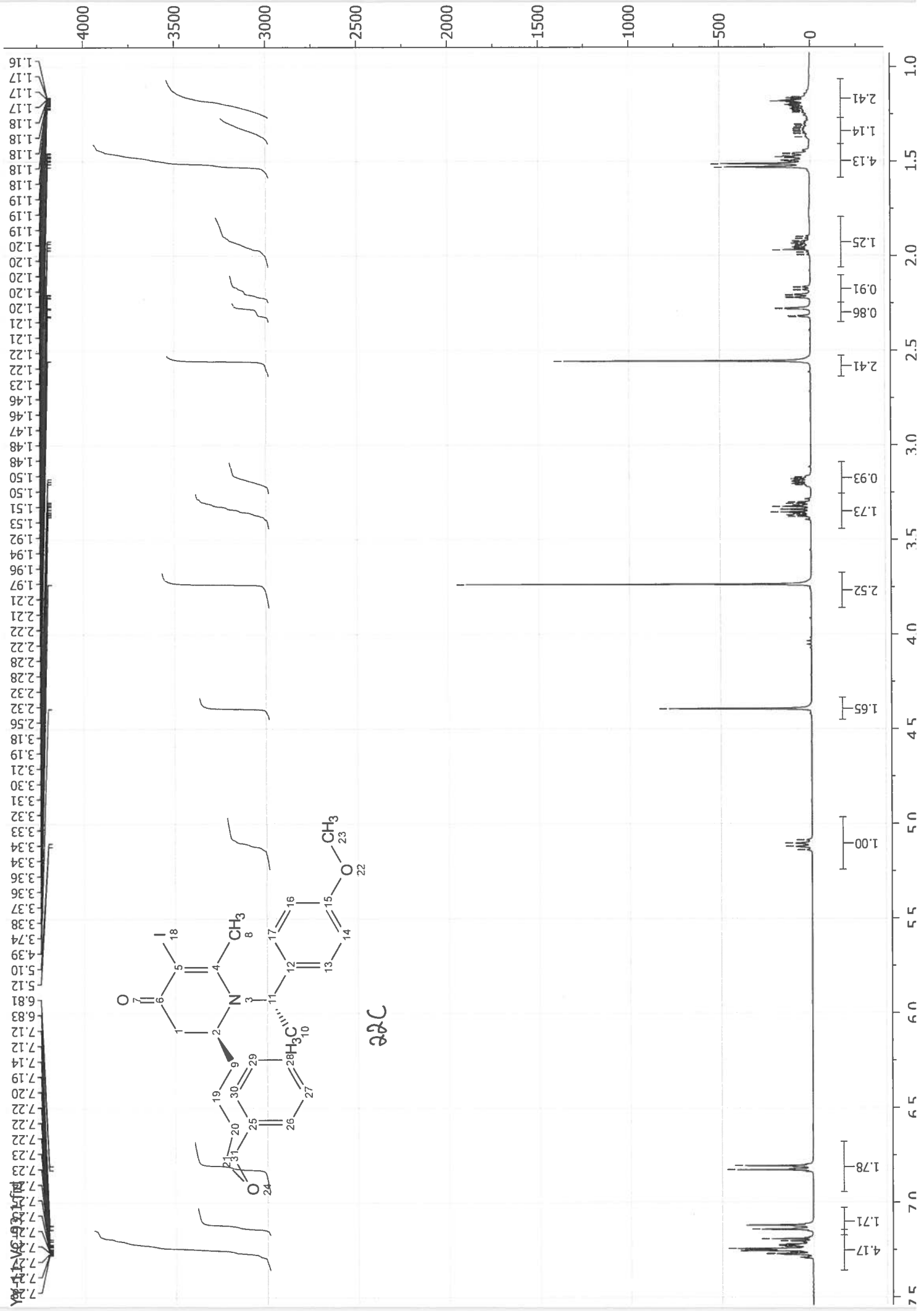

22C

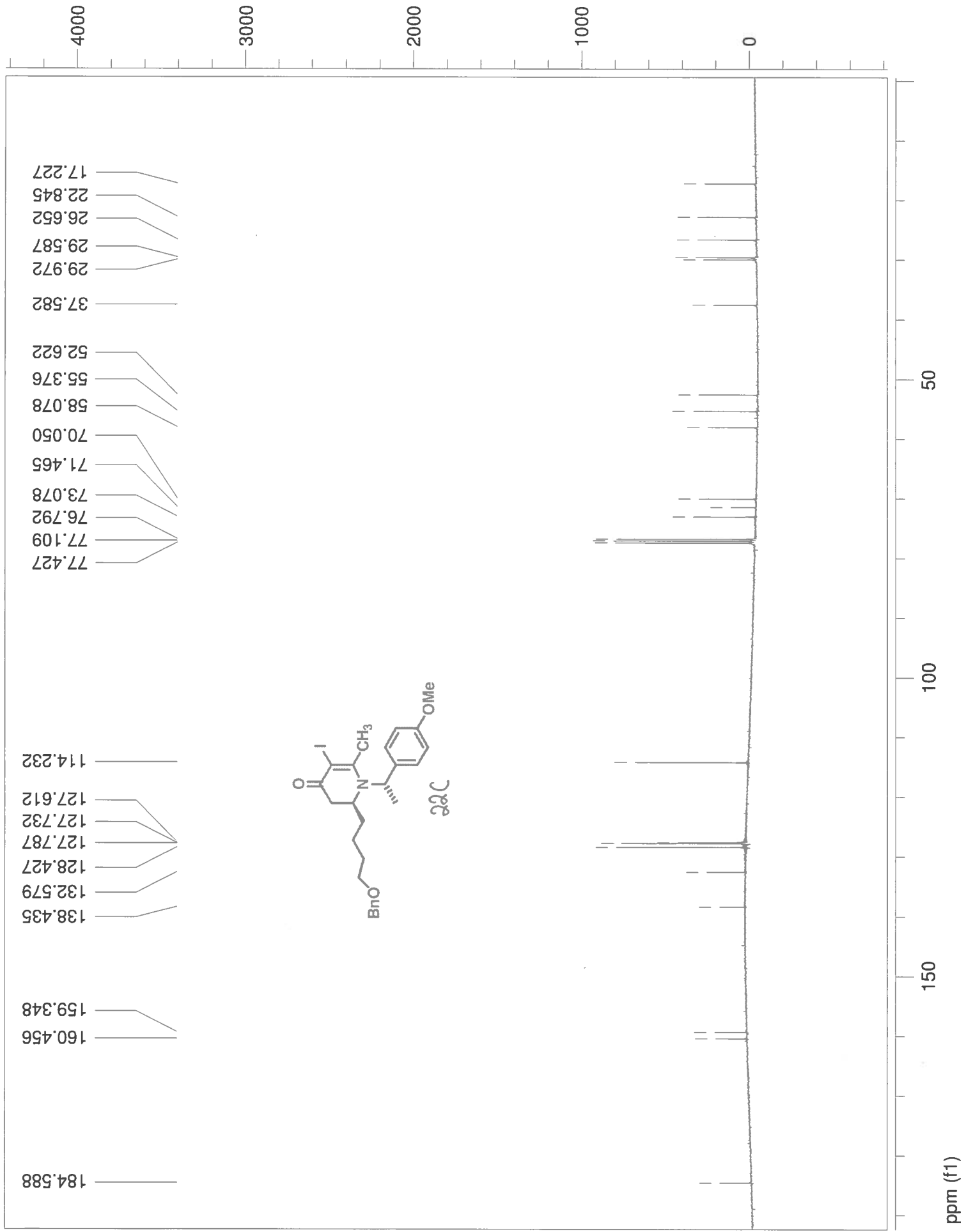

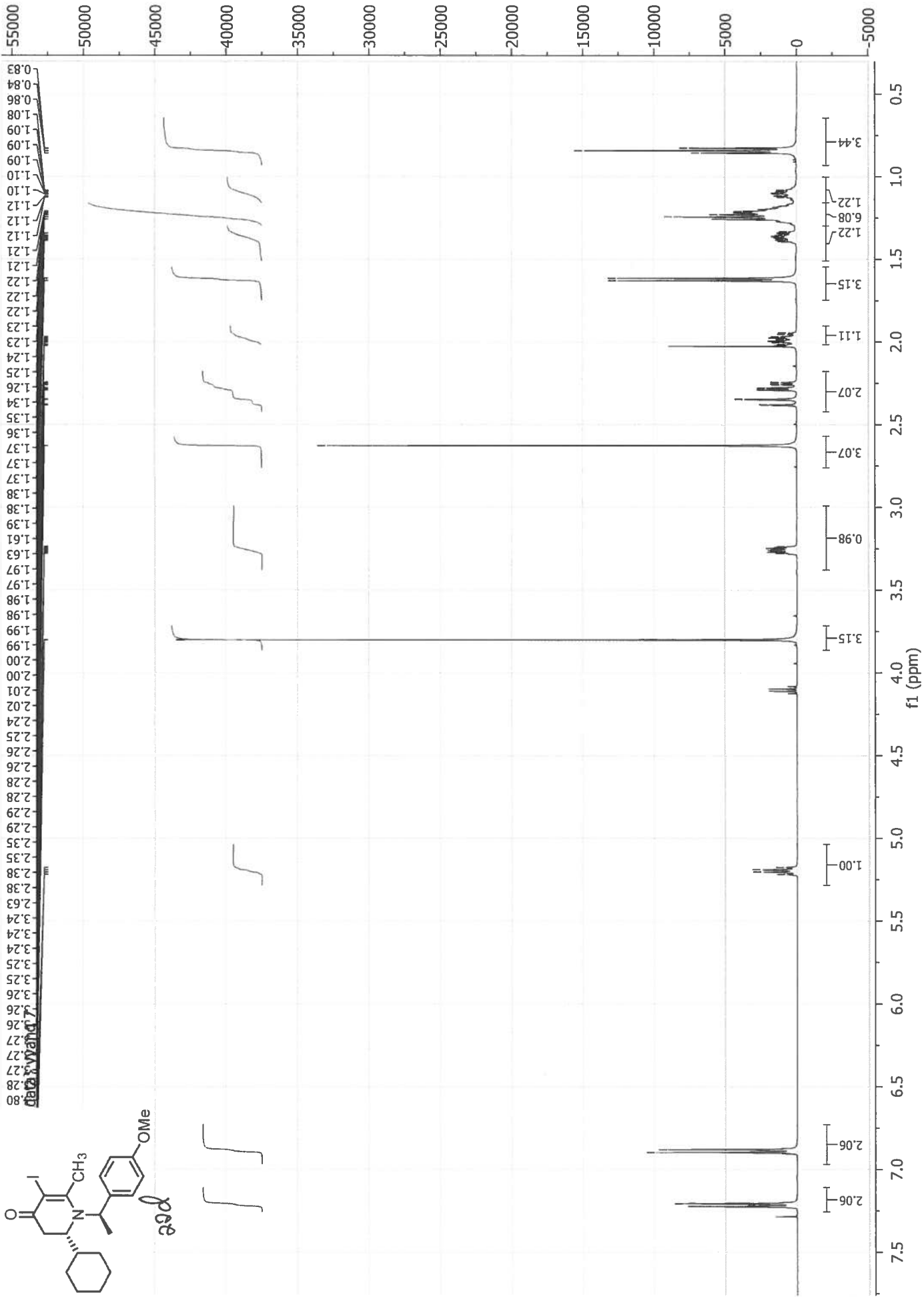

0.83
0.84
0.86
1.08
1.09
1.09
1.10
1.10
1.12
1.12
1.12
1.21
1.21
1.22
1.22
1.22
1.23
1.23
1.24
1.25
1.26
1.34
1.35
1.36
1.37
1.37
1.37
1.38
1.39
1.61
1.63
1.97
1.97
1.98
1.98
1.99
2.00
2.00
2.01
2.02
2.24
2.25
2.26
2.26
2.28
2.28
2.29
2.29
2.35
2.35
2.38
2.38
2.63
3.24
3.24
3.24
3.25
3.25
3.26
3.26
3.26
3.27
3.27
3.28
3.28
3.80

0.5
1.0
1.5
2.0
2.5
3.0
3.5
4.0
4.5
5.0
5.5
6.0
6.5
7.0
7.5

f1 (ppm)

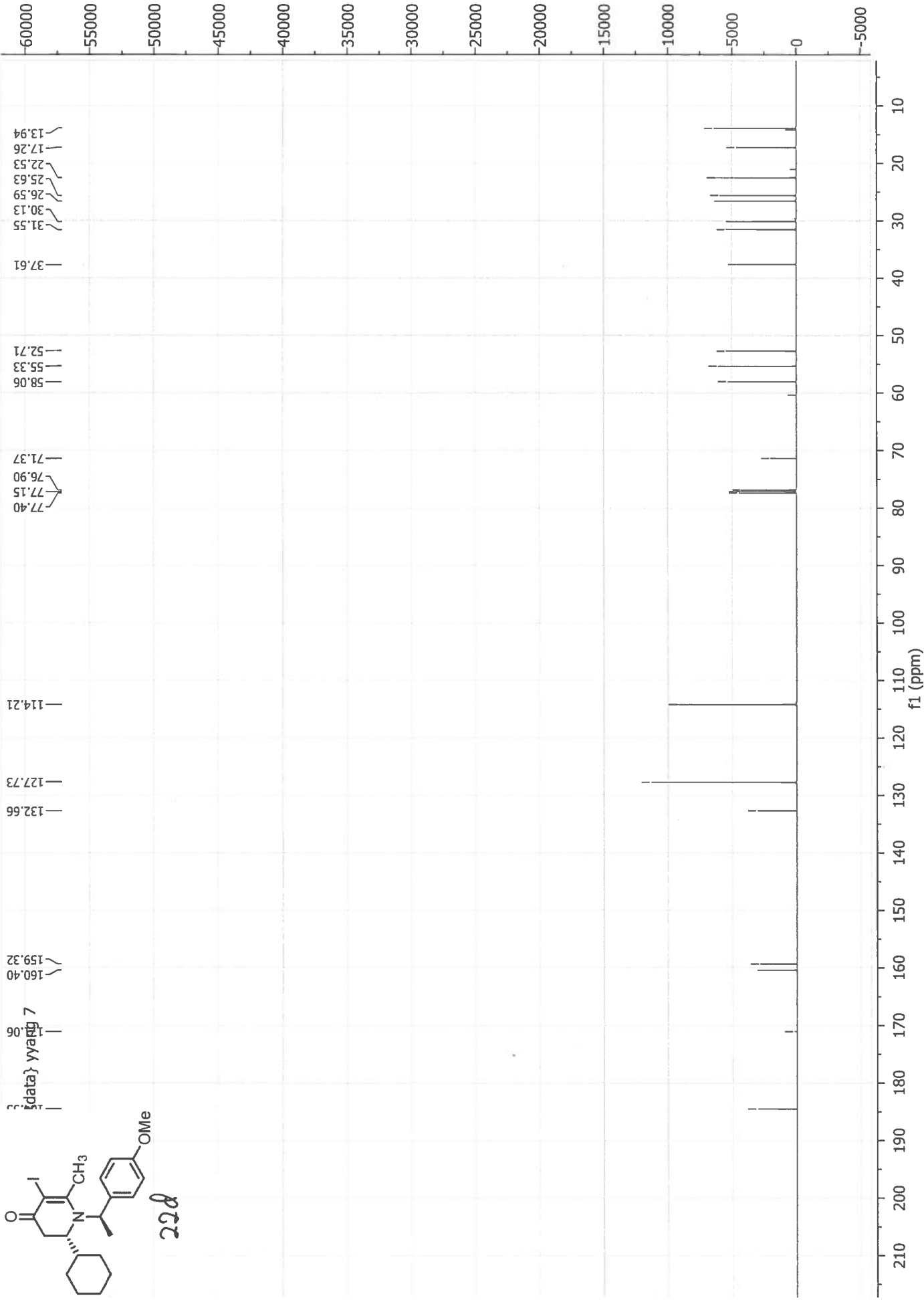

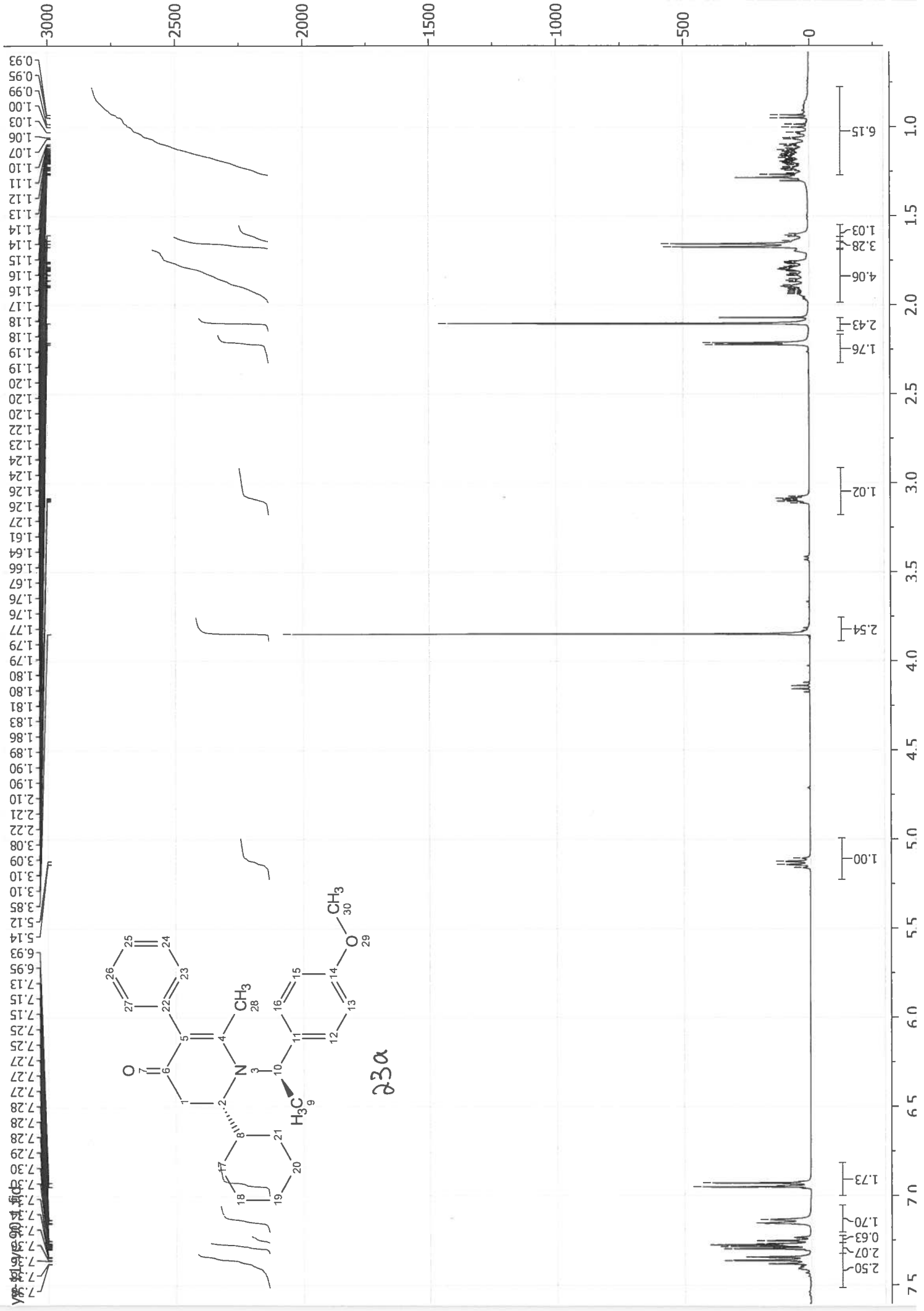

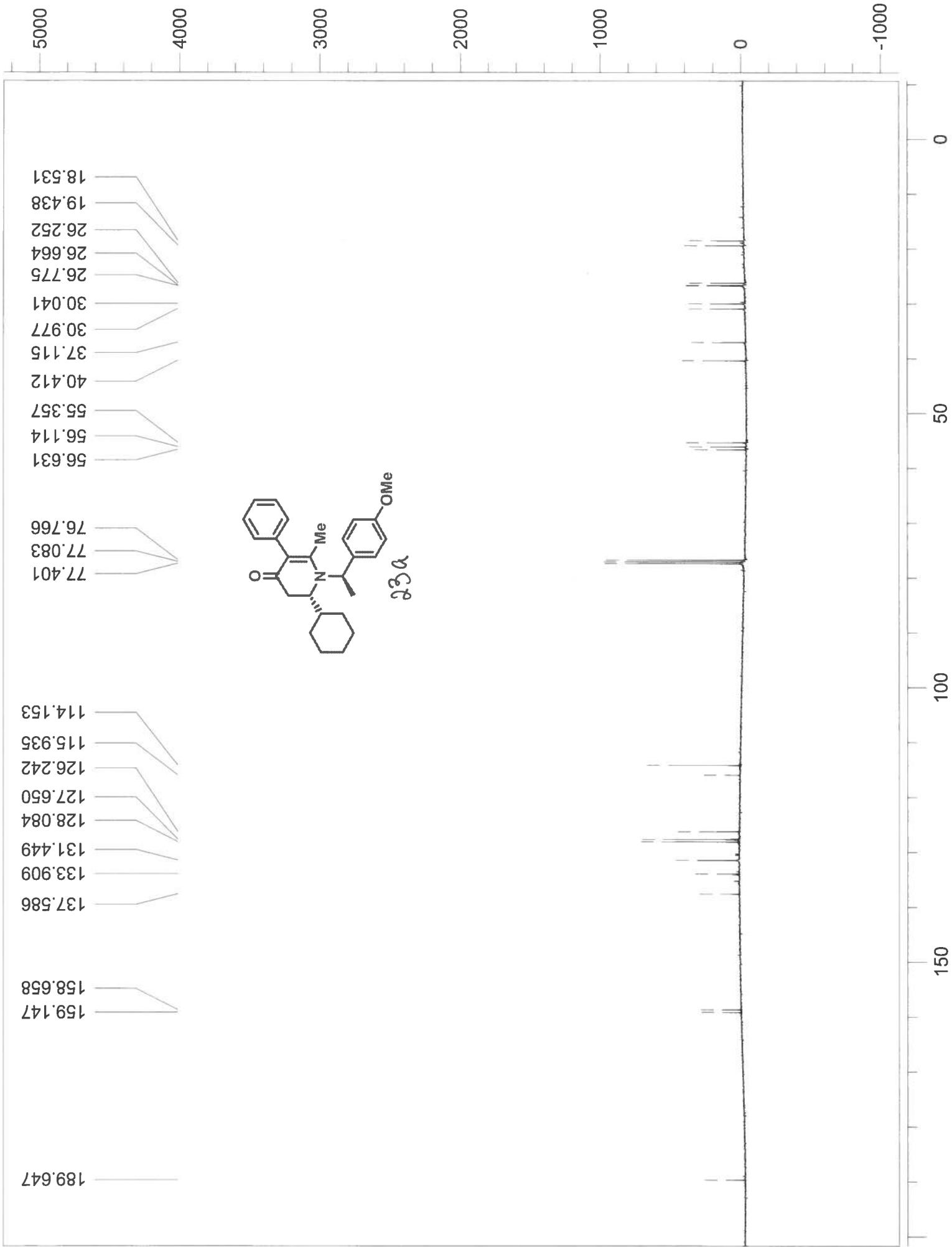
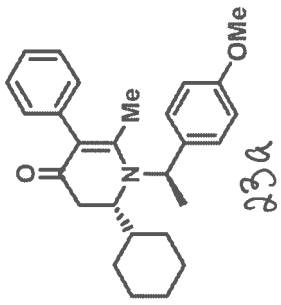

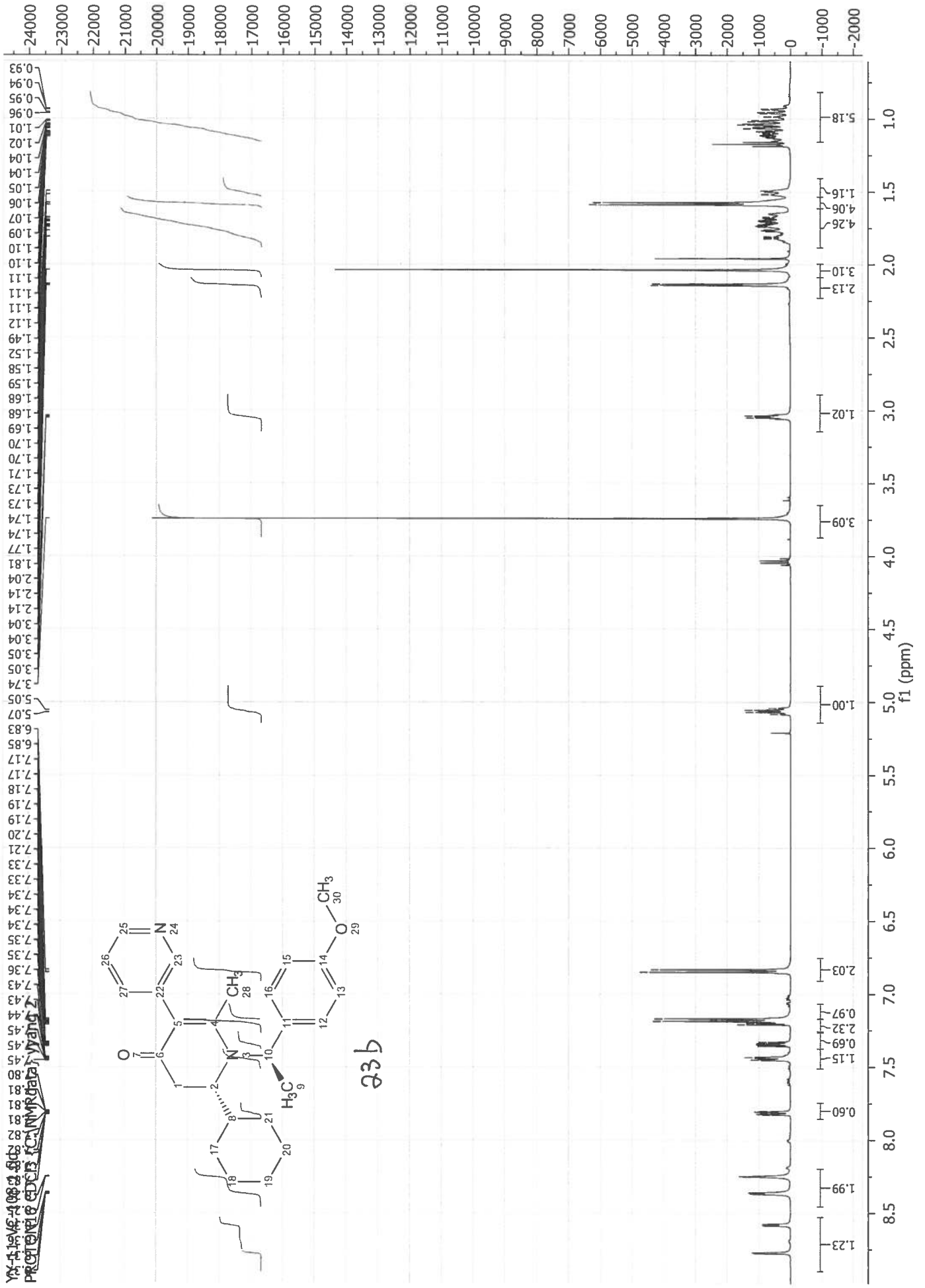

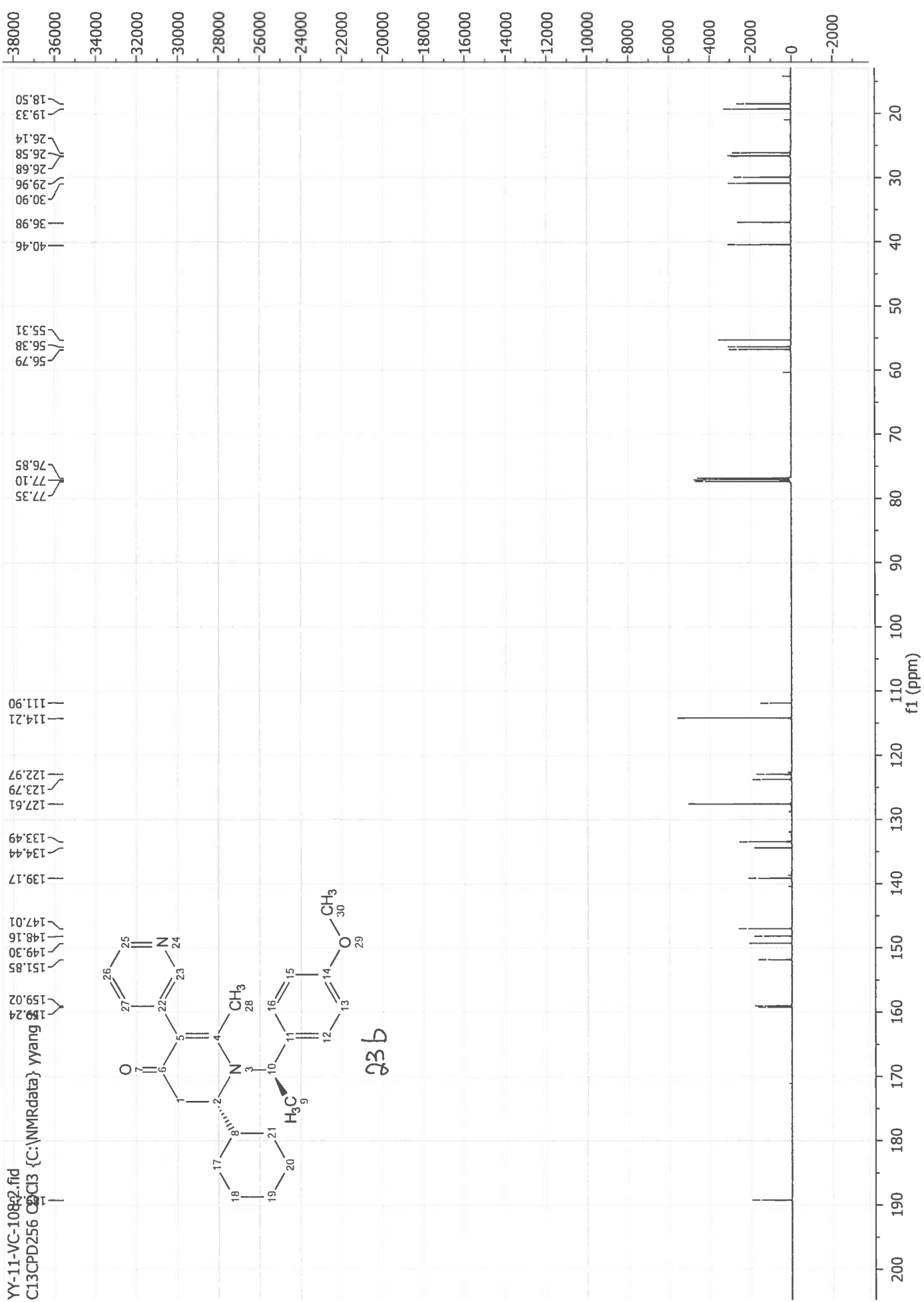

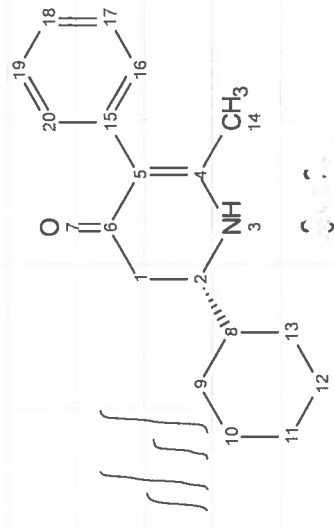

24a

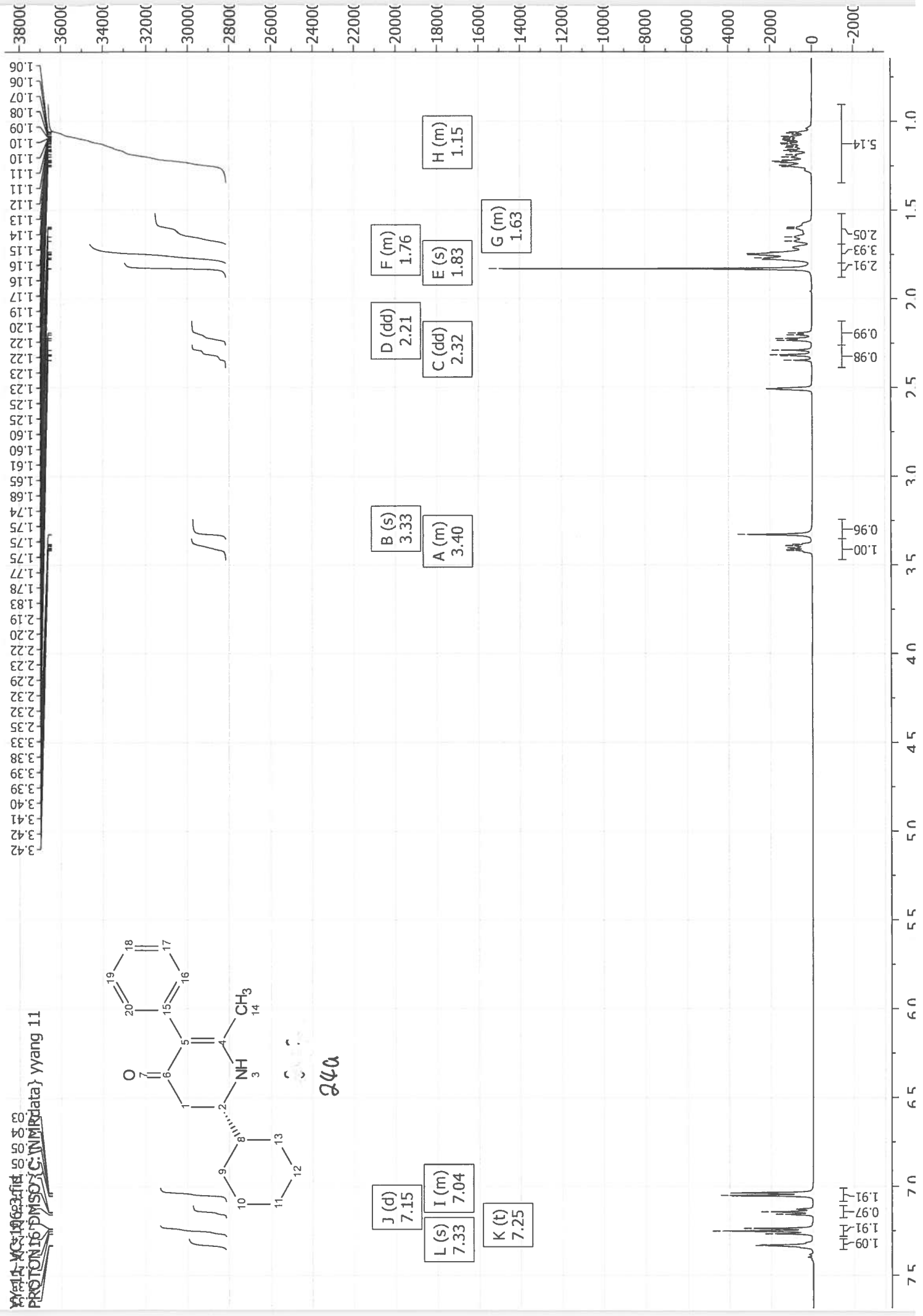

YY-11-VC-106.4.fid
C13CPD256 DMSO {C13NMRdata} yyang 1115

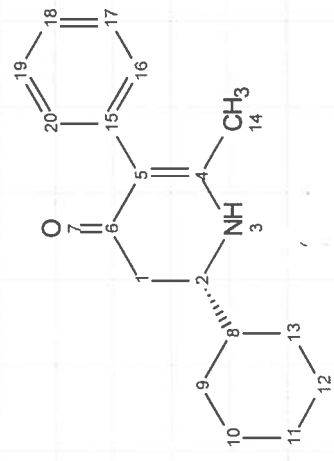

24a

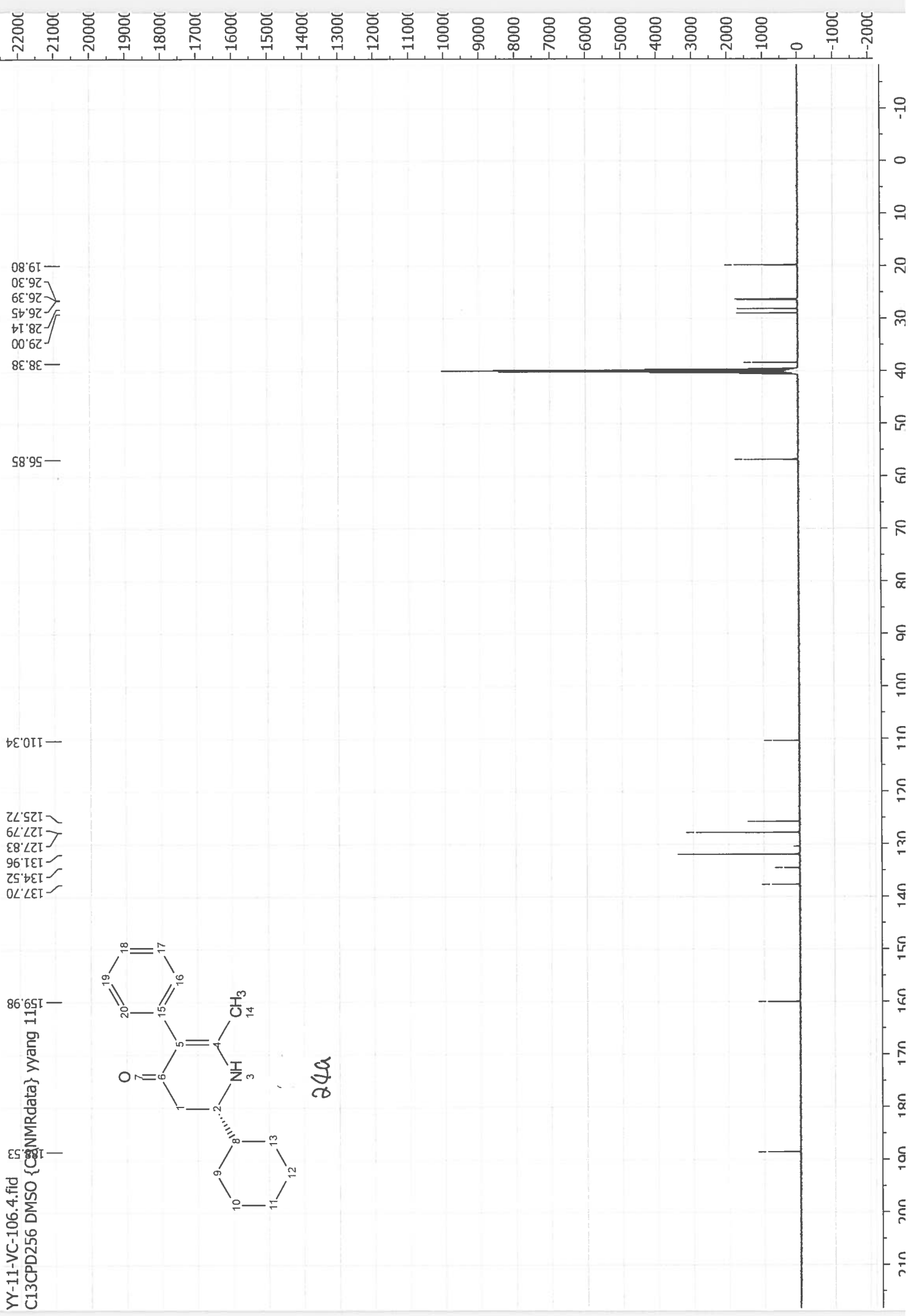

YY-114VC-110.2.fid
C13CPD256 CDCl3 {c:\NMRdata} 7/2/2017

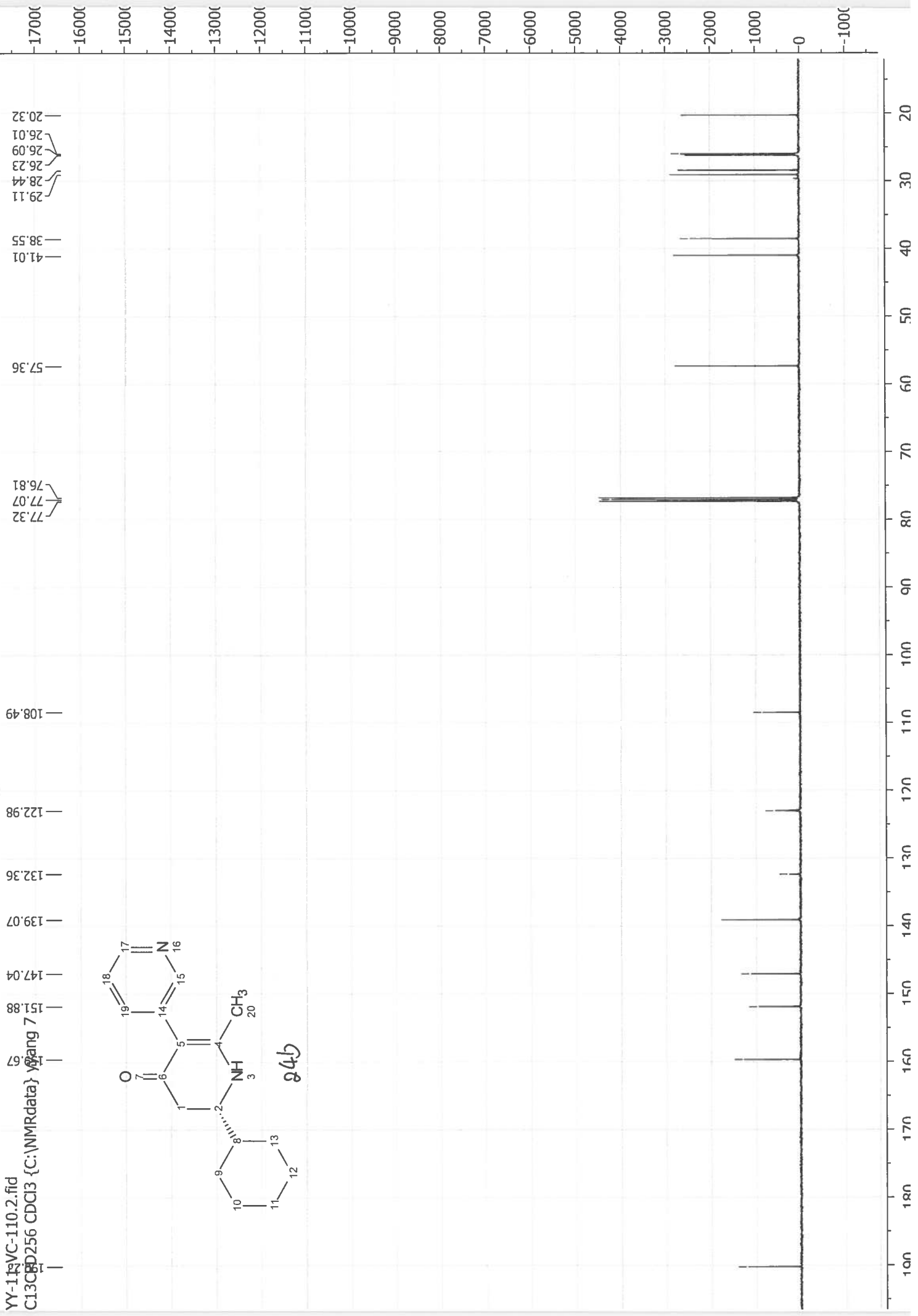
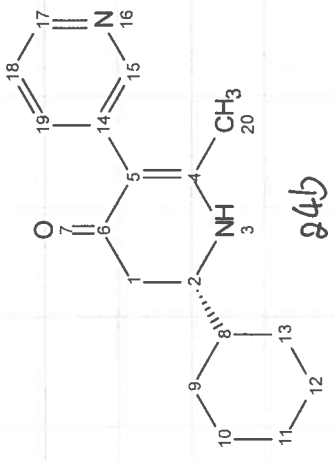

YAG-114AC-14 100% Me₂SO-d₆ 400 MHz, 300 K, INMRADETA Vyvanti 7
PR010116 CDE13 1C, INMRADETA Vyvanti 7

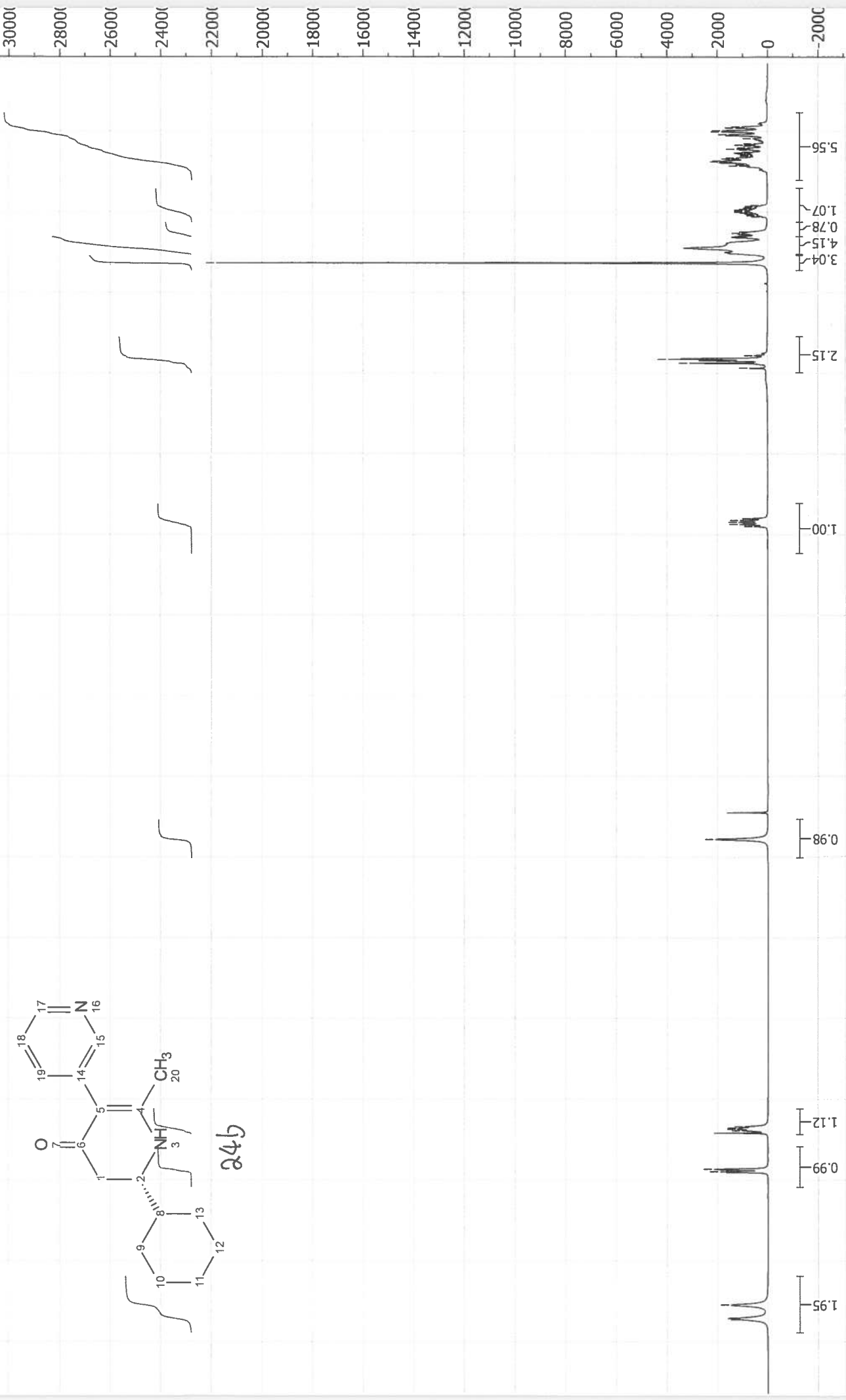

24b

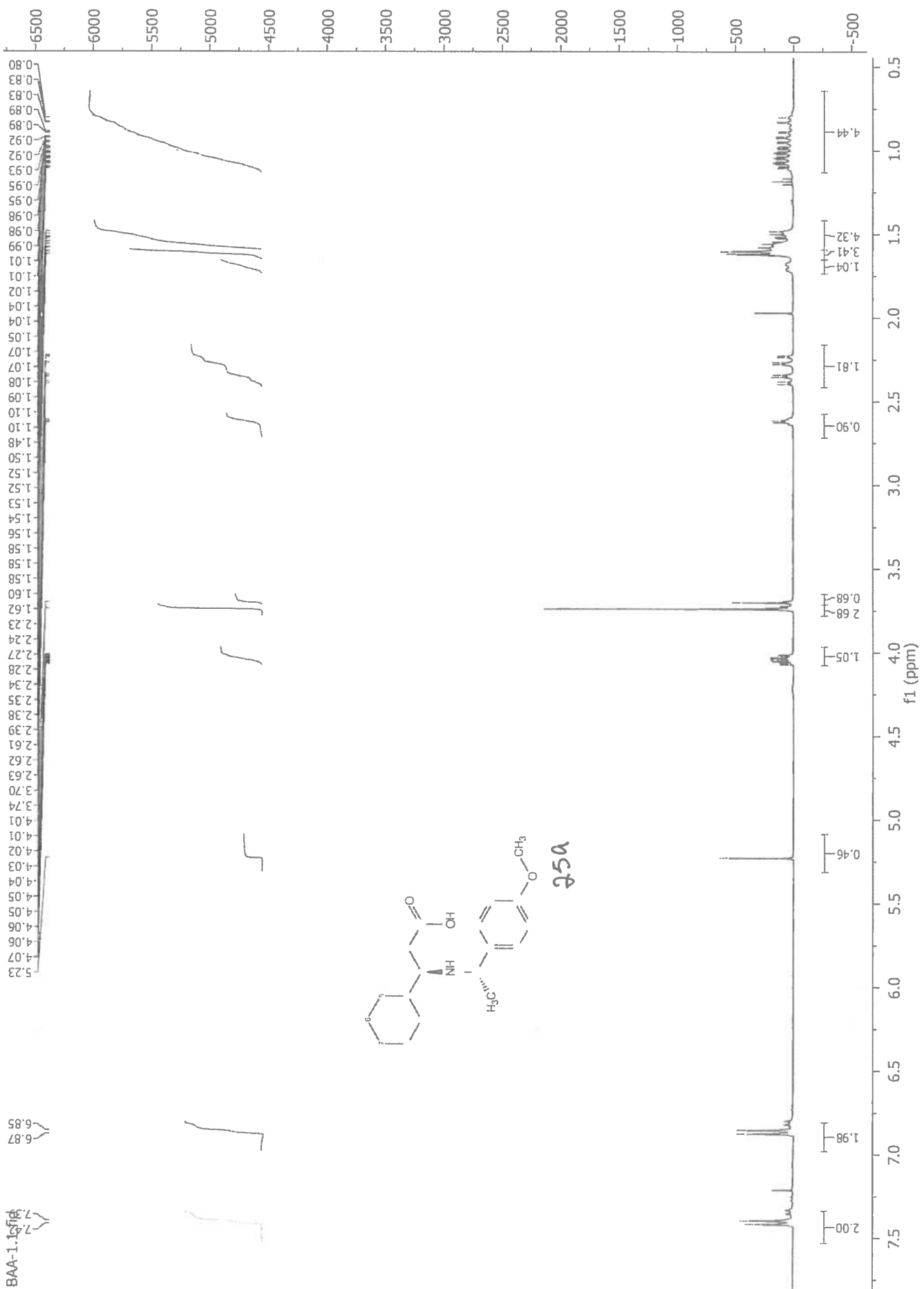

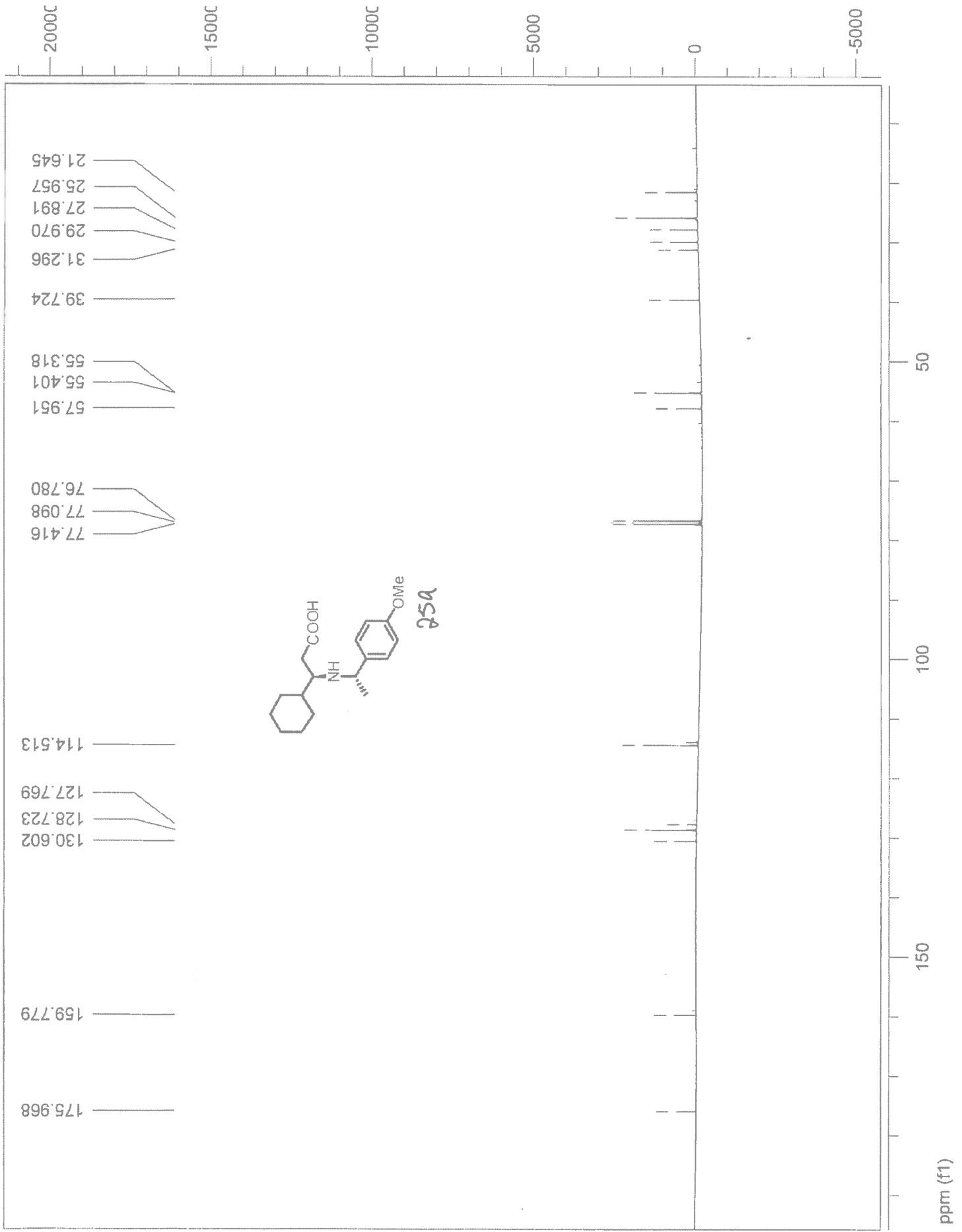

0731-hexBETA 4.fid
hexenal vmr cleave

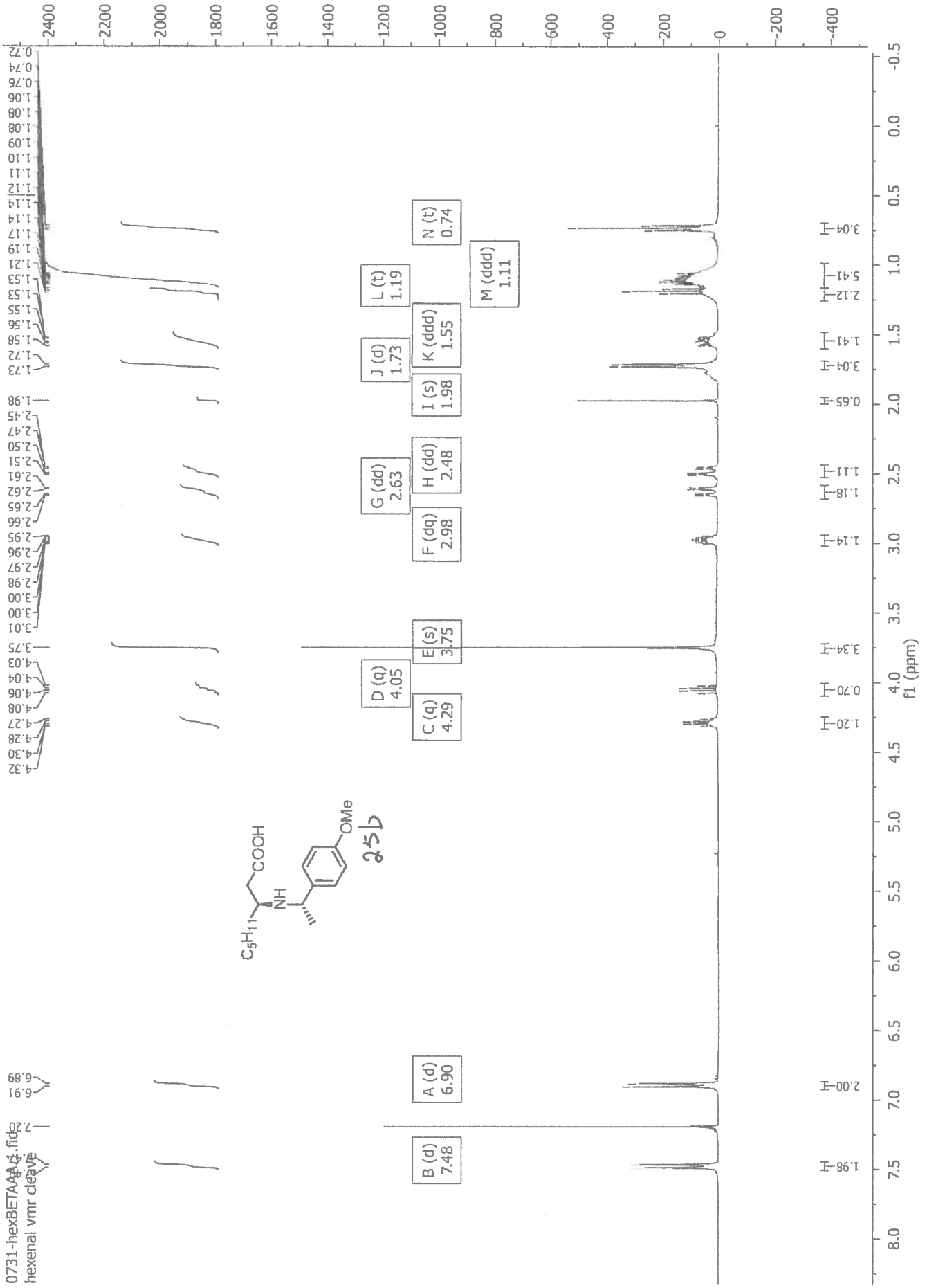
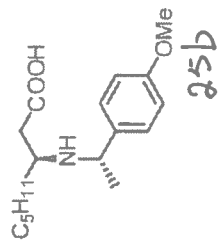

5948-0701-hexVMRcleave.2.fid
hexenol VMR cleaved

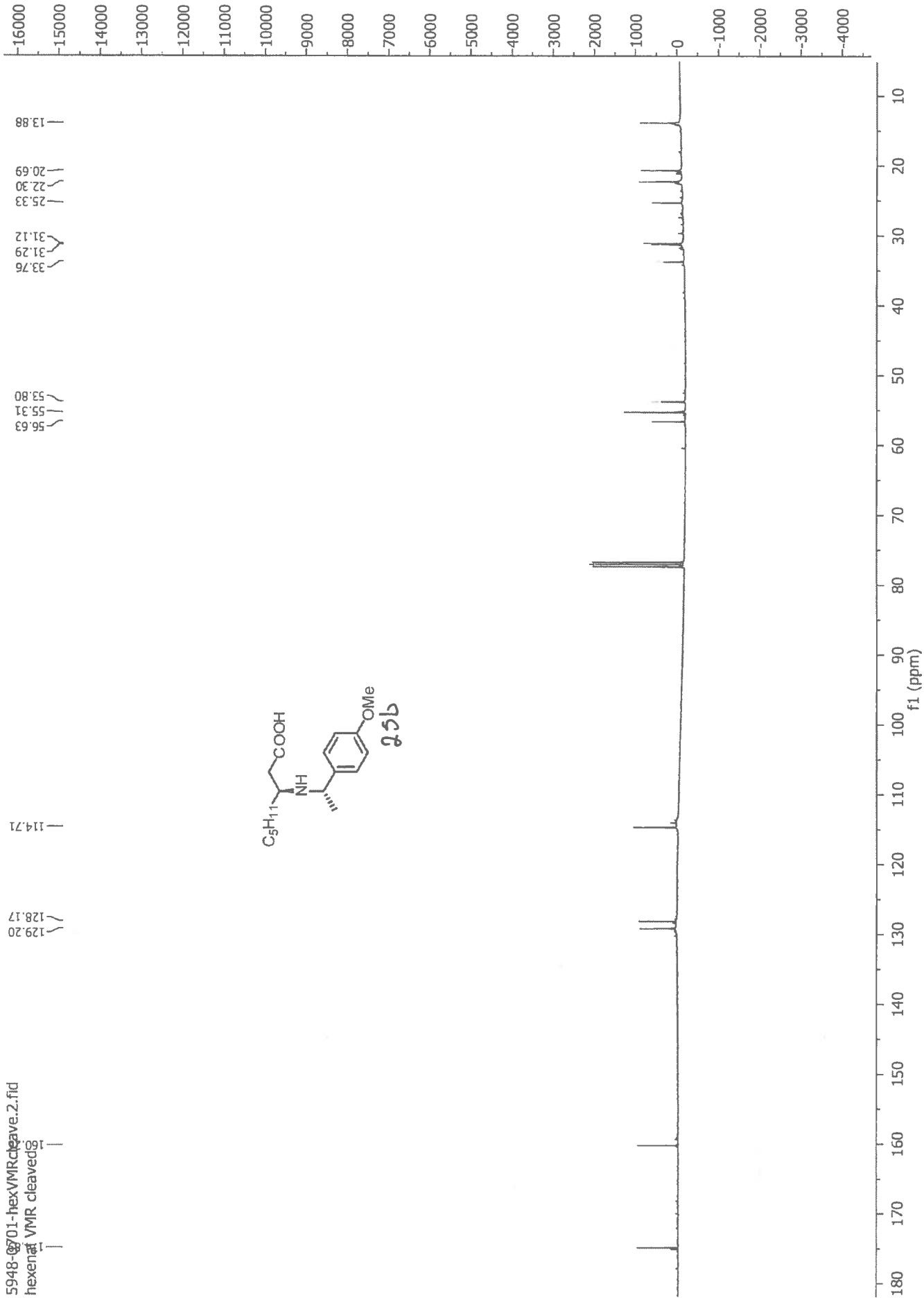

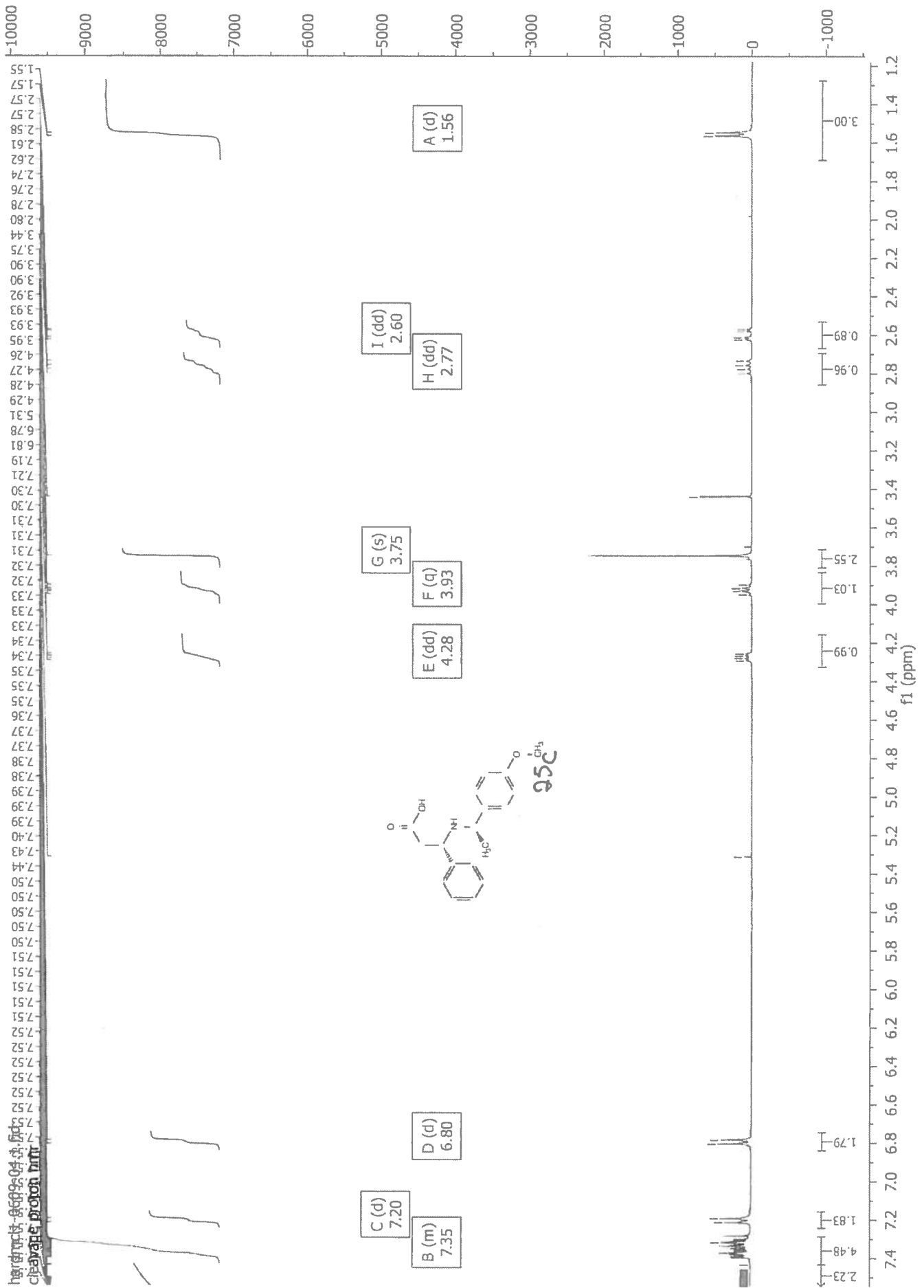

phe cleave dry2.fid
 PROTON30-Cryp CDCl3 E:\ chardman 9

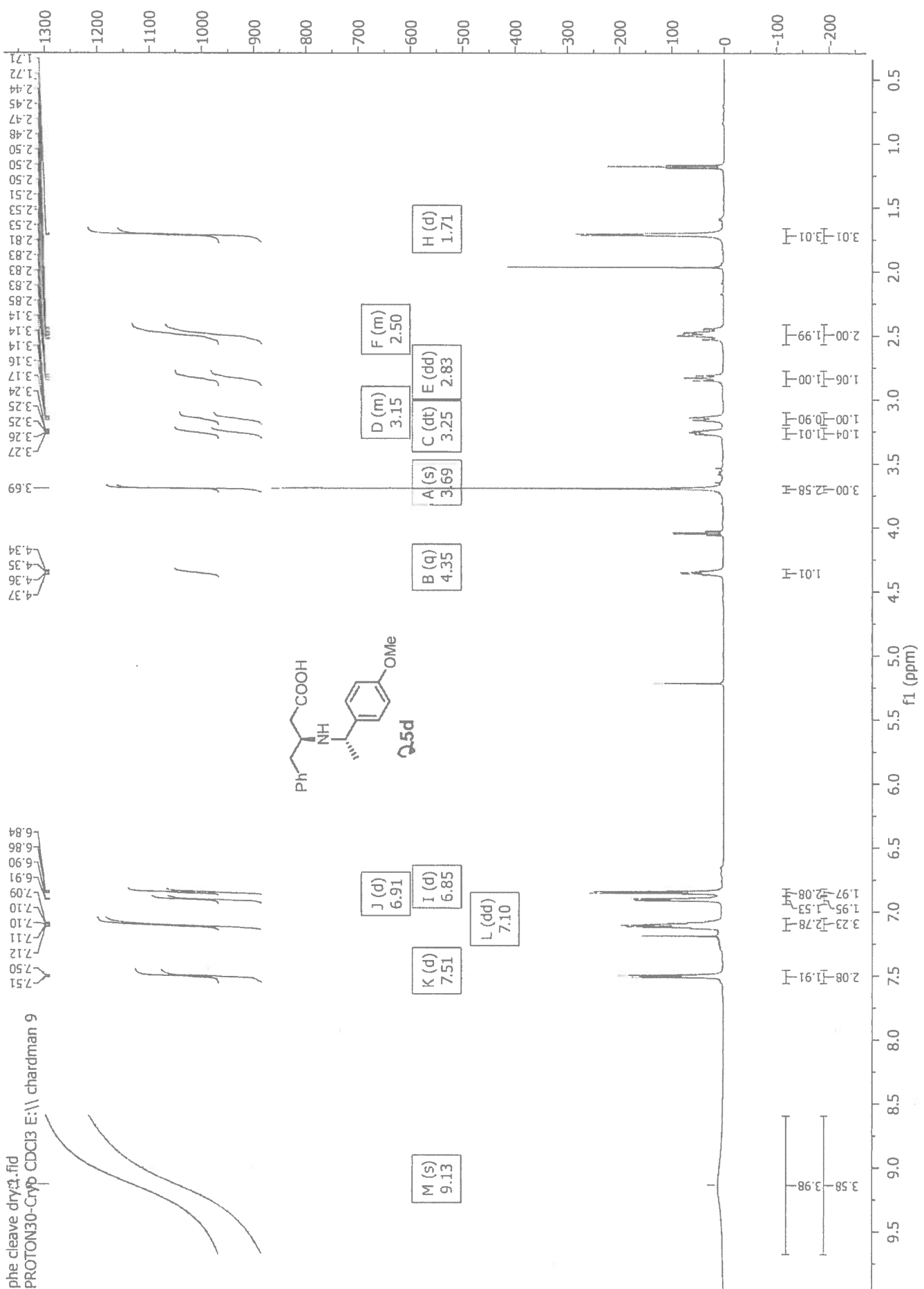

phe_gleave dry.3.fid
Carbon_TCI CDCl3.d1 chardman 9

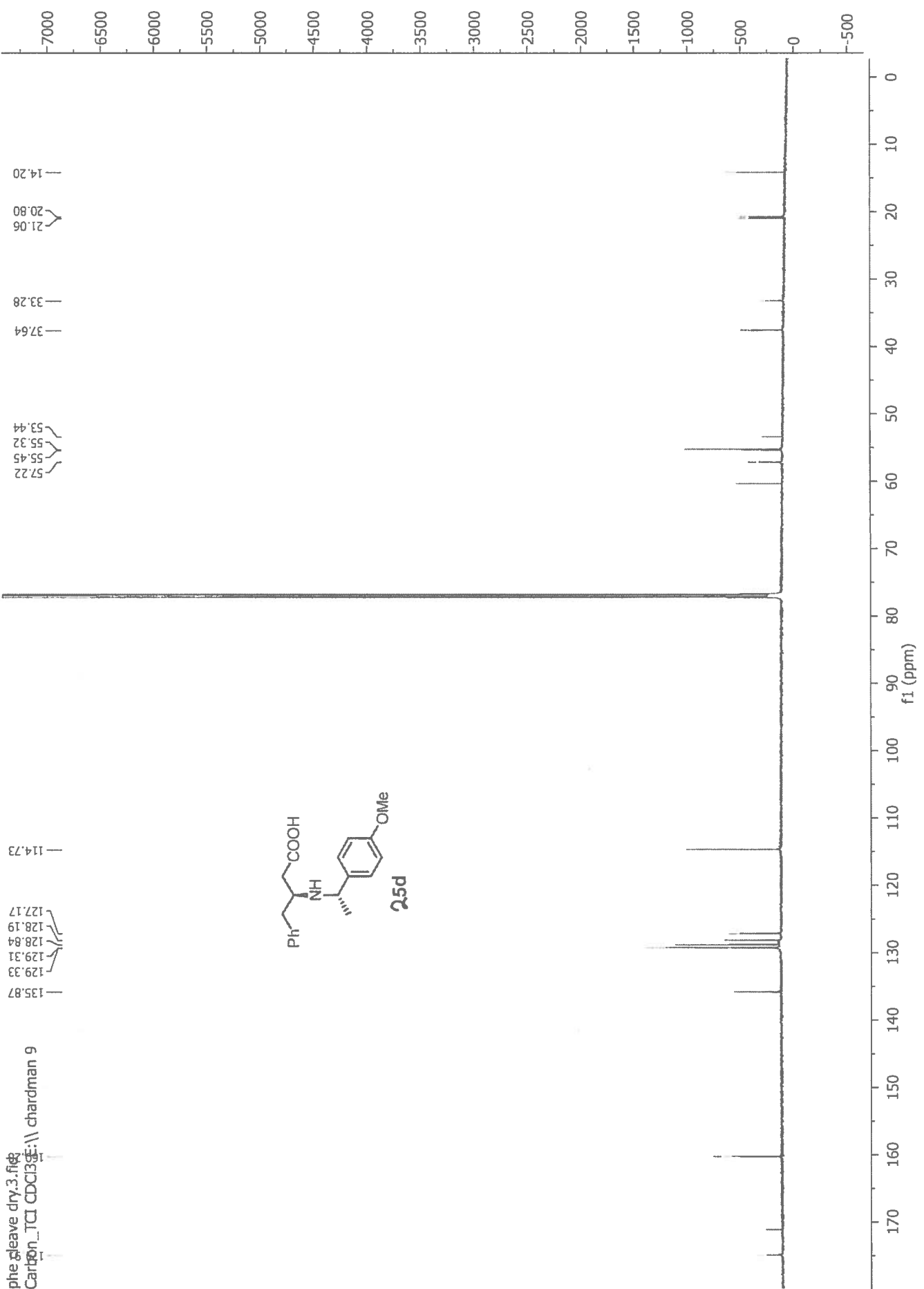

cbz-N-riptide AA chx (8888).fid
 cbz-N-riptide AA g
 PROTON30-Cryo CDC13 E:\\ chardman 16

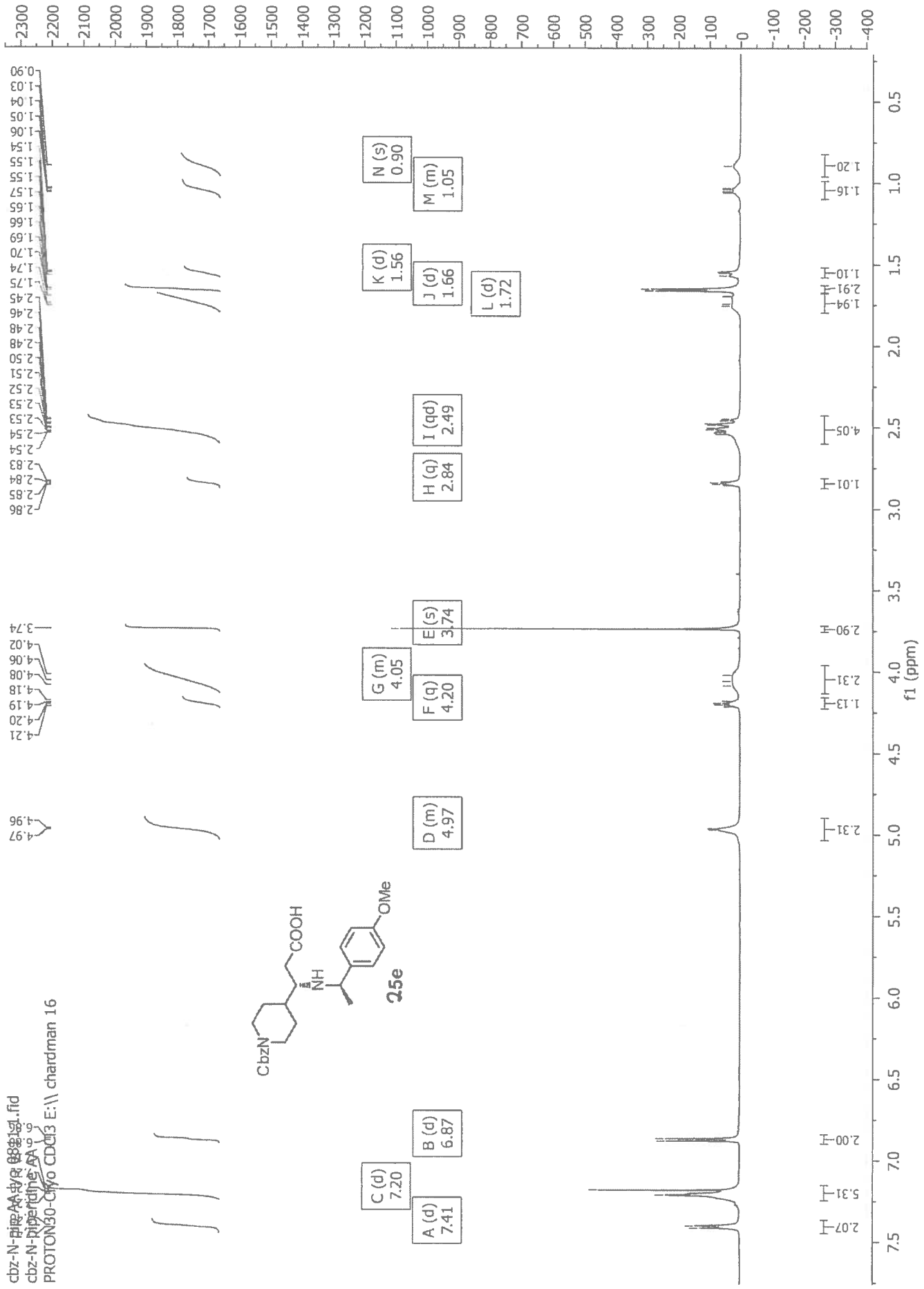
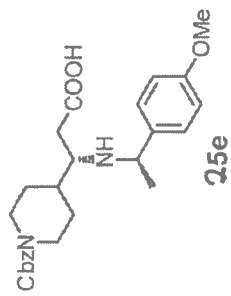

cbz-N-~~pp~~ AA lyo 081 12. f16
cbz-N-~~pp~~iperidine AA
CARBON_TCI_1024 CDCl3 F:\ chardman 16

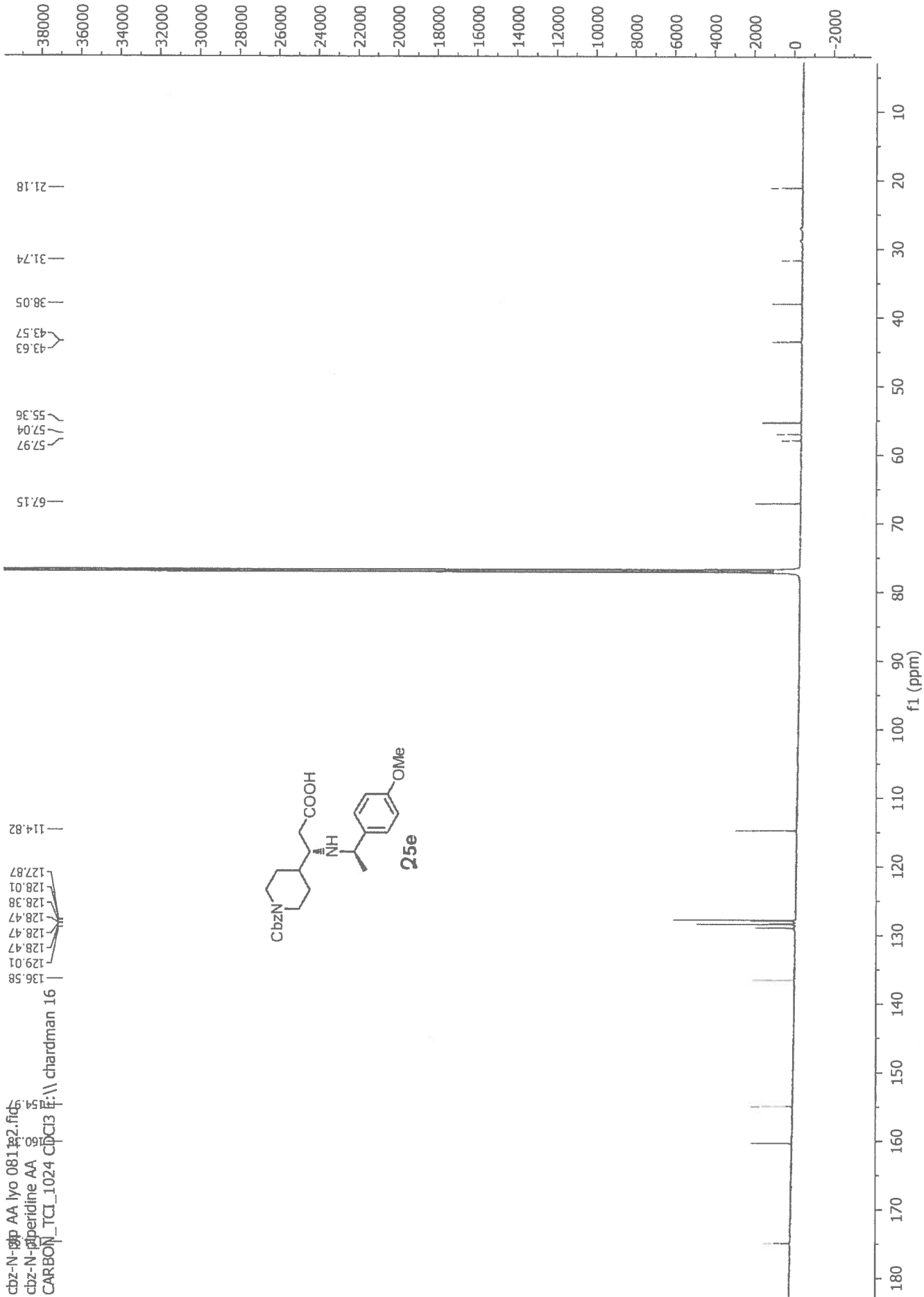
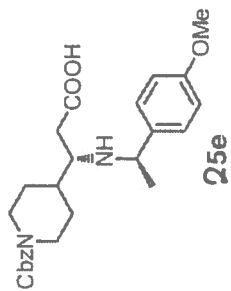

ethanol-d4
 ester amino acid
 PROTONS
 CDCl3 E: chardman 6

4.37
4.35
4.32
4.30
3.98
3.97
3.96
3.94
3.72
3.42
3.41
3.40
3.39
3.39
3.38
3.37
3.36
3.12
3.11
3.11
3.10
3.10
3.09
2.45
2.43
2.42
2.33
2.32
2.29
1.46
1.44

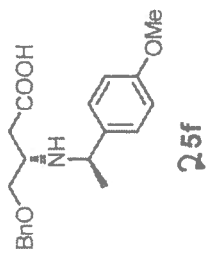

B (m) 7.20
A (d) 6.81

C (m) 4.35

D (q) 3.96

F (qd) 3.39

H (dd) 2.44

J (d) 1.45

G (td) 3.11

I (dd) 2.31

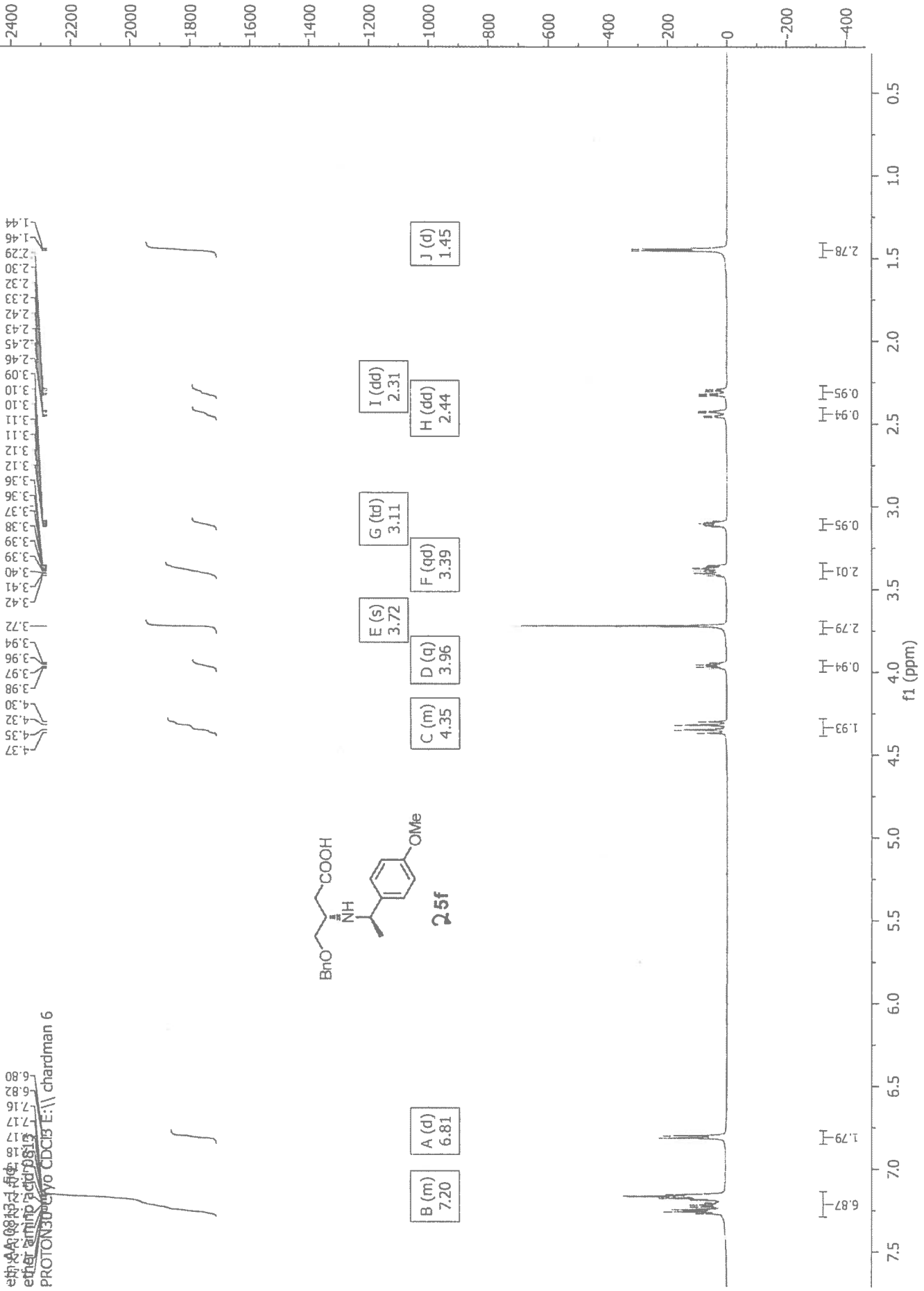

6.87
1.79

1.93
0.94
2.79
2.01
0.95

2.78

eth SA 0813.2.fid
ether amino acid 0813
CARBON_TCI_1024 CDCl3 E:\ chardman 6

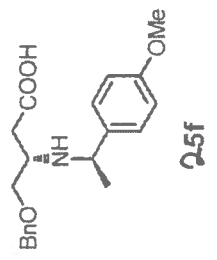
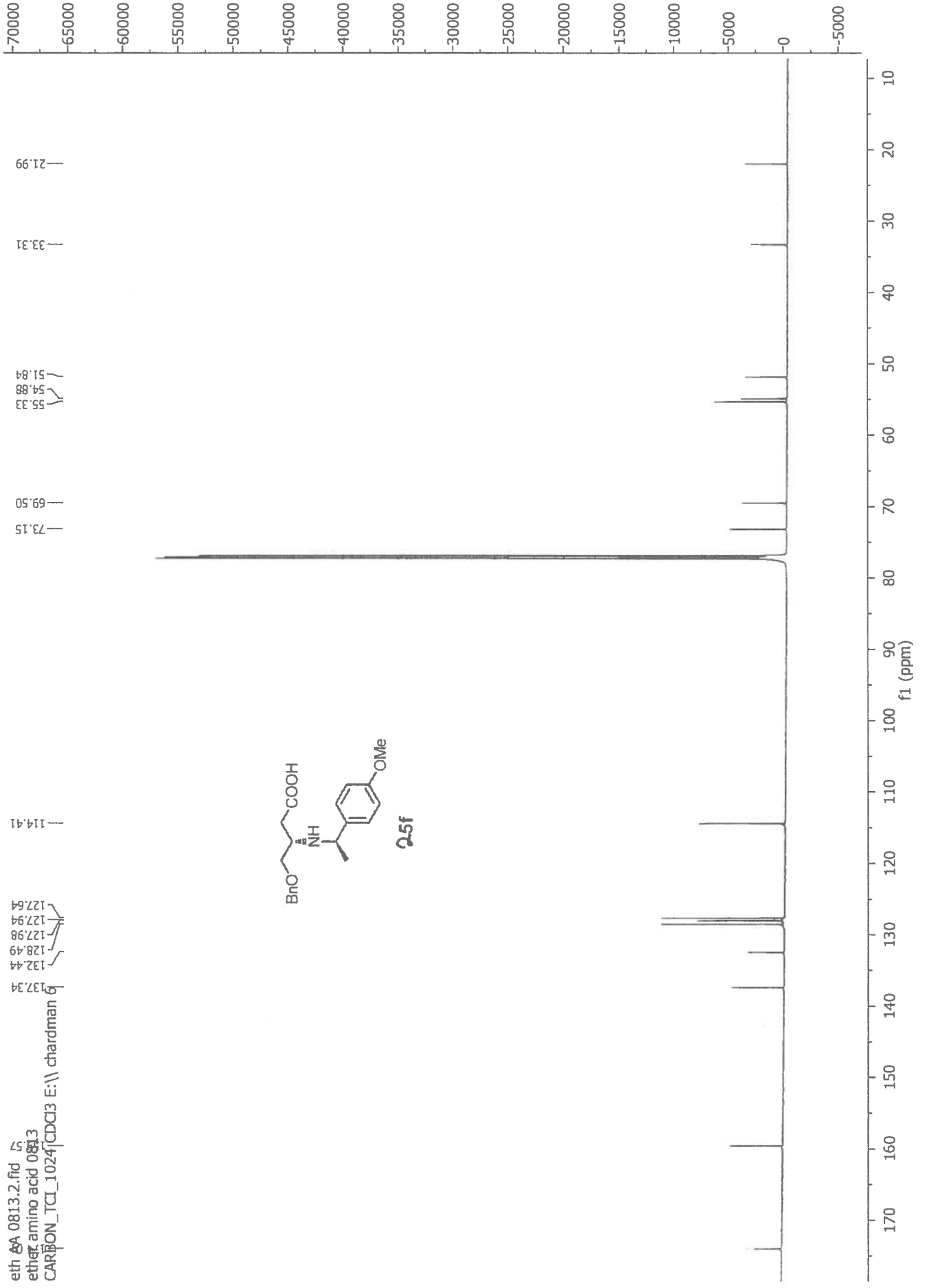

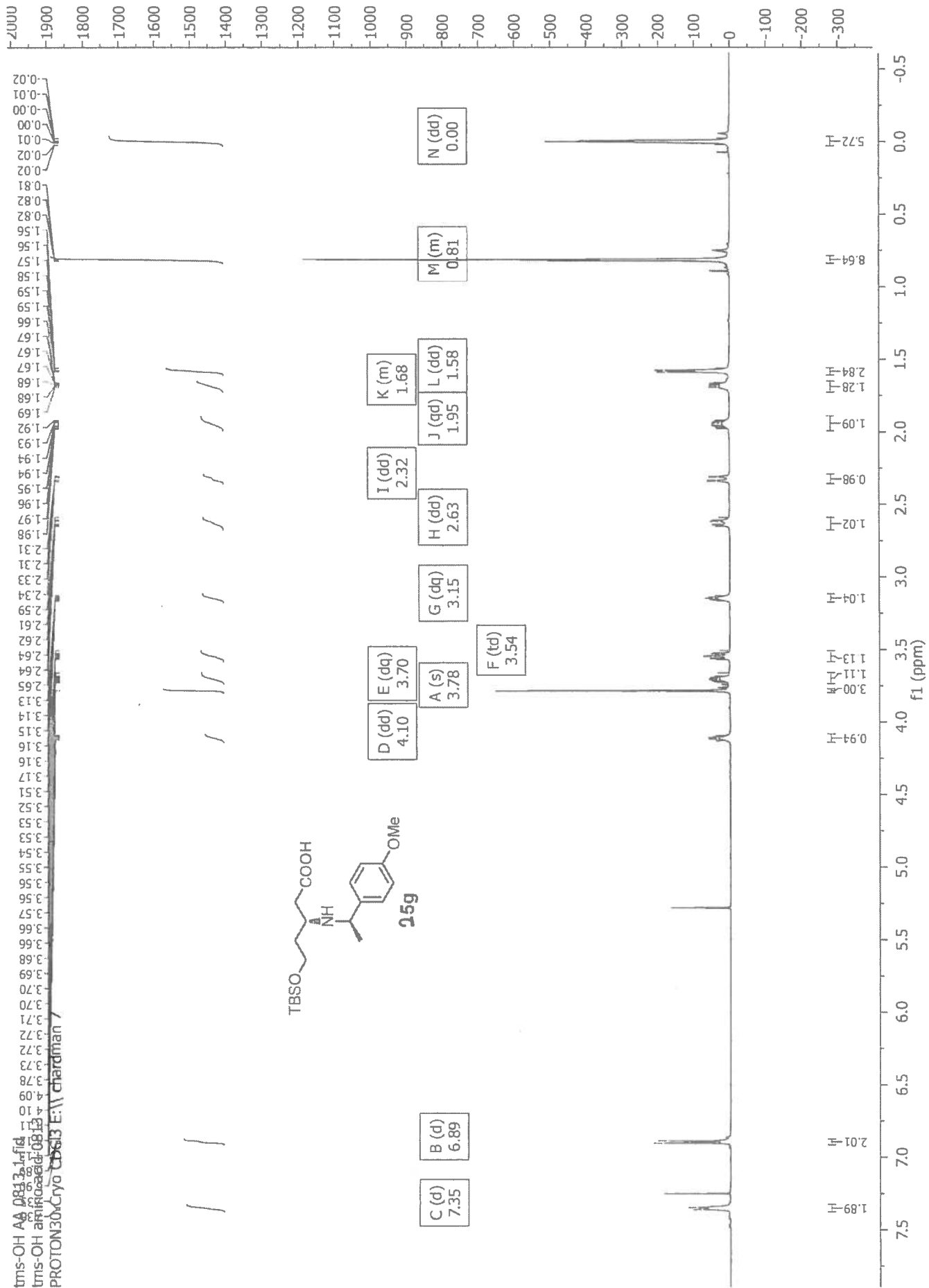

tms-¹³C AA 0813.2.fid
tms-¹³C amino aci 0813
CARBON_TCL_1024 CDCl3 E:\\ chardman 7

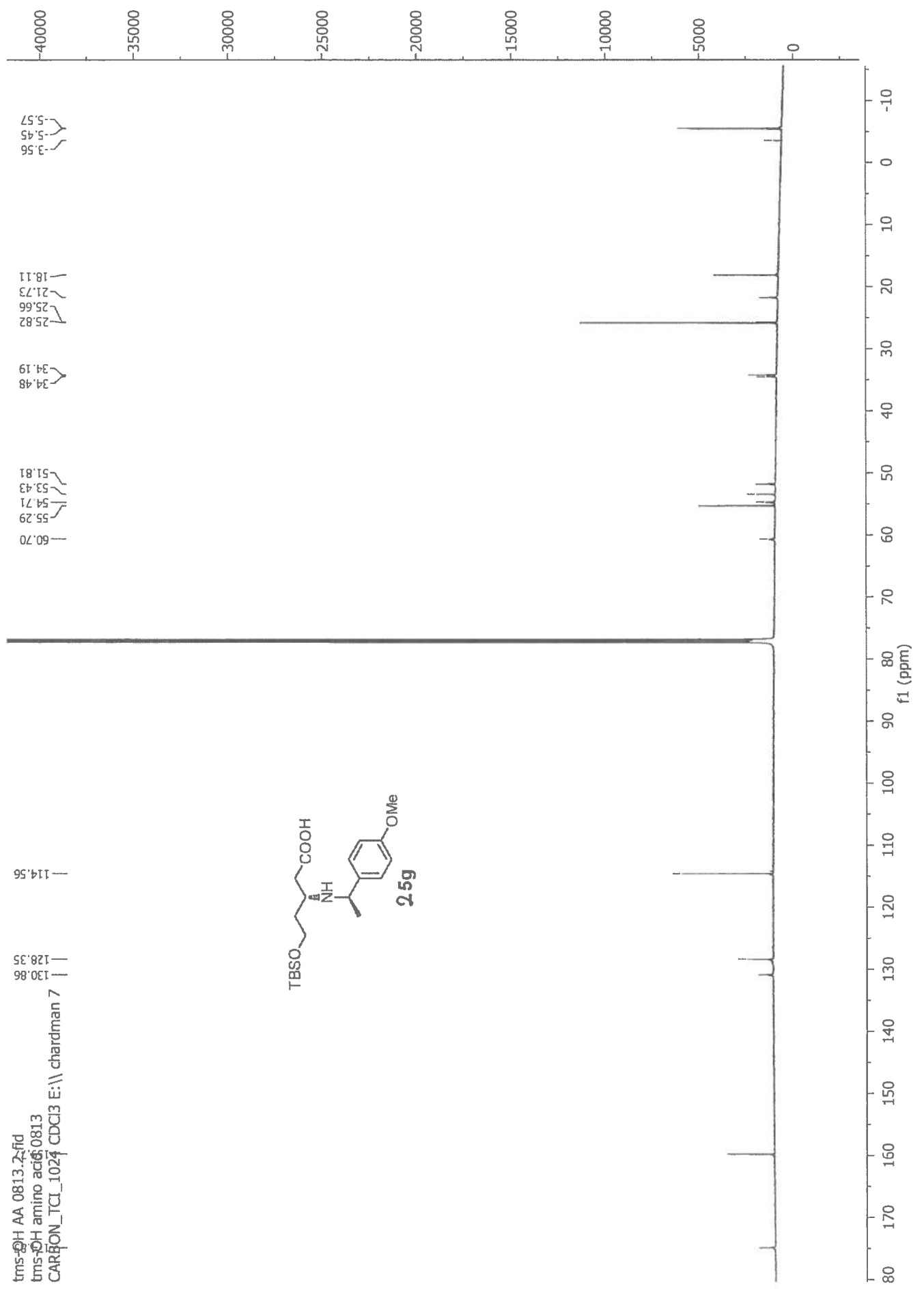
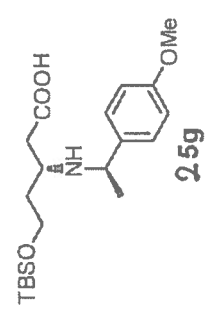

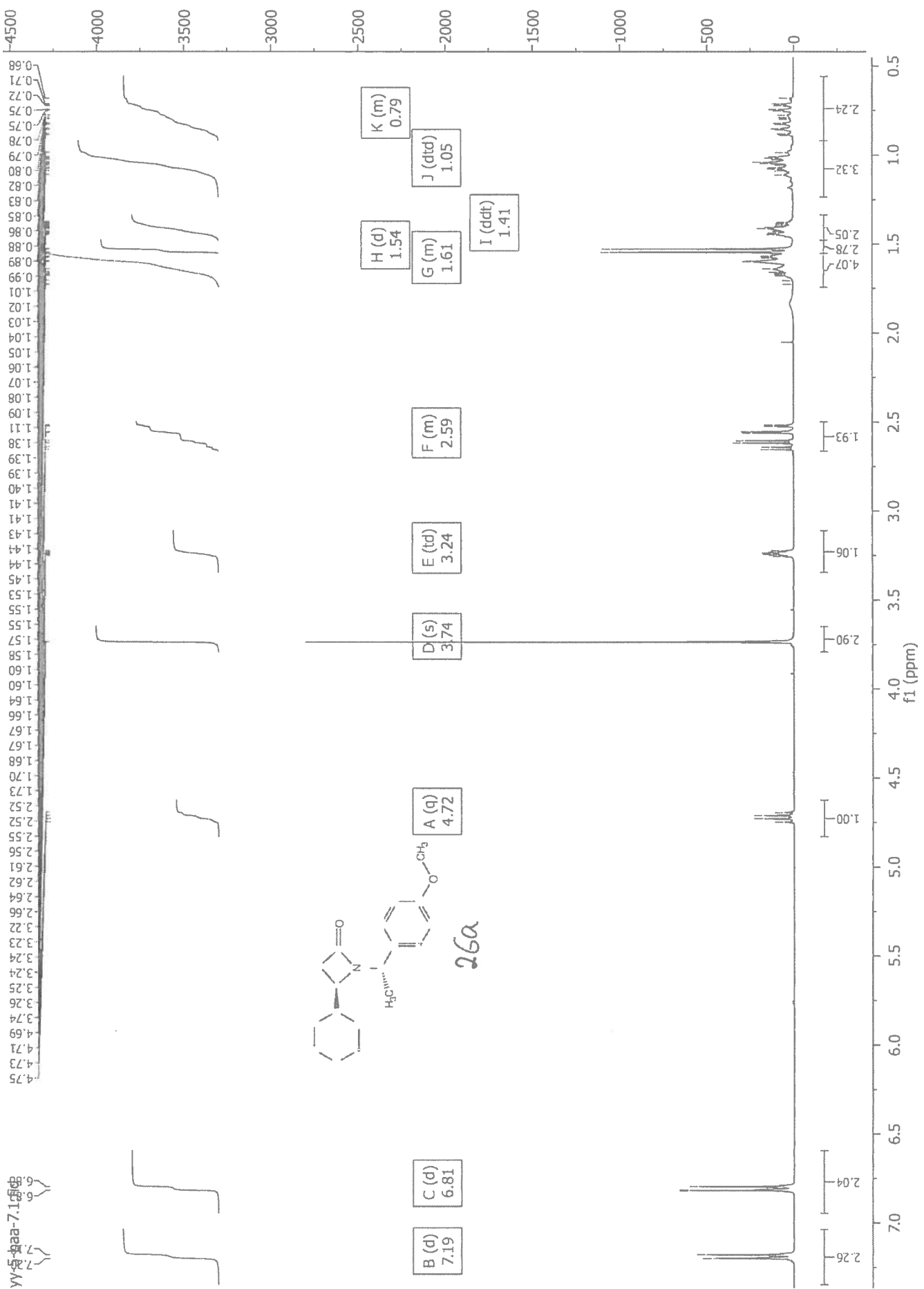

yy-5-baa-7.2.tif

167.8
158.9

132.84

128.22

113.89

56.18
55.28
52.21

39.68
37.48

29.71
26.38
26.03
25.89
25.68
19.51

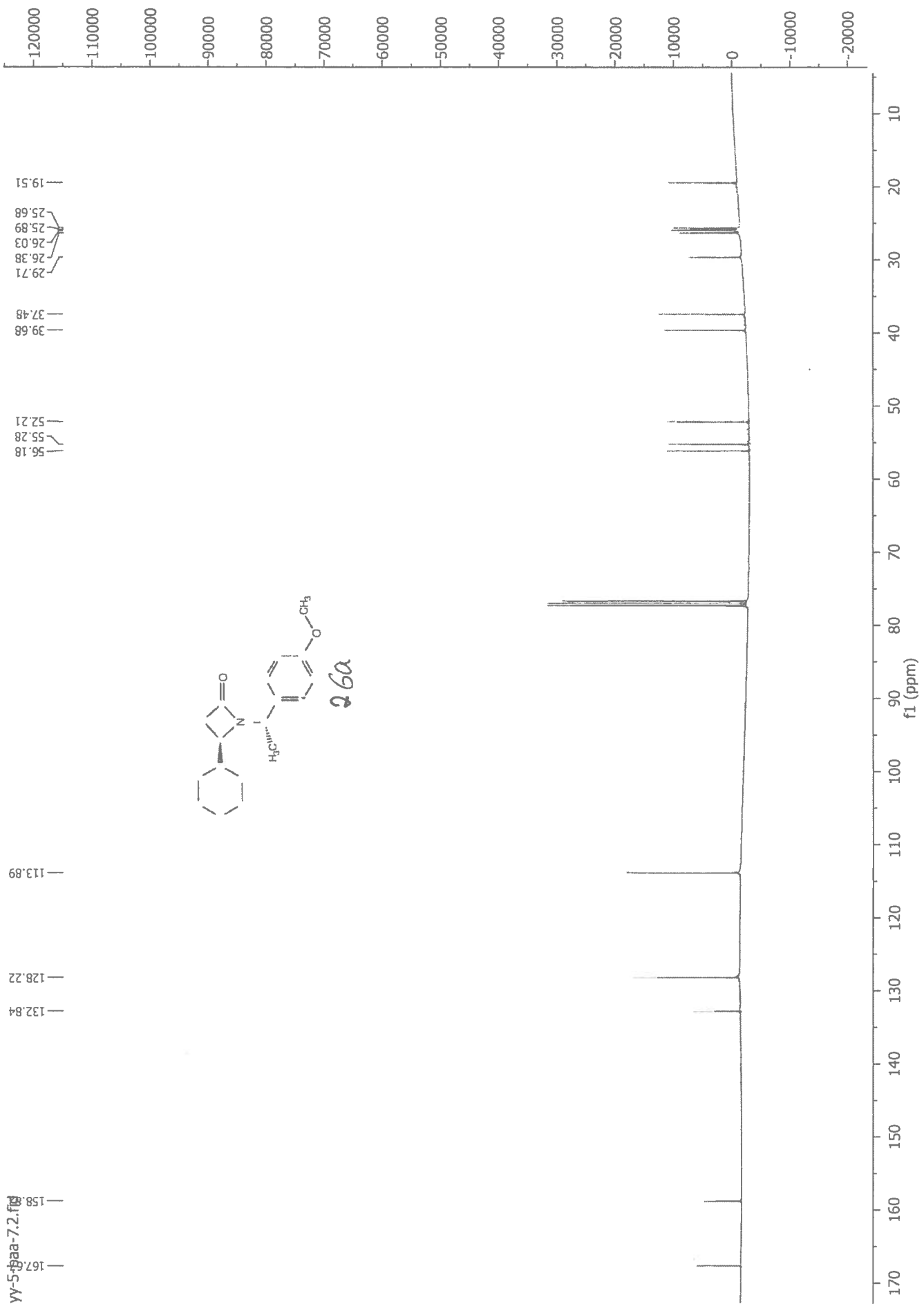
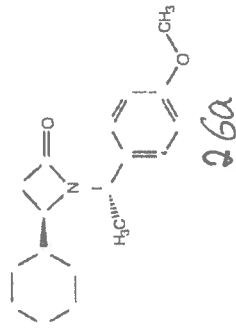

hexclastone 08061511et
 hexentelracone 08061511et
 PROTON30-Cryo CDCl3 E:\ chardman 5

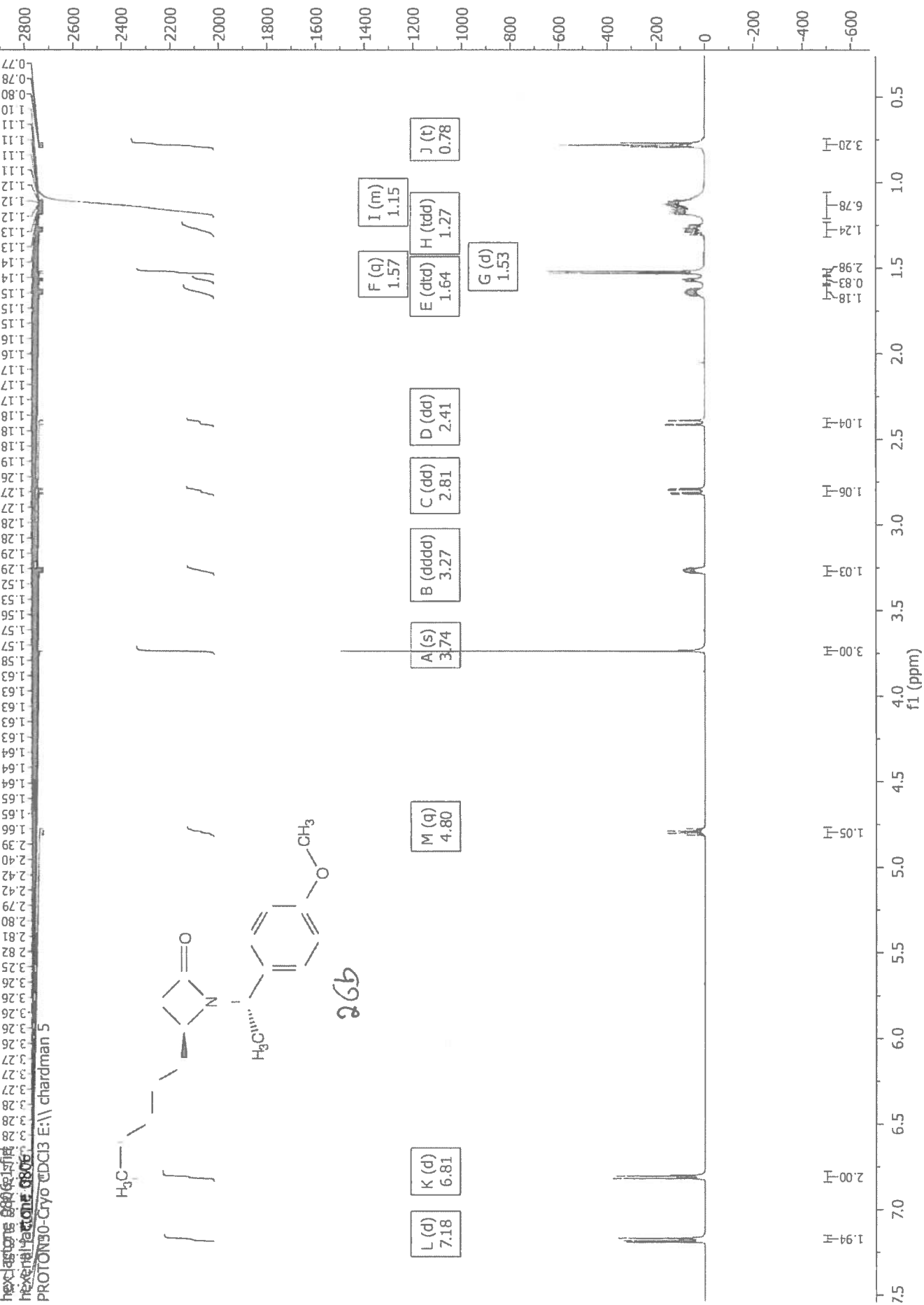
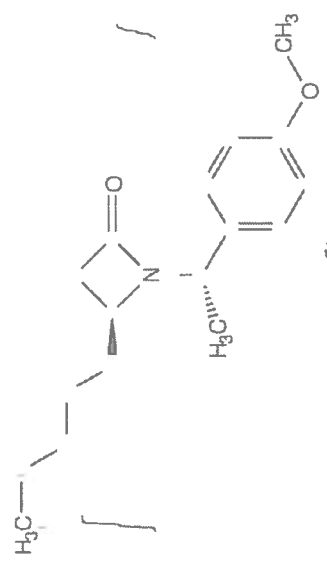

hex:lactone 0806.2.fid
hex:lactone 0806
Carbpn_TCI CDCl3 E:\\ chardman 5

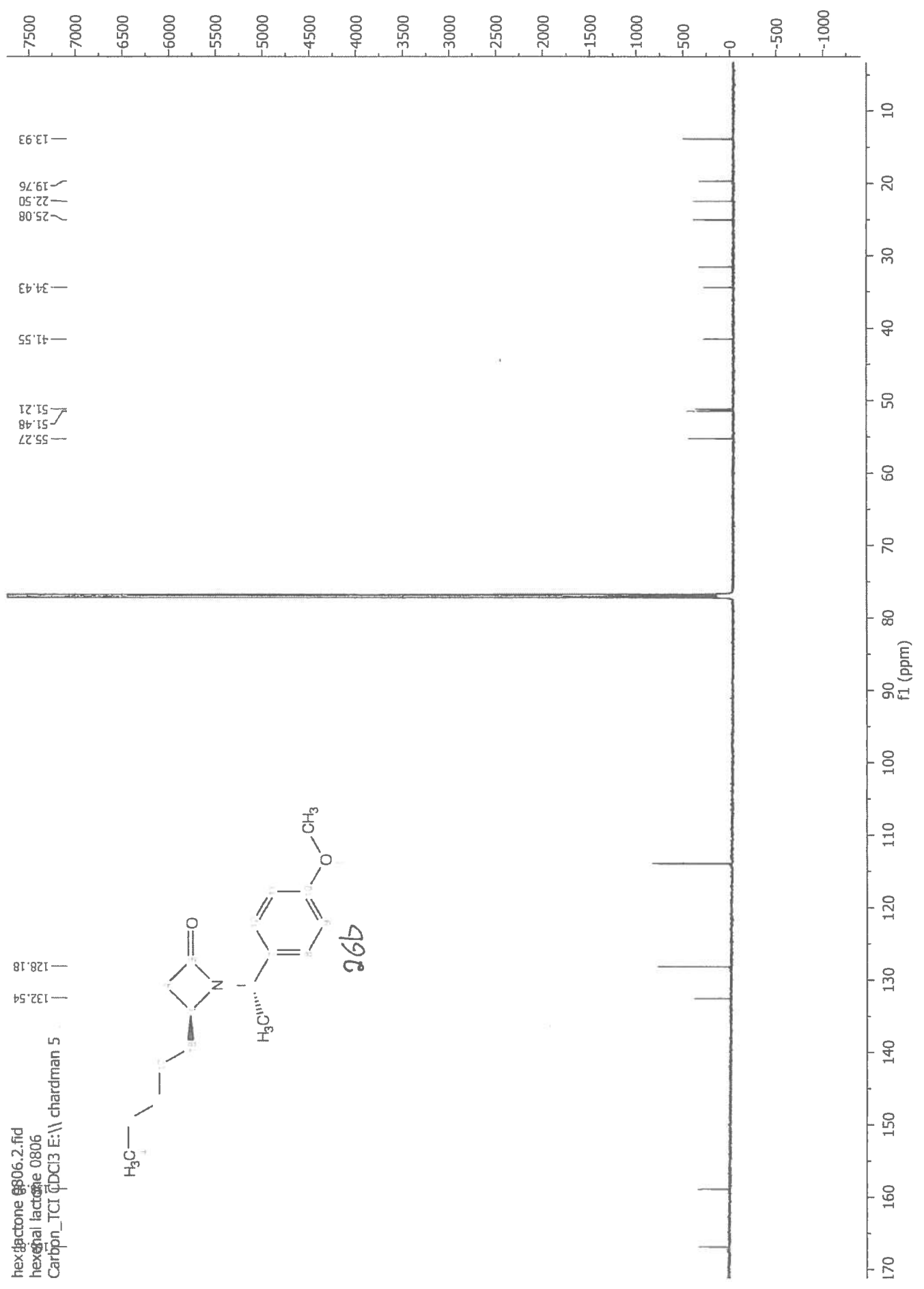
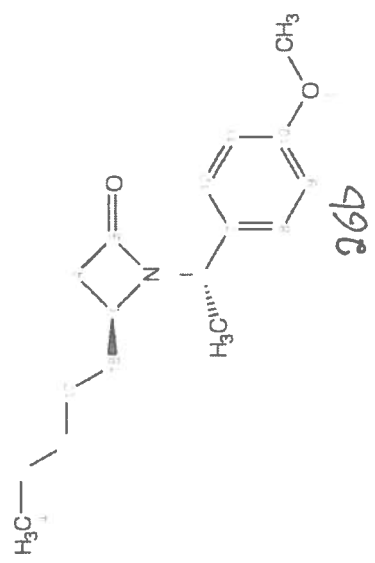

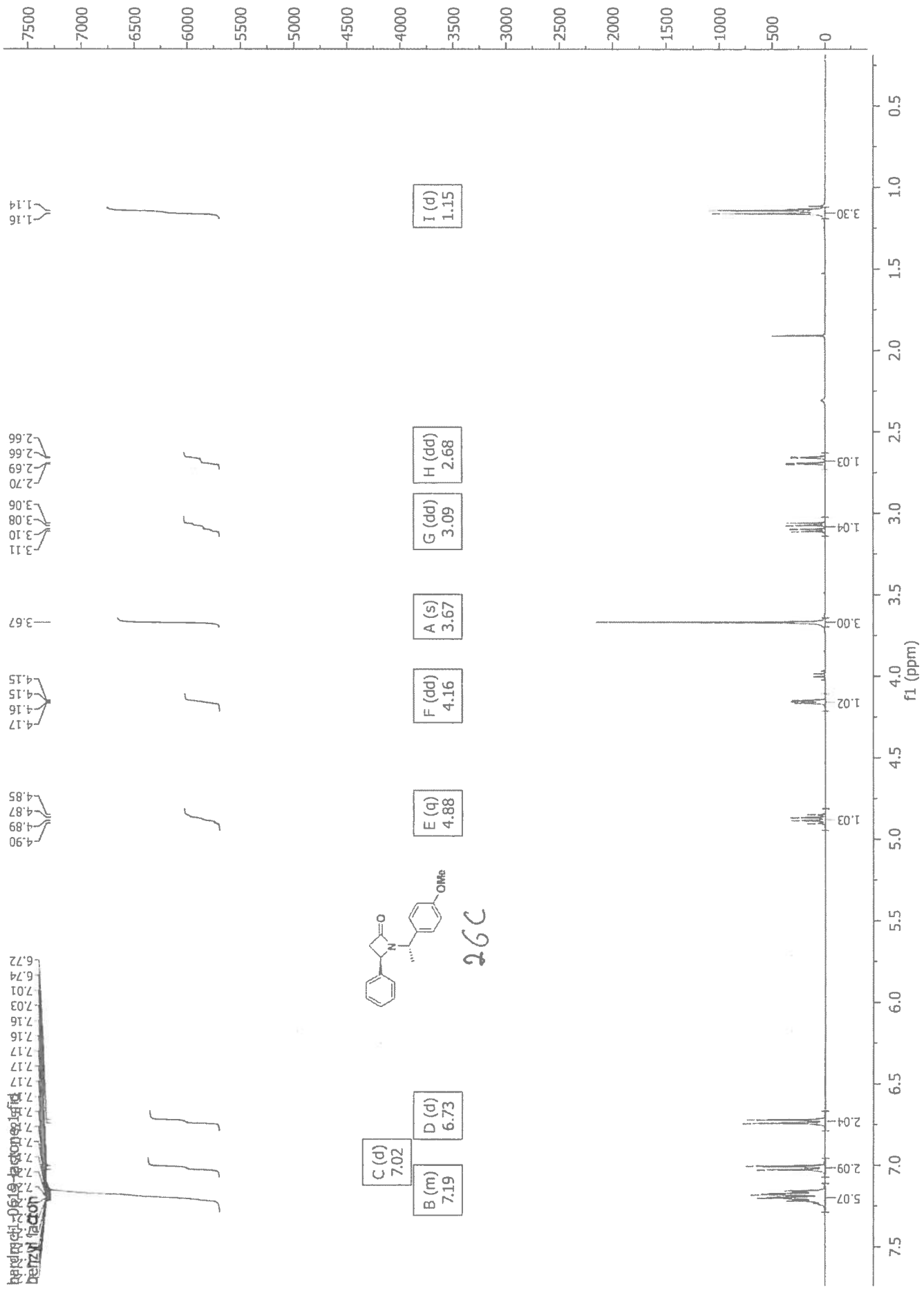

26C

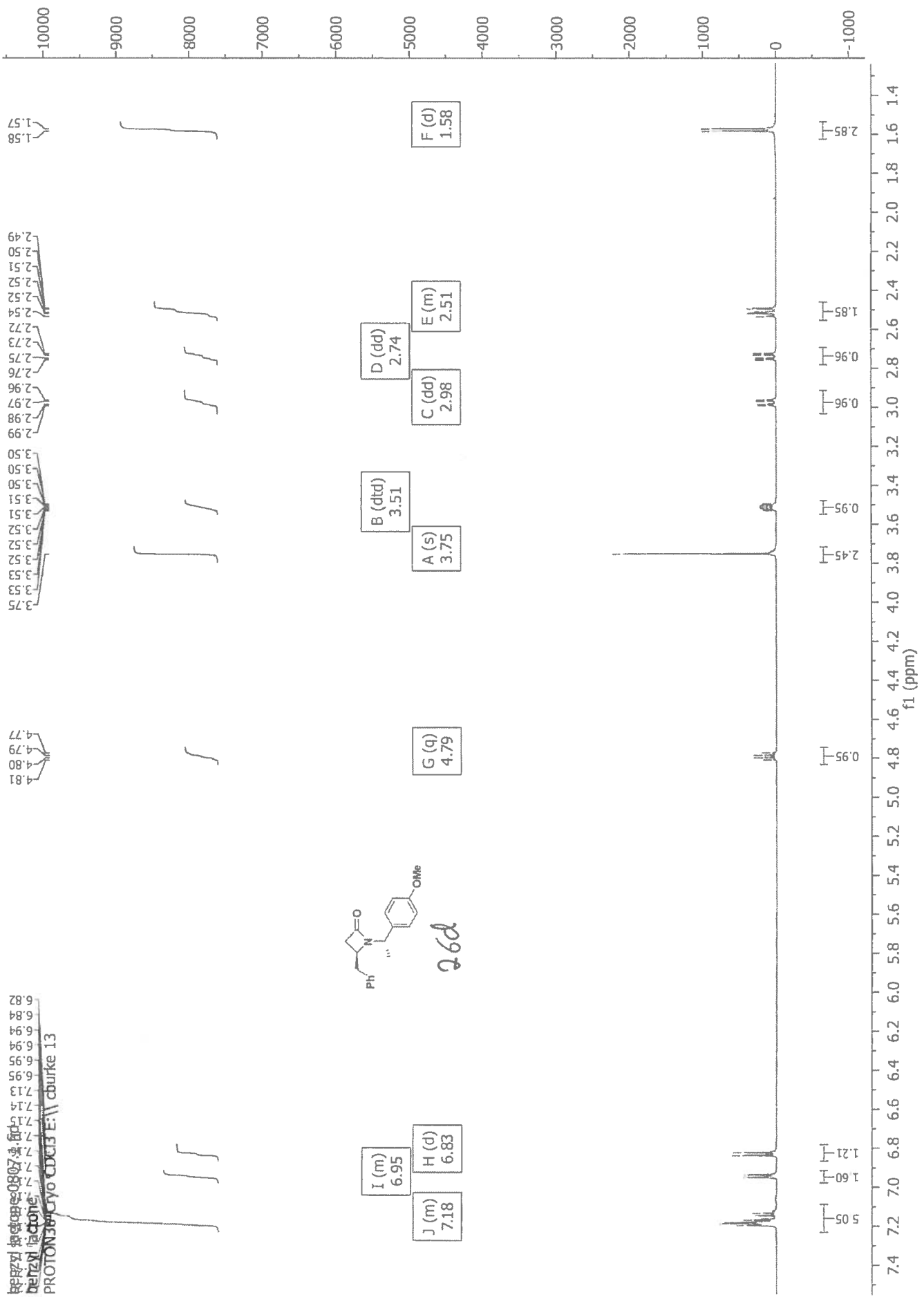

7.18
7.17
7.16
7.15
7.14
7.13
6.95
6.95
6.94
6.94
6.84
6.82
 4.81
4.80
4.79
4.77
 3.75
3.53
3.52
3.52
3.51
3.51
3.50
3.50
2.99
2.98
2.97
2.76
2.75
2.73
2.72
2.54
2.52
2.52
2.51
2.50
2.49
 1.58
1.57

7.18
7.17
7.16
7.15
7.14
7.13
6.95
6.95
6.94
6.94
6.84
6.82
 4.81
4.80
4.79
4.77
 3.75
3.53
3.52
3.52
3.51
3.51
3.50
3.50
2.99
2.98
2.97
2.76
2.75
2.73
2.72
2.54
2.52
2.52
2.51
2.50
2.49
 1.58
1.57

PROTONS: cryo cdcl3 f1: cburke 13
 08202013
 13072013

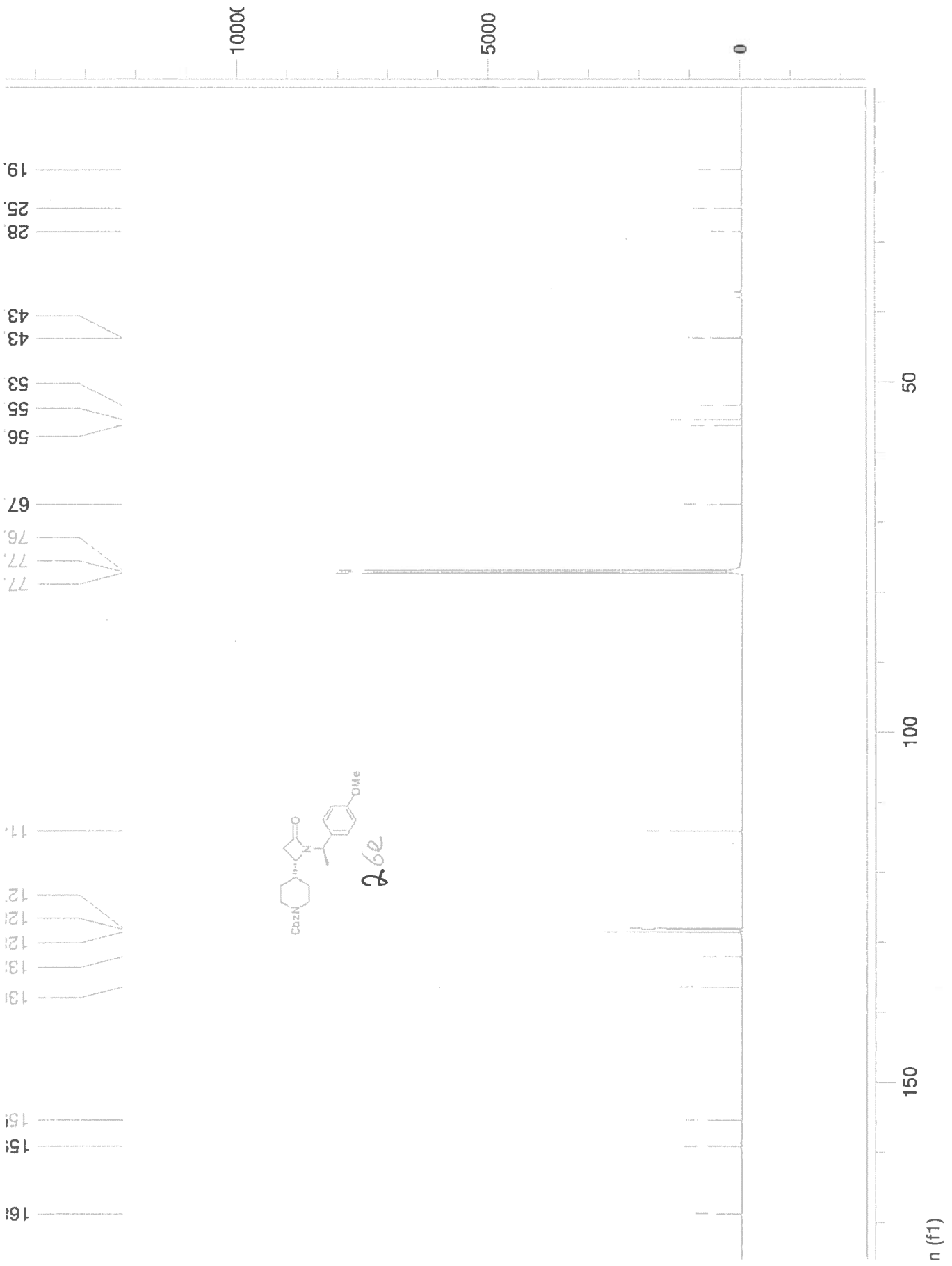

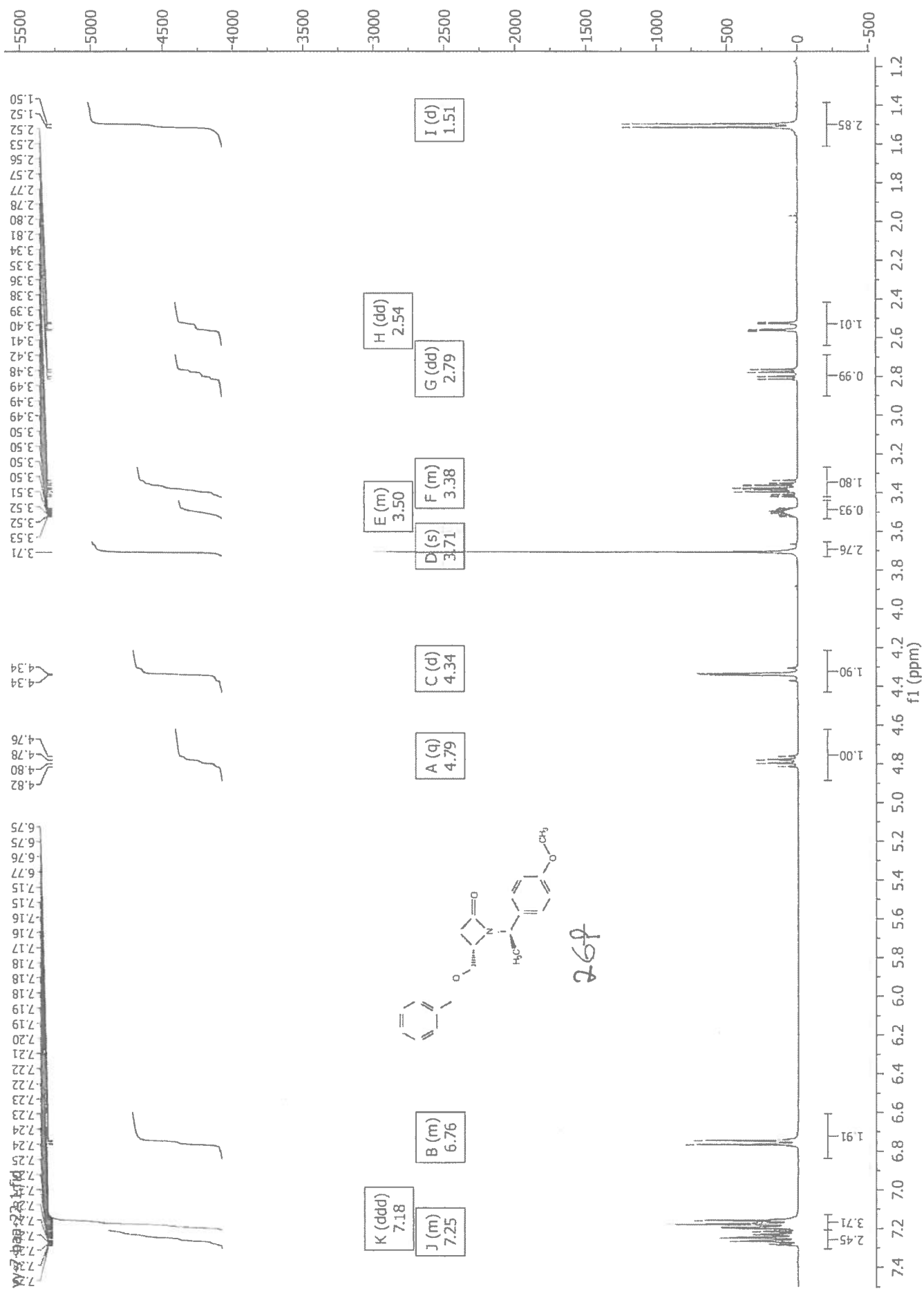

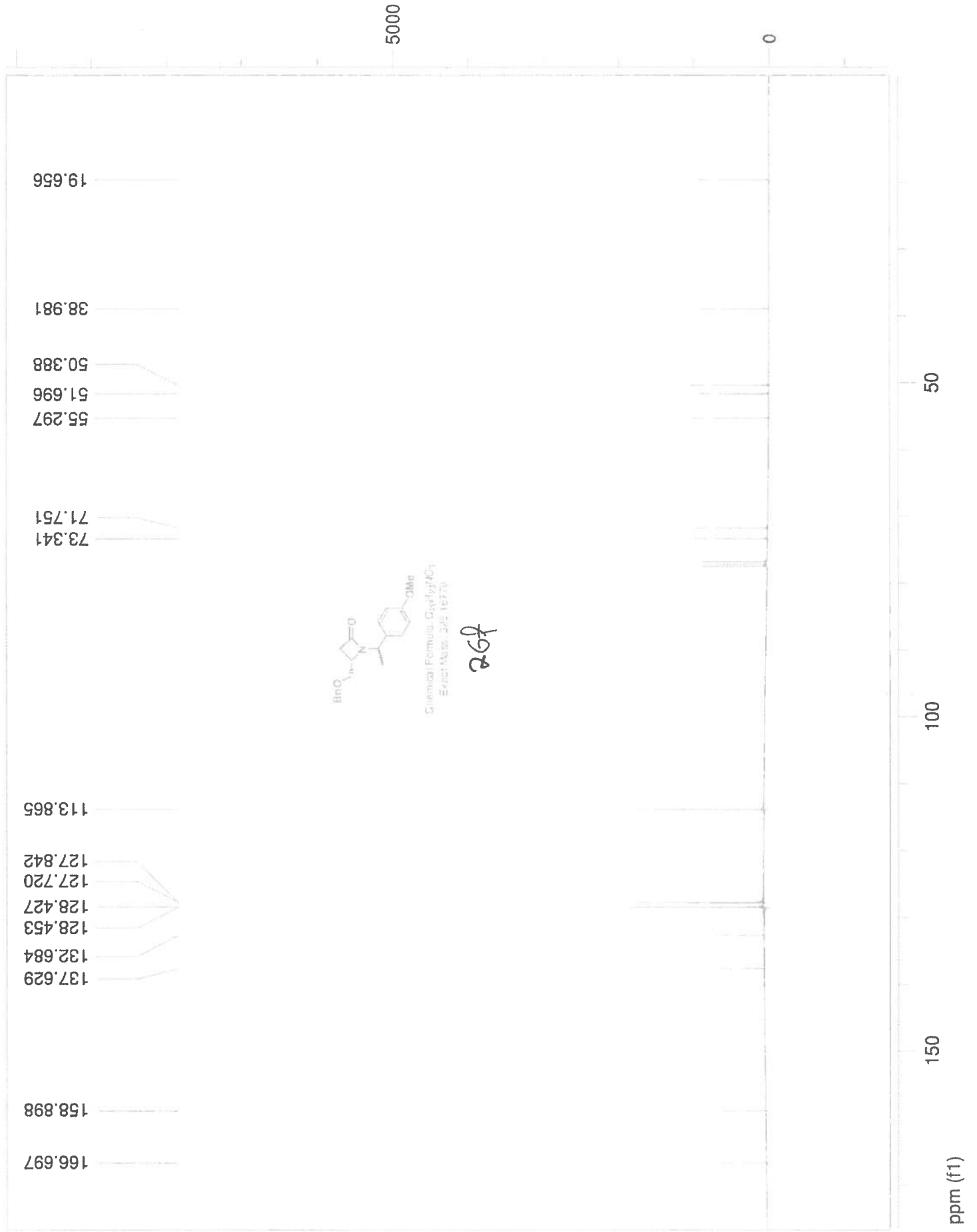

TMS-protected lactone (VMR) 0814_2.fid
TMS-protected lactone
CARBON_TCI_1024 CDCl3 E:\Wyang IP

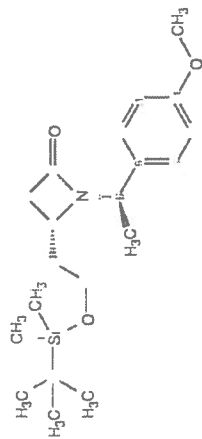

26g

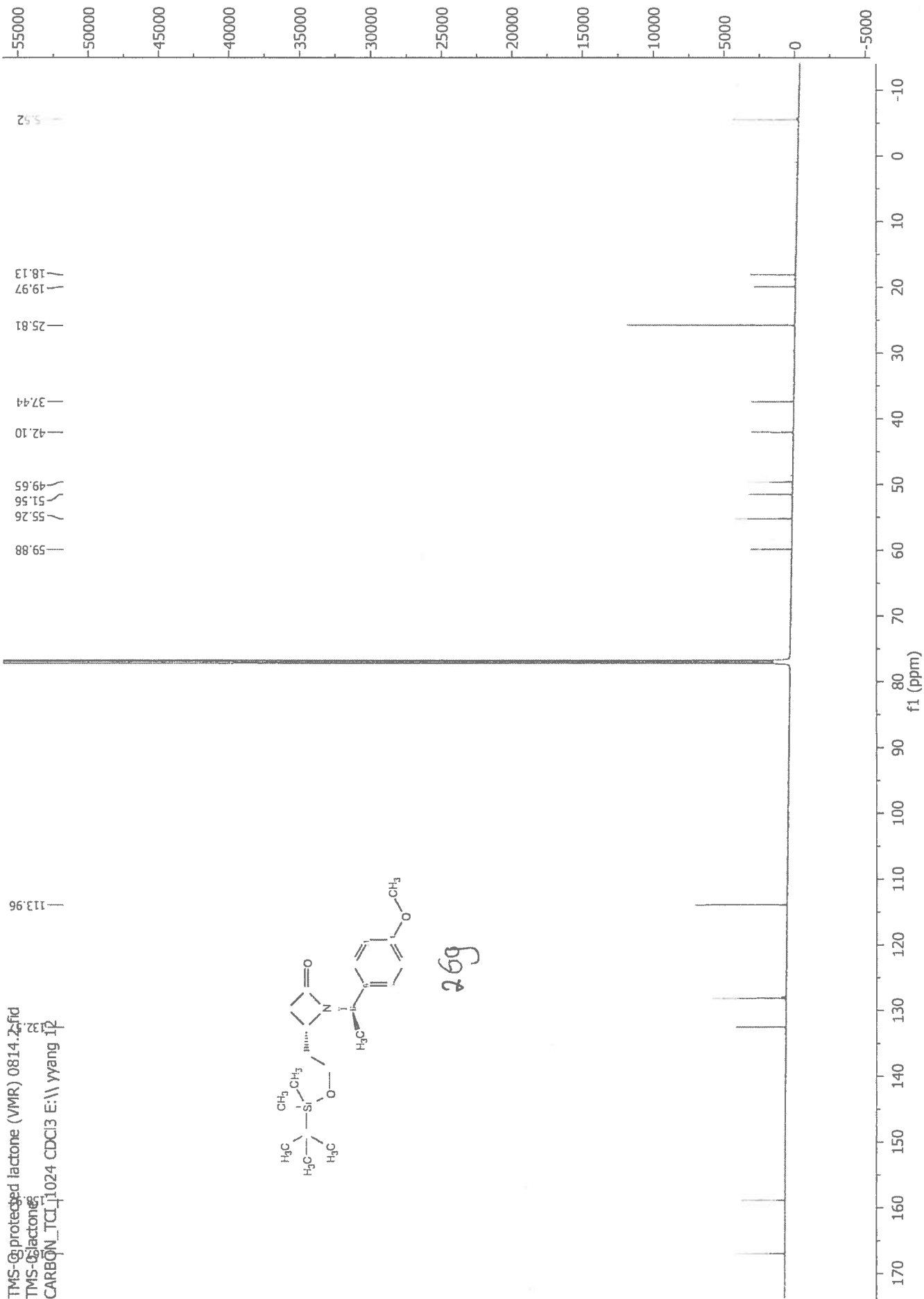

baa-29.1.fid

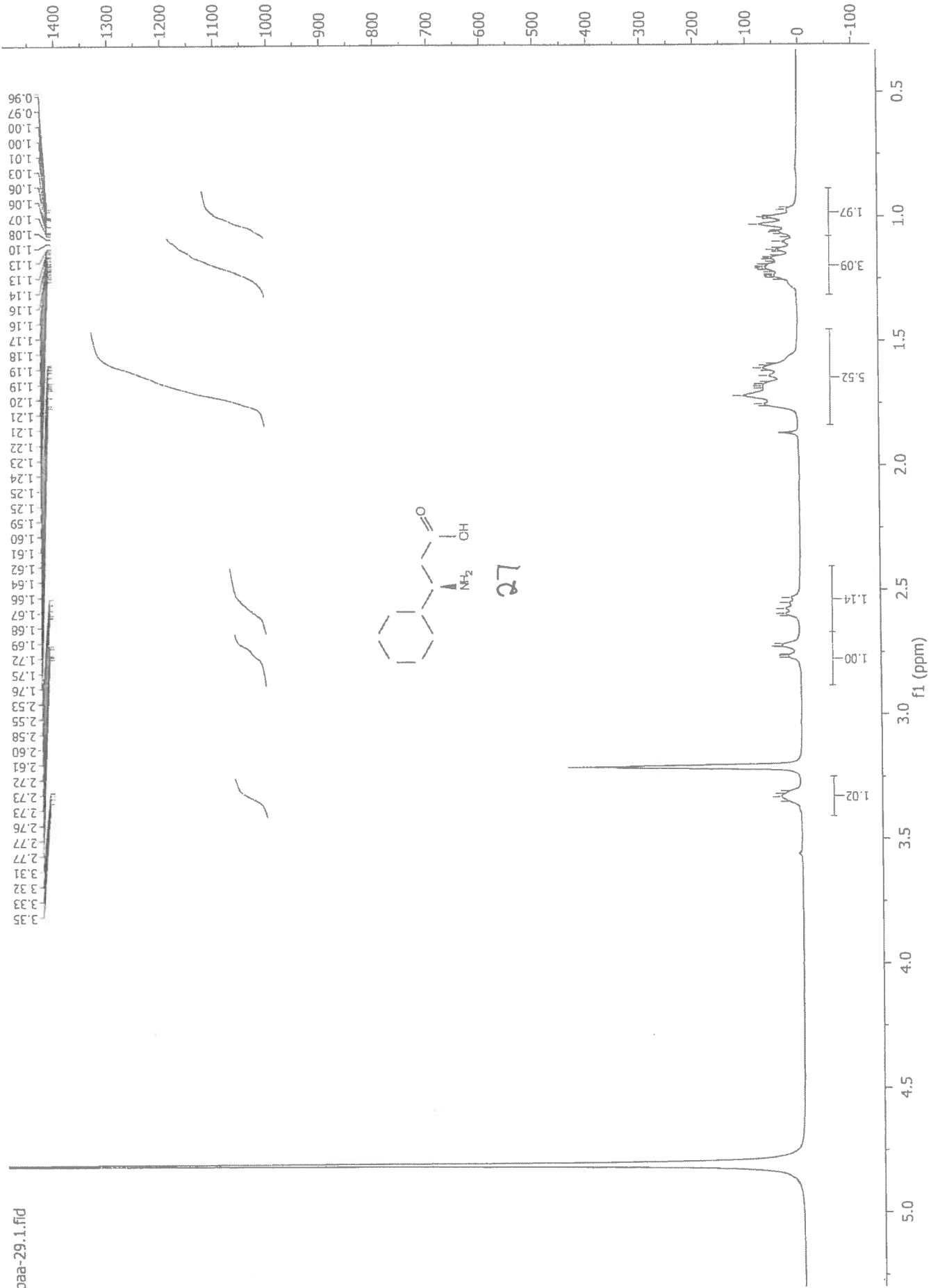

1D — baa-29.3.fid —

— 174.36

101.42
101.40

— 54.34

— 41.33

— 34.98

29.72
29.18
26.97

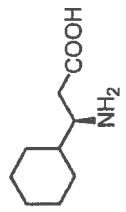

27

