

**Strong N–H···N hydrogen bonds and weak N–H···S=C
interactions in controlling structure of co-crystals of
dithiooxamide with nitrogen heterocycles**

Barbara Piotrkowska,^a Aleksandra Wasilewska,^a Maria Gdaniec ^{*b} and Tadeusz Poloński ^{*a}

^a Department of Chemistry, Gdańsk University of Technology, 80-952 Gdansk, Poland; E-mail: tadpol@chem.pg.gda.pl

^b Faculty of Chemistry, A. Mickiewicz University, 60-780 Poznań, Poland; E-mail: magdan@amu.edu.pl

Supplementary Material

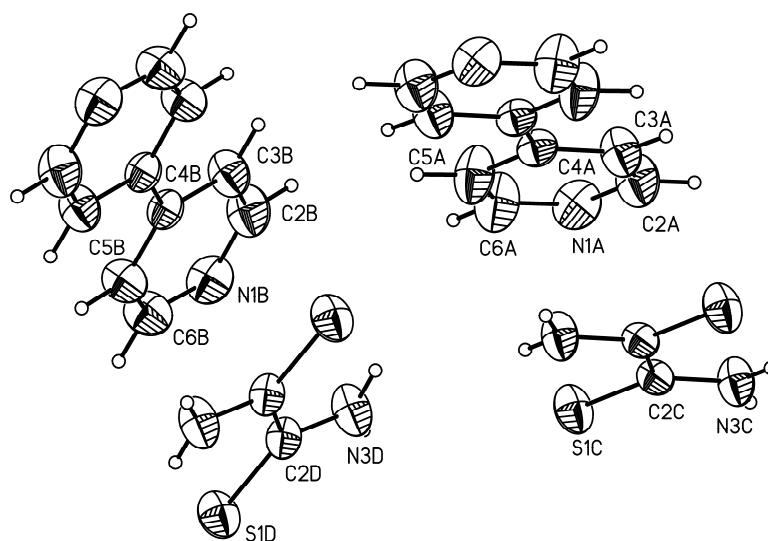

Fig. 1s Ortep drawing of **dtox·1** with displacement ellipsoids shown at the 50% probability level

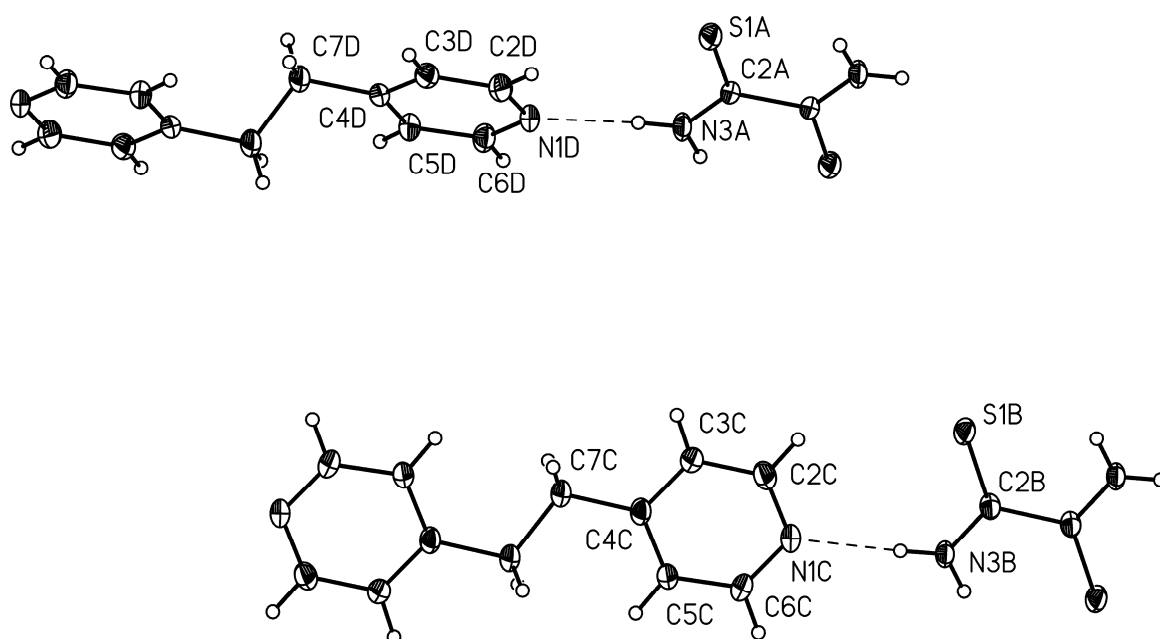

Fig. 2s Ortep drawing of **dtox·2** with displacement ellipsoids shown at the 50% probability level

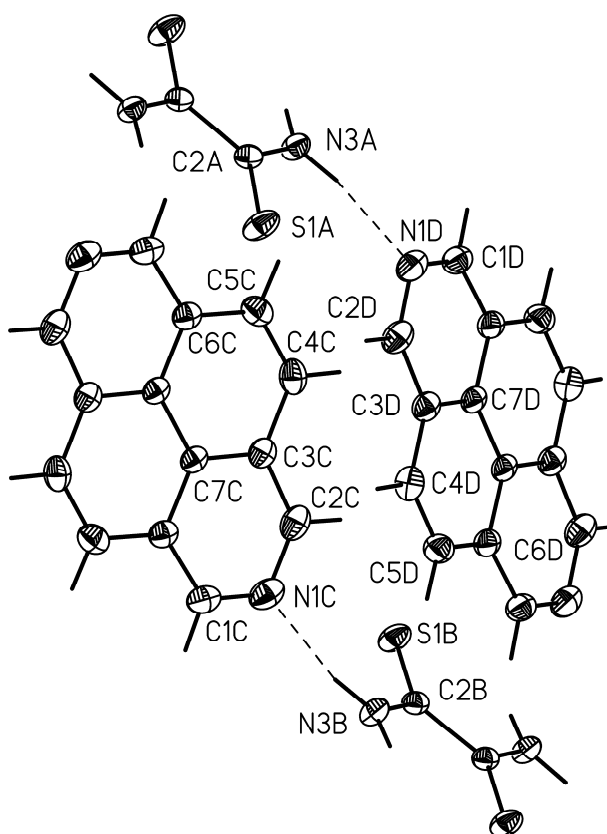

Fig. 3s Ortep drawing of **dtox·3** with displacement ellipsoids shown at the 50% probability level

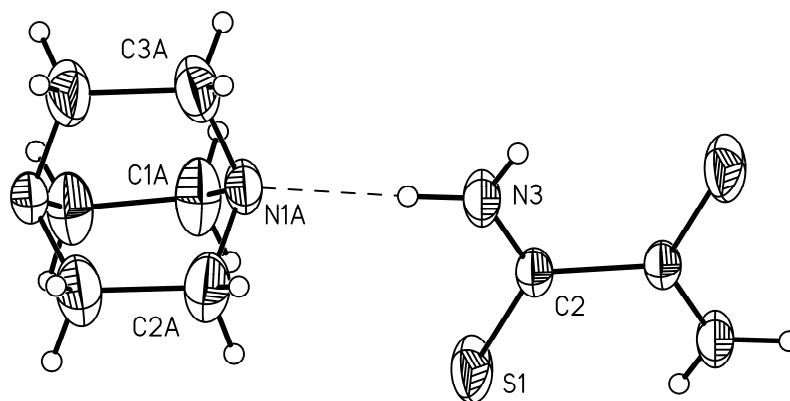

Fig. 4s Ortep drawing of **dtox·4rt** with displacement ellipsoids shown at the 50% probability level

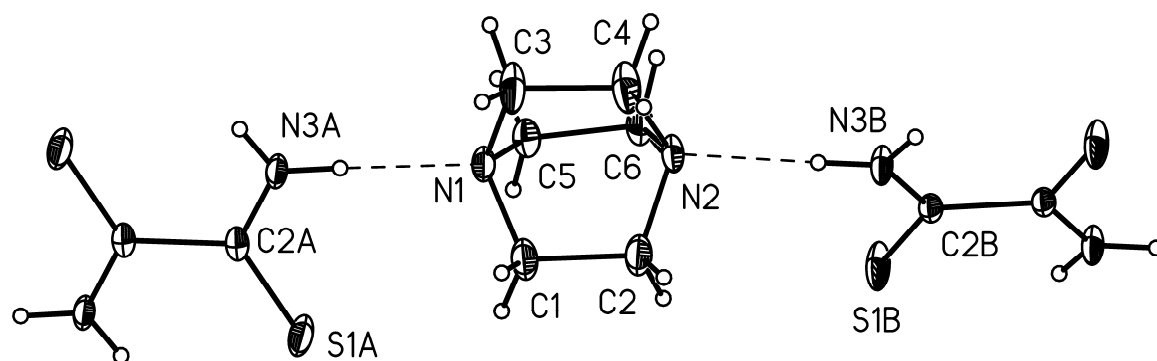

Fig. 5s Ortep drawing of **dtox·4lt** with displacement ellipsoids shown at the 50% probability level

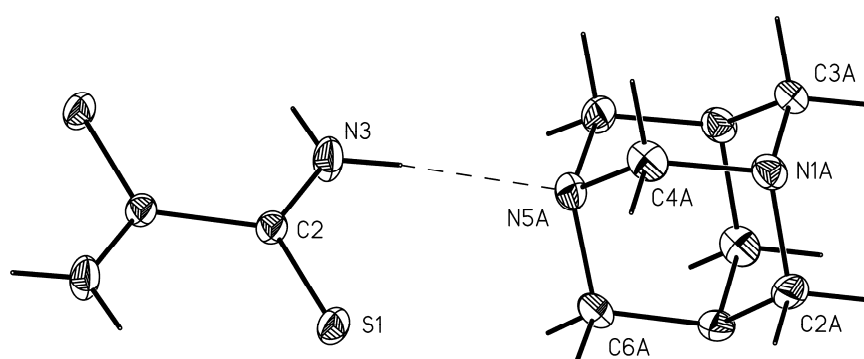

Fig. 6s Ortep drawing of **dtox·5** with displacement ellipsoids shown at the 50% probability level

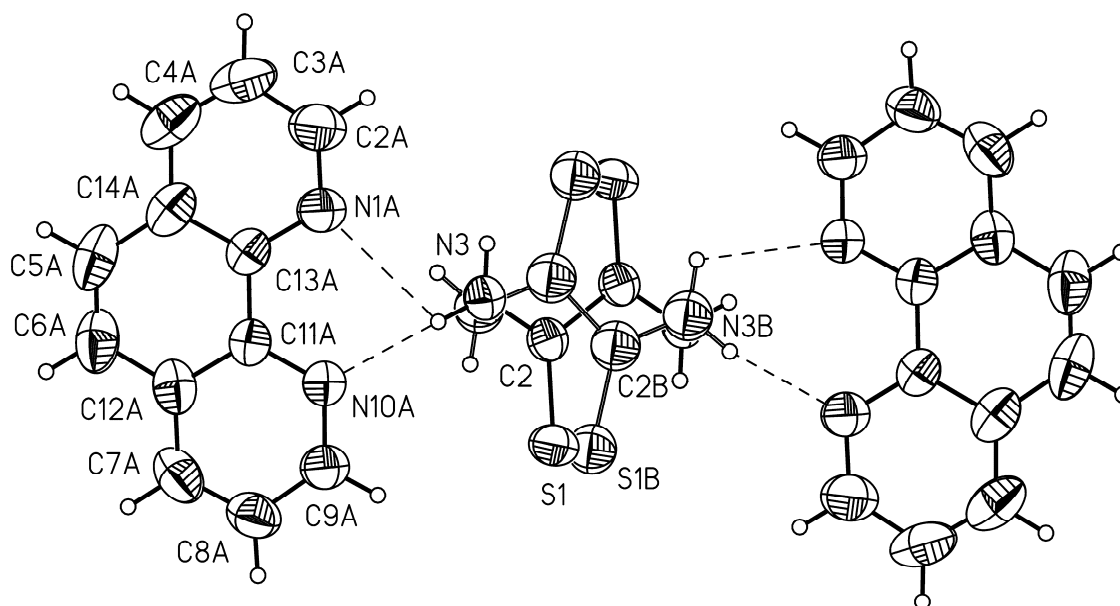

Fig. 7s Ortep drawing of **dtox·6** with displacement ellipsoids shown at the 50% probability level

