

## Supporting Information-II

### NMR Spectral Data

#### Direct Amino Acid-Catalyzed Cascade Biomimetic Reductive Alkylations: Application to the Asymmetric Synthesis of Hajos-Parrish Ketone Analogues

**Dhevalapally B. Ramachary\* and Mamillapalli Kishor**

*School of Chemistry, University of Hyderabad, Central University (P.O.),*

*Hyderabad 500 046, India*

[ramsc@uohyd.ernet.in](mailto:ramsc@uohyd.ernet.in)

	<b>Page No.</b>
<b>CONTENTS</b>	
1. $^1\text{H}$ NMR, $^{13}\text{C}$ NMR and DEPT Spectrums of Compound <b>6a</b>	S4-6
2. $^1\text{H}$ NMR, $^{13}\text{C}$ NMR and DEPT Spectrums of Compound <b>6g</b>	S7-9
3. $^1\text{H}$ NMR, $^{13}\text{C}$ NMR and DEPT Spectrums of Compound <b>7a</b>	S10-12
4. $^1\text{H}$ NMR, $^{13}\text{C}$ NMR and DEPT Spectrums of Compound <b>7b</b>	S13-15
5. $^1\text{H}$ NMR, $^{13}\text{C}$ NMR and DEPT Spectrums of Compound <b>7c</b>	S16-18
6. $^1\text{H}$ NMR, $^{13}\text{C}$ NMR and DEPT Spectrums of Compound <b>7d</b>	S19-21
7. $^1\text{H}$ NMR, $^{13}\text{C}$ NMR and DEPT Spectrums of Compound <b>7e</b>	S22-24
8. $^1\text{H}$ NMR, $^{13}\text{C}$ NMR and DEPT Spectrums of Compound <b>7f</b>	S25-27
9. $^1\text{H}$ NMR, $^{13}\text{C}$ NMR and DEPT Spectrums of Compound <b>7g</b>	S28-30
10. $^1\text{H}$ NMR, $^{13}\text{C}$ NMR and DEPT Spectrums of Compound <b>7h</b>	S31-33
11. $^1\text{H}$ NMR, $^{13}\text{C}$ NMR and DEPT Spectrums of Compound <b>7i</b>	S34-36
12. $^1\text{H}$ NMR, $^{13}\text{C}$ NMR and DEPT Spectrums of Compound <b>7j</b>	S37-39
13. $^1\text{H}$ NMR, $^{13}\text{C}$ NMR and DEPT Spectrums of Compound <b>7k</b>	S40-42
14. $^1\text{H}$ NMR, $^{13}\text{C}$ NMR and DEPT Spectrums of Compound <b>7l</b>	S43-45
15. $^1\text{H}$ NMR, $^{13}\text{C}$ NMR and DEPT Spectrums of Compound <b>7m</b>	S46-48
16. $^1\text{H}$ NMR, $^{13}\text{C}$ NMR and DEPT Spectrums of Compound <b>7n</b>	S49-51
17. $^1\text{H}$ NMR, $^{13}\text{C}$ NMR and DEPT Spectrums of Compound <b>7o</b>	S52-54
18. $^1\text{H}$ NMR, $^{13}\text{C}$ NMR and DEPT Spectrums of Compound <b>7p</b>	S55-57
19. $^1\text{H}$ NMR, $^{13}\text{C}$ NMR and DEPT Spectrums of Compound <b>7q</b>	S58-60
20. $^1\text{H}$ NMR, $^{13}\text{C}$ NMR and DEPT Spectrums of Compound <b>7r</b>	S61-63
21. $^1\text{H}$ NMR, $^{13}\text{C}$ NMR and DEPT Spectrums of Compound <b>7s</b>	S64-66
22. $^1\text{H}$ NMR, $^{13}\text{C}$ NMR and DEPT Spectrums of Compound <b>7t</b>	S67-69

23. <sup>1</sup> H NMR, <sup>13</sup> C NMR and DEPT Spectrums of Compound <b>7u</b>	S70-72
24. <sup>1</sup> H NMR, <sup>13</sup> C NMR and DEPT Spectrums of Compound <b>7v</b>	S73-75
25. <sup>1</sup> H NMR, <sup>13</sup> C NMR and DEPT Spectrums of Compound <b>7w</b>	S76-78
26. <sup>1</sup> H NMR, <sup>13</sup> C NMR and DEPT Spectrums of Compound <b>7x</b>	S79-81
27. <sup>1</sup> H NMR, <sup>13</sup> C NMR and DEPT Spectrums of Compound <b>10a</b>	S82-84
28. <sup>1</sup> H NMR, <sup>13</sup> C NMR and DEPT Spectrums of Compound <b>10l</b>	S85-87
29. <sup>1</sup> H NMR, <sup>13</sup> C NMR and DEPT Spectrums of Compound <b>10m</b>	S88-90
30. <sup>1</sup> H NMR, <sup>13</sup> C NMR and DEPT Spectrums of Compound <b>10n</b>	S91-93
31. <sup>1</sup> H NMR, <sup>13</sup> C NMR and DEPT Spectrums of Compound <b>11a</b>	S94-96
32. <sup>1</sup> H NMR, <sup>13</sup> C NMR and DEPT Spectrums of Compound <b>11l</b>	S97-99
33. <sup>1</sup> H NMR, <sup>13</sup> C NMR and DEPT Spectrums of Compound <b>11m</b>	S100-102
34. <sup>1</sup> H NMR, <sup>13</sup> C NMR and DEPT Spectrums of Compound <b>11n</b>	S103-105
35. <sup>1</sup> H NMR, <sup>13</sup> C NMR and DEPT Spectrums of Compound <b>12a</b>	S106-108
36. <sup>1</sup> H NMR, <sup>13</sup> C NMR and DEPT Spectrums of Compound <b>12l</b>	S109-111
37. <sup>1</sup> H NMR, <sup>13</sup> C NMR and DEPT Spectrums of Compound <b>12m</b>	S112-114
38. <sup>1</sup> H NMR, <sup>13</sup> C NMR and DEPT Spectrums of Compound <b>12n</b>	S115-117
39. <sup>1</sup> H NMR, <sup>13</sup> C NMR and DEPT Spectrums of Compound <b>13a</b>	S118-120
40. <sup>1</sup> H NMR, <sup>13</sup> C NMR and DEPT Spectrums of Compound <b>13l</b>	S121-123
41. <sup>1</sup> H NMR, <sup>13</sup> C NMR and DEPT Spectrums of Compound <b>13w</b>	S124-126

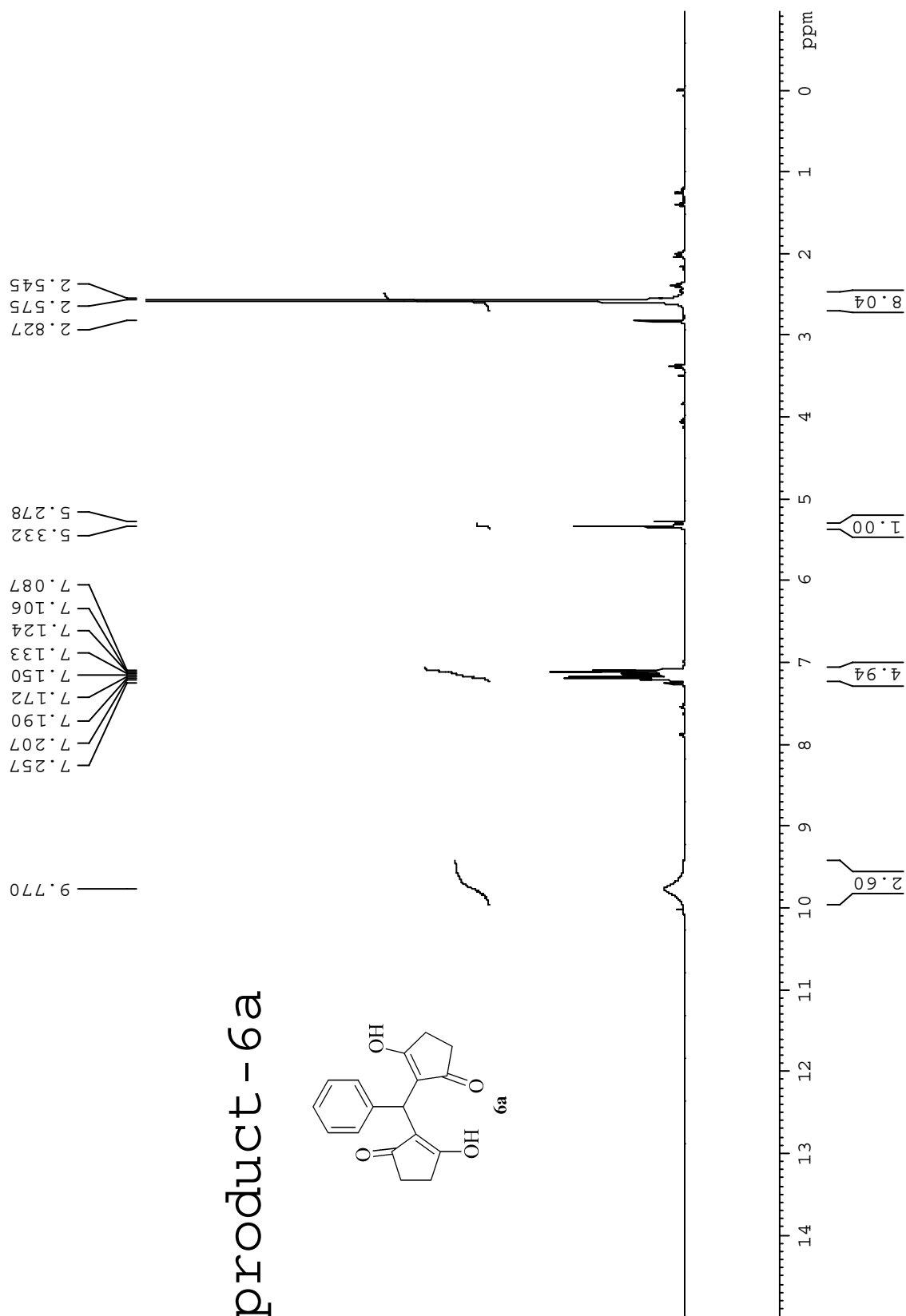

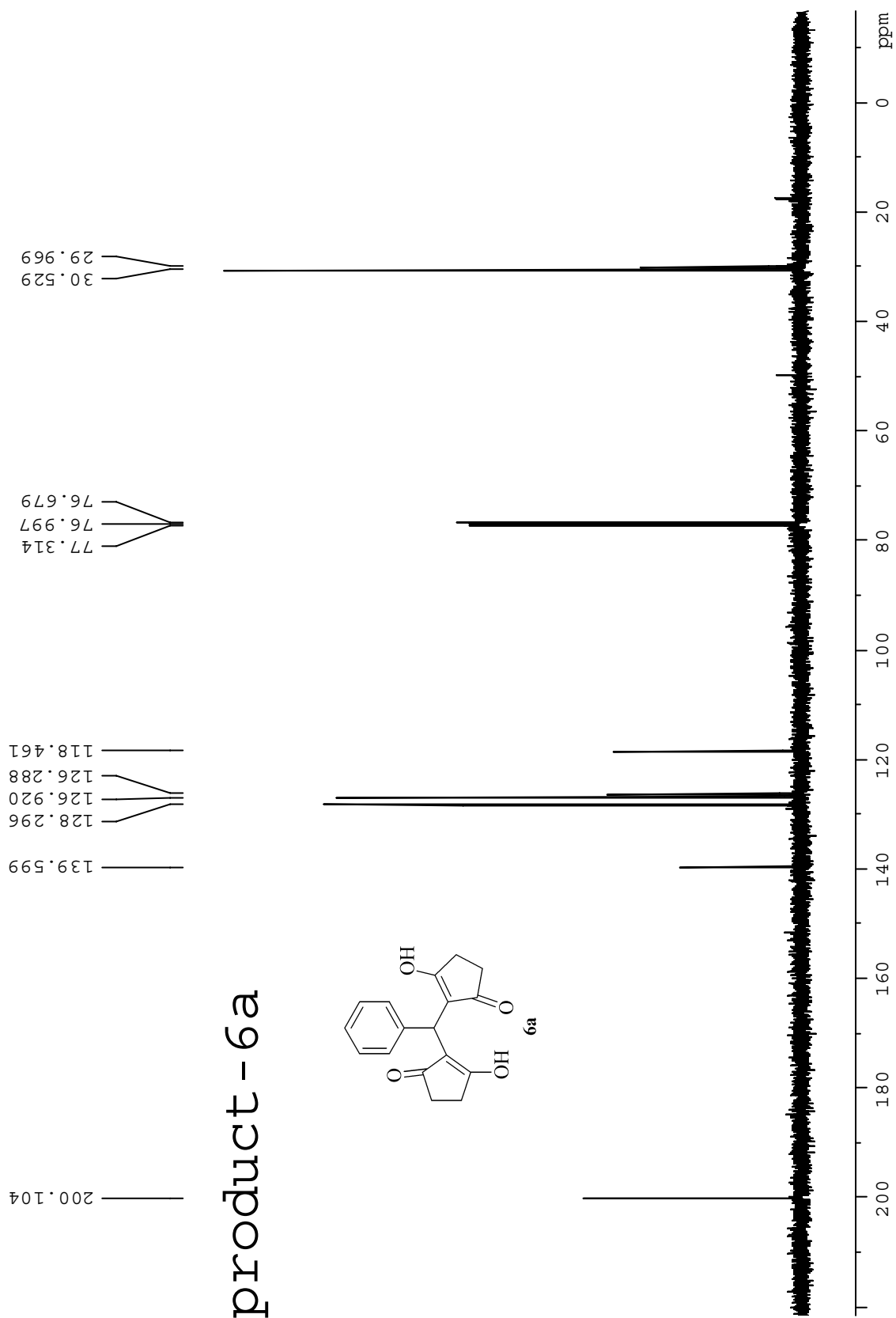

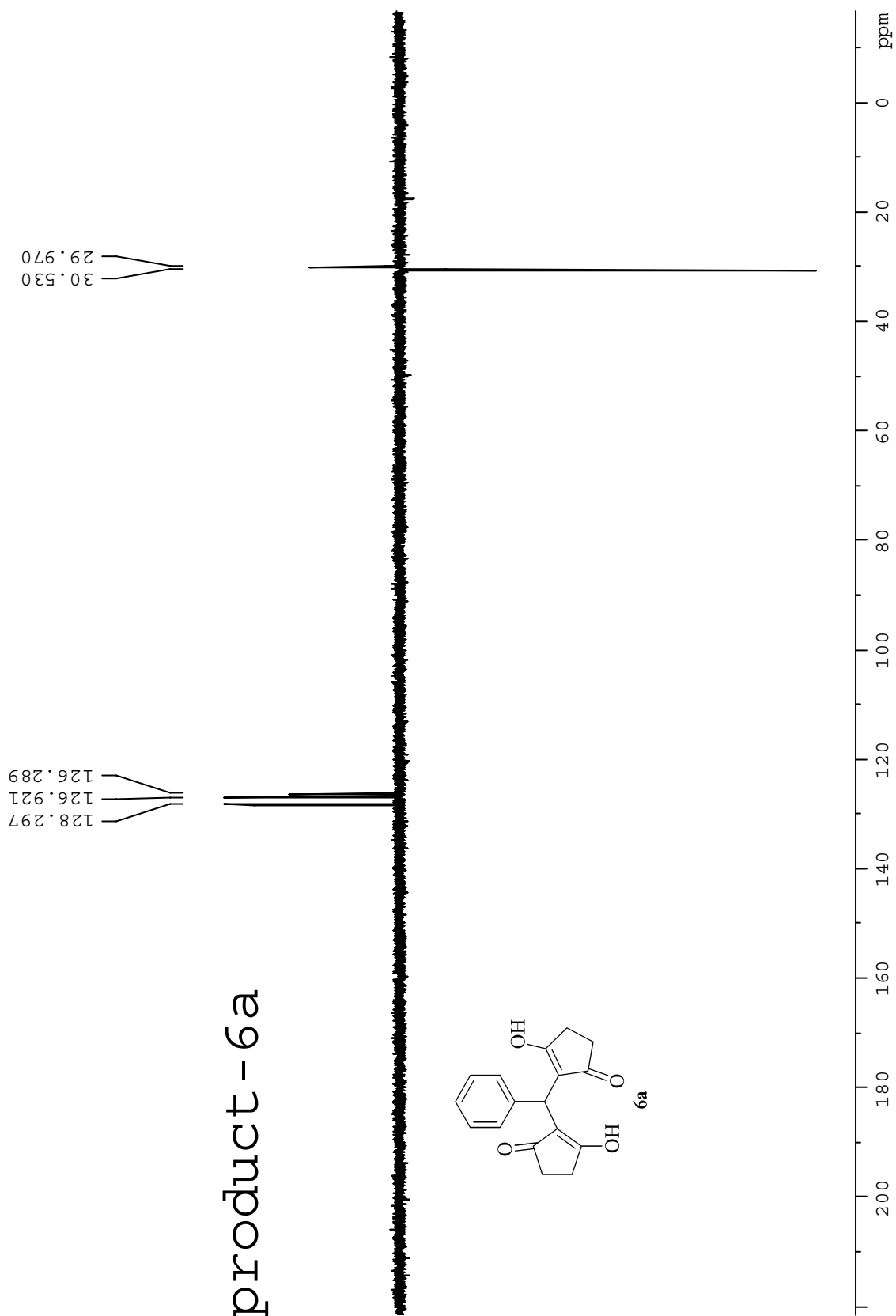

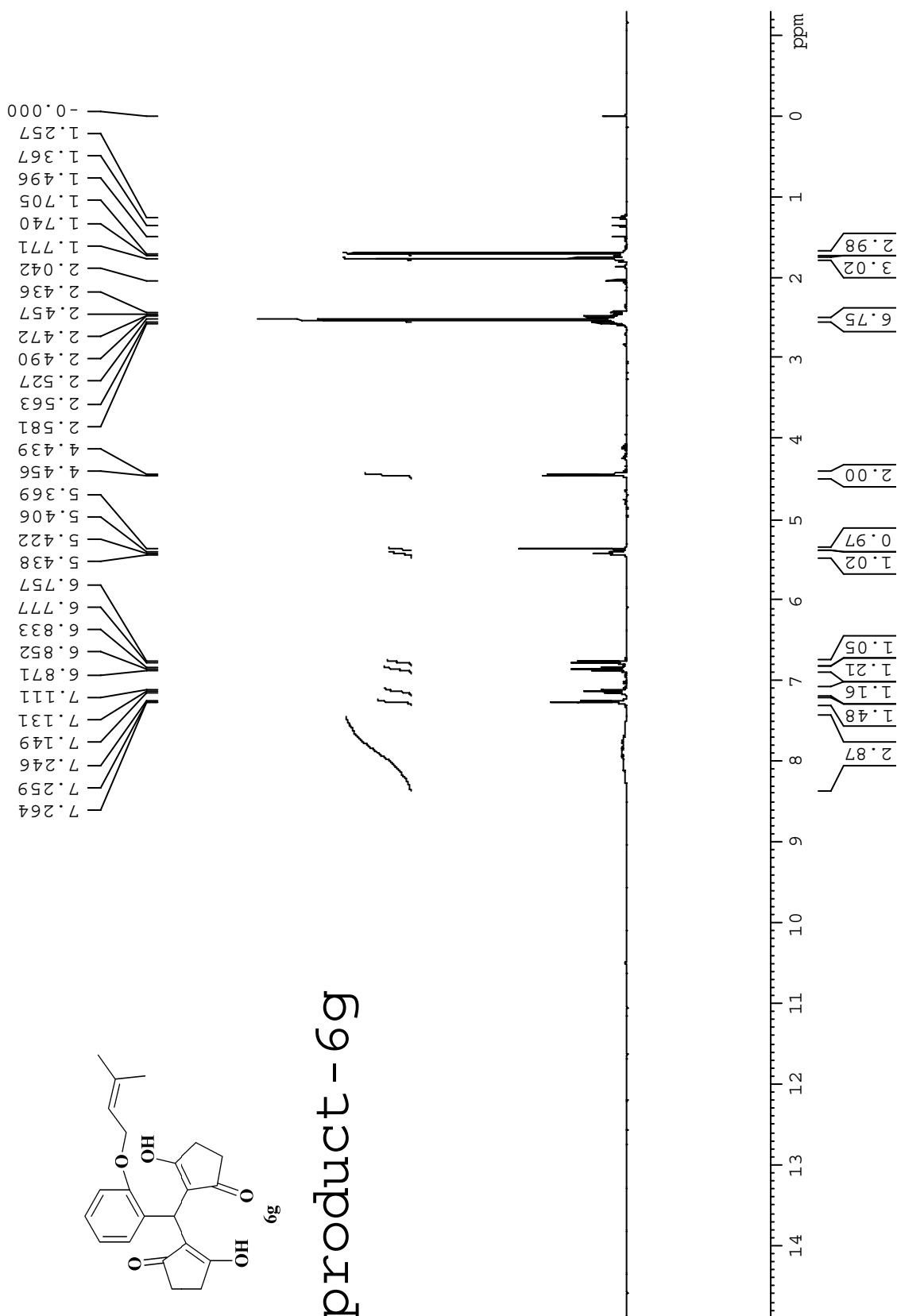

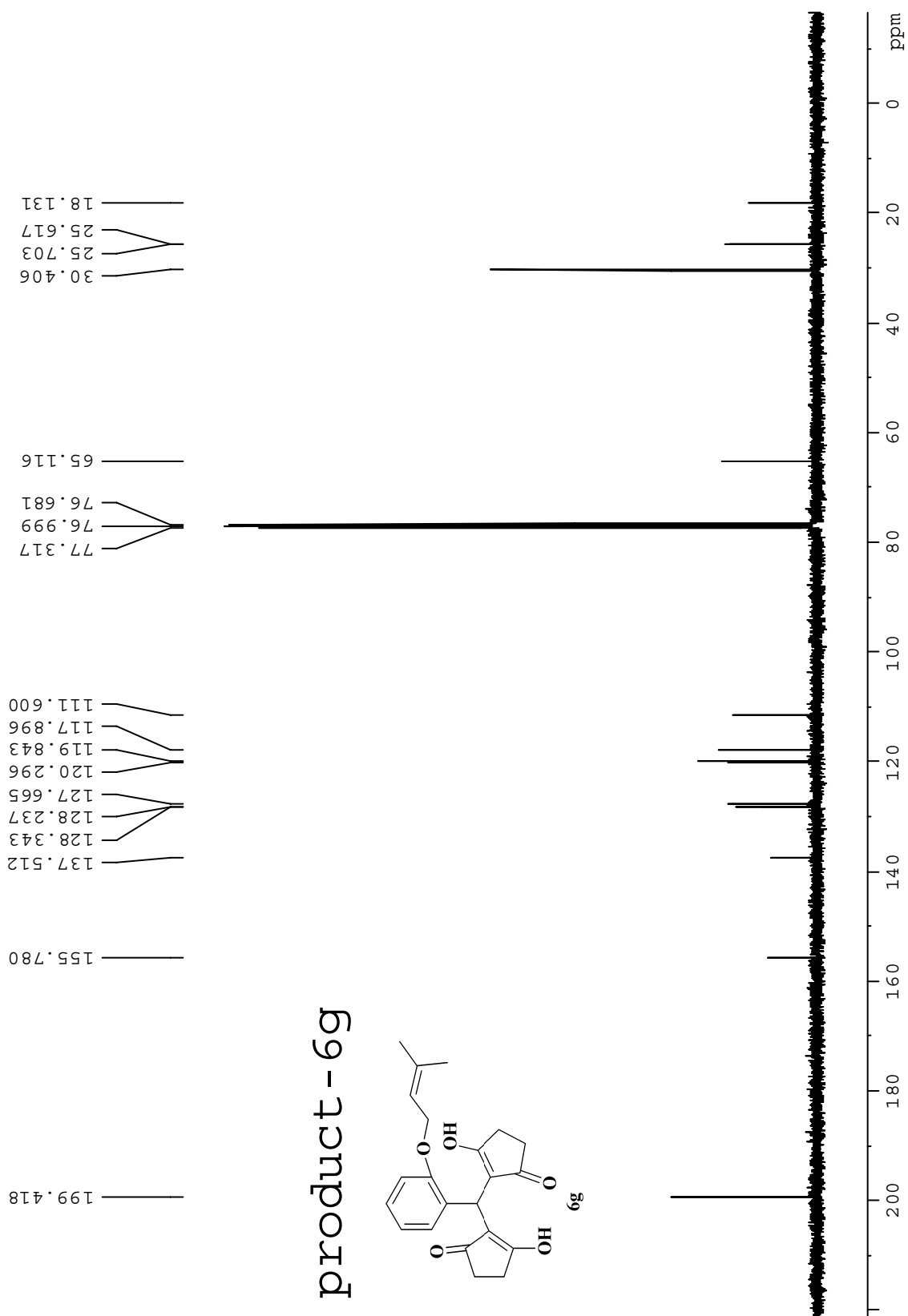



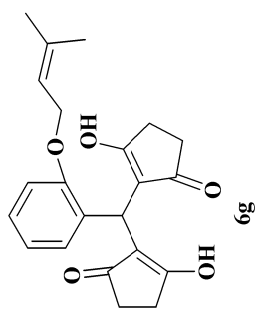

product - 69

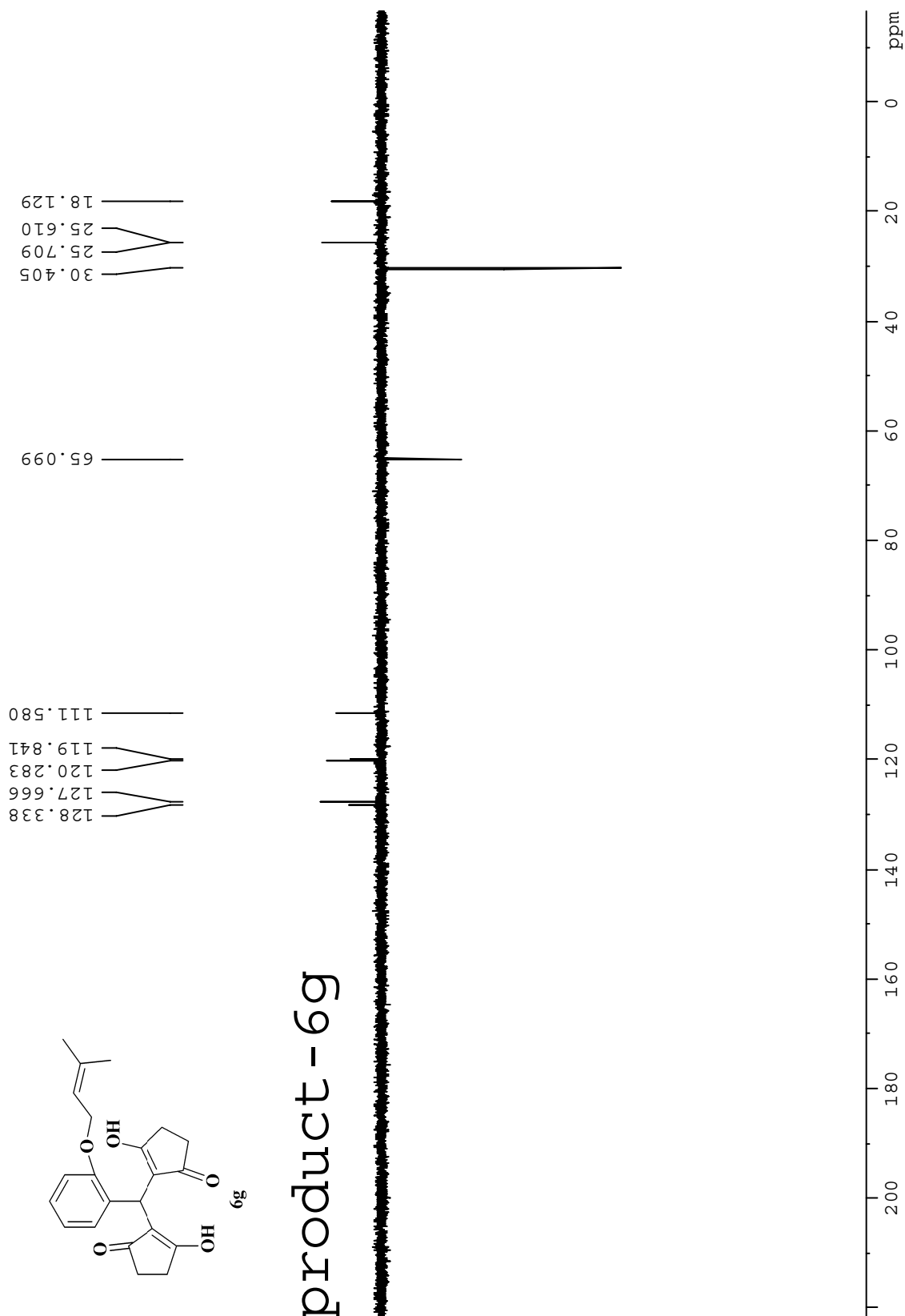

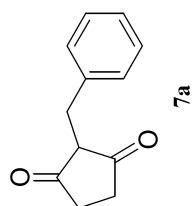

# product - 7a

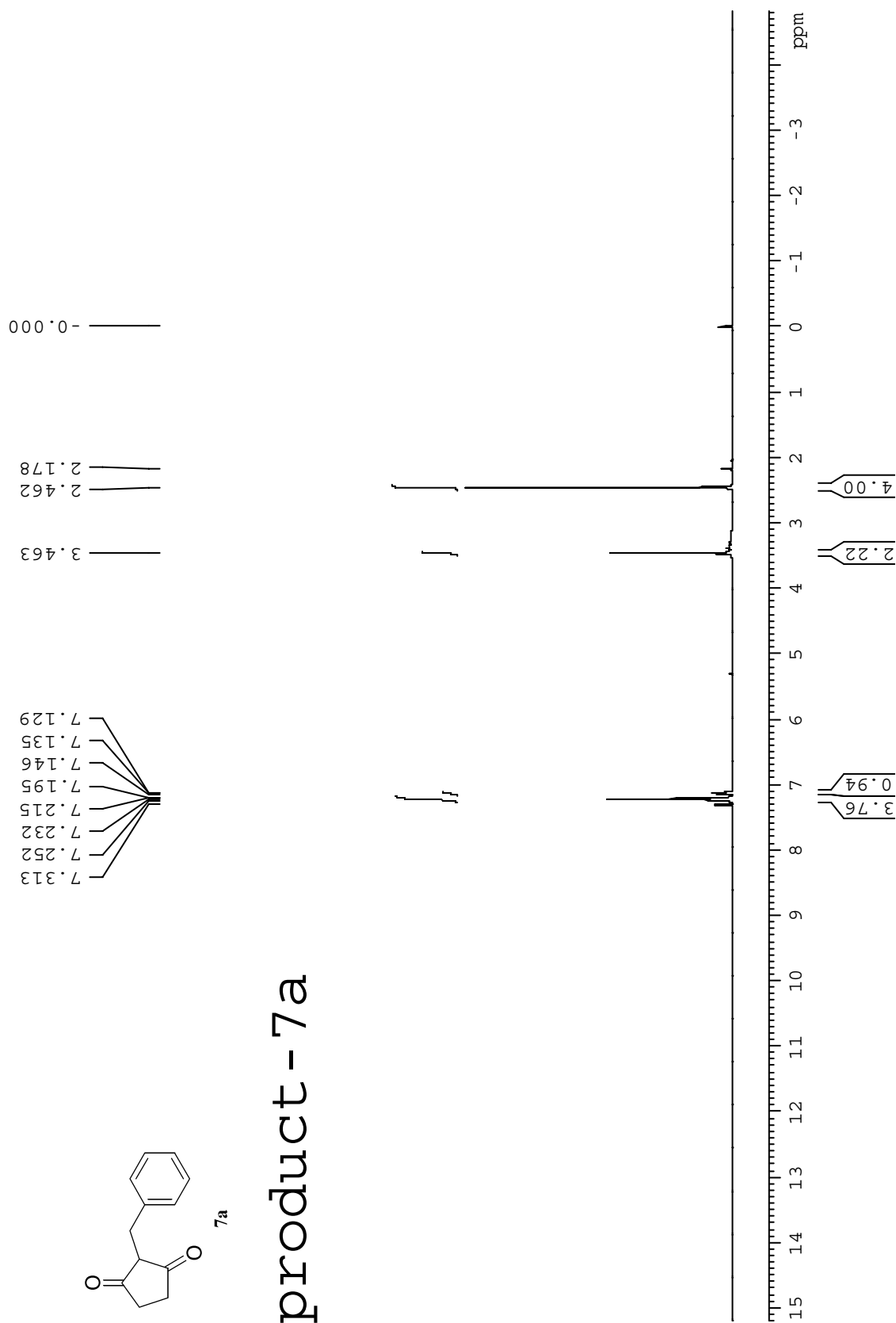

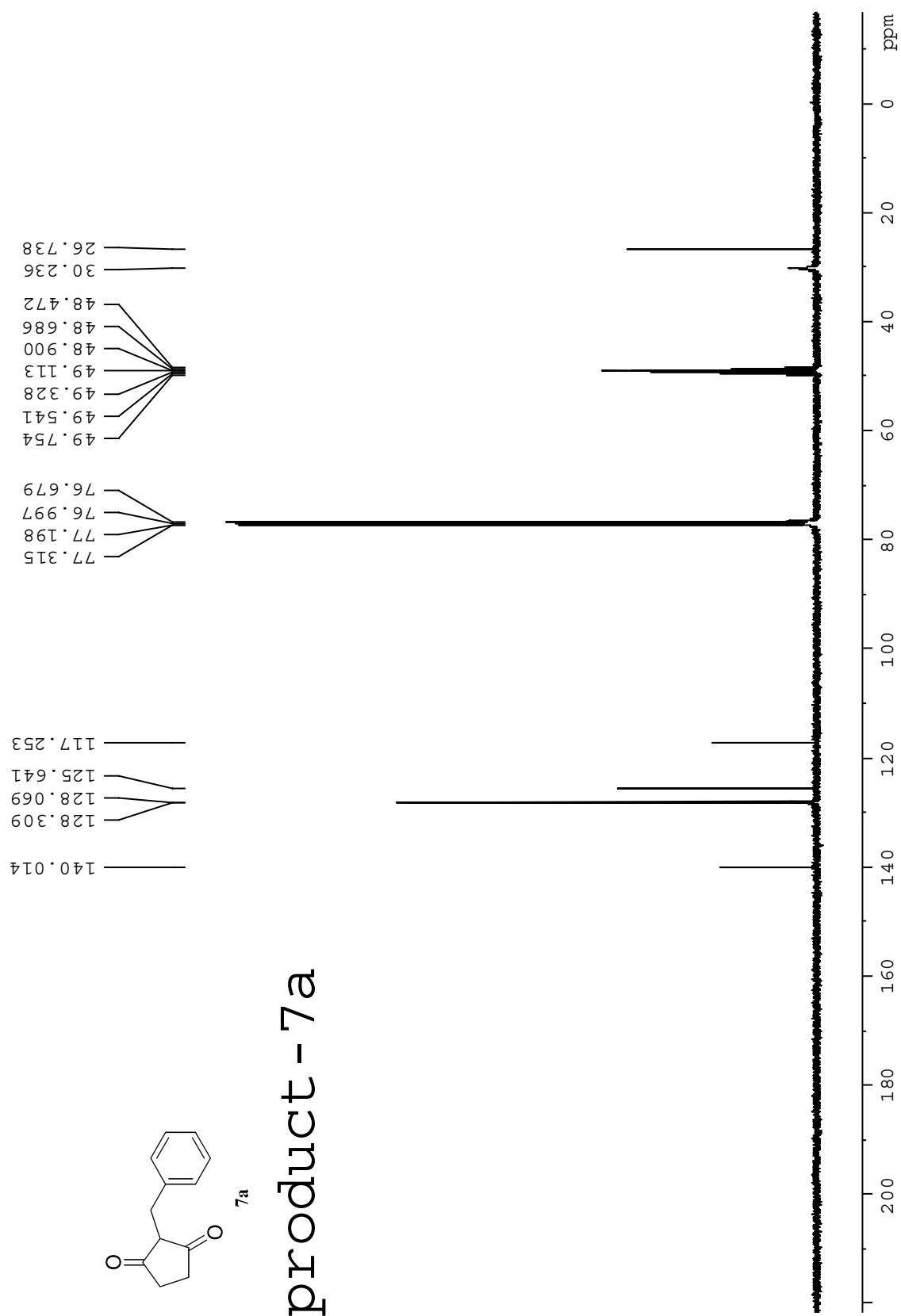

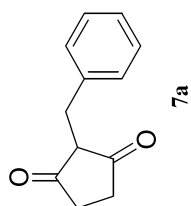

product - 7a

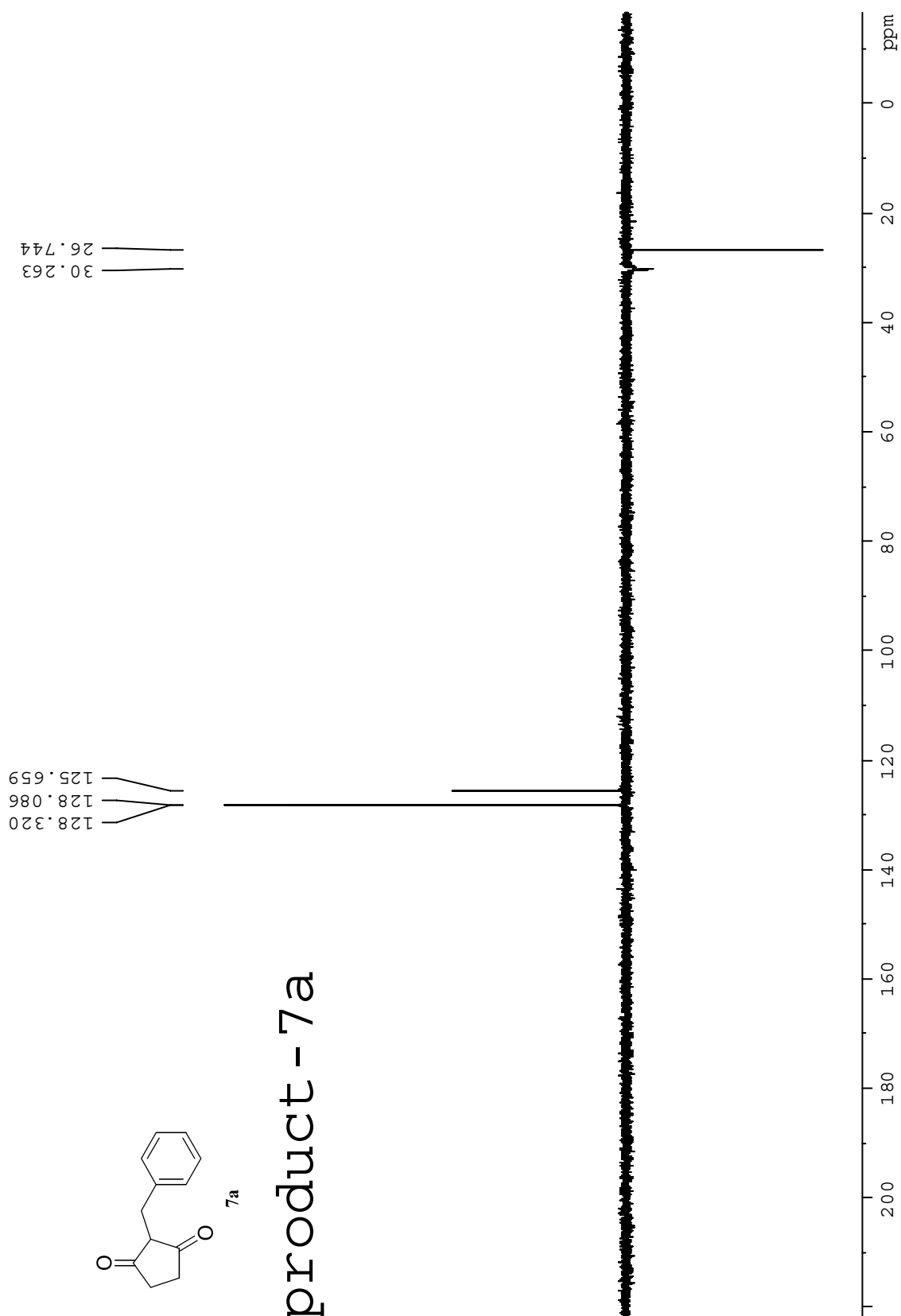

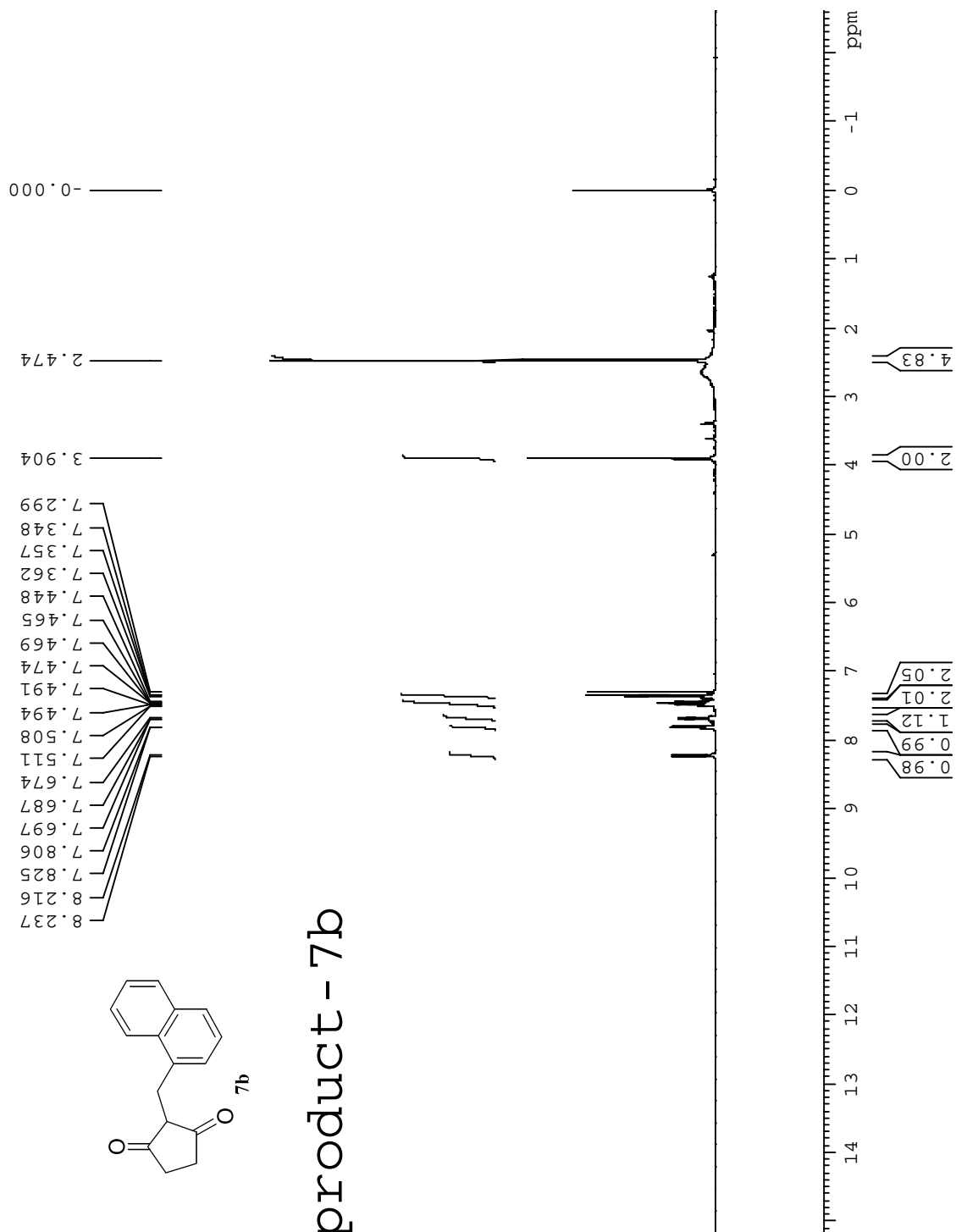

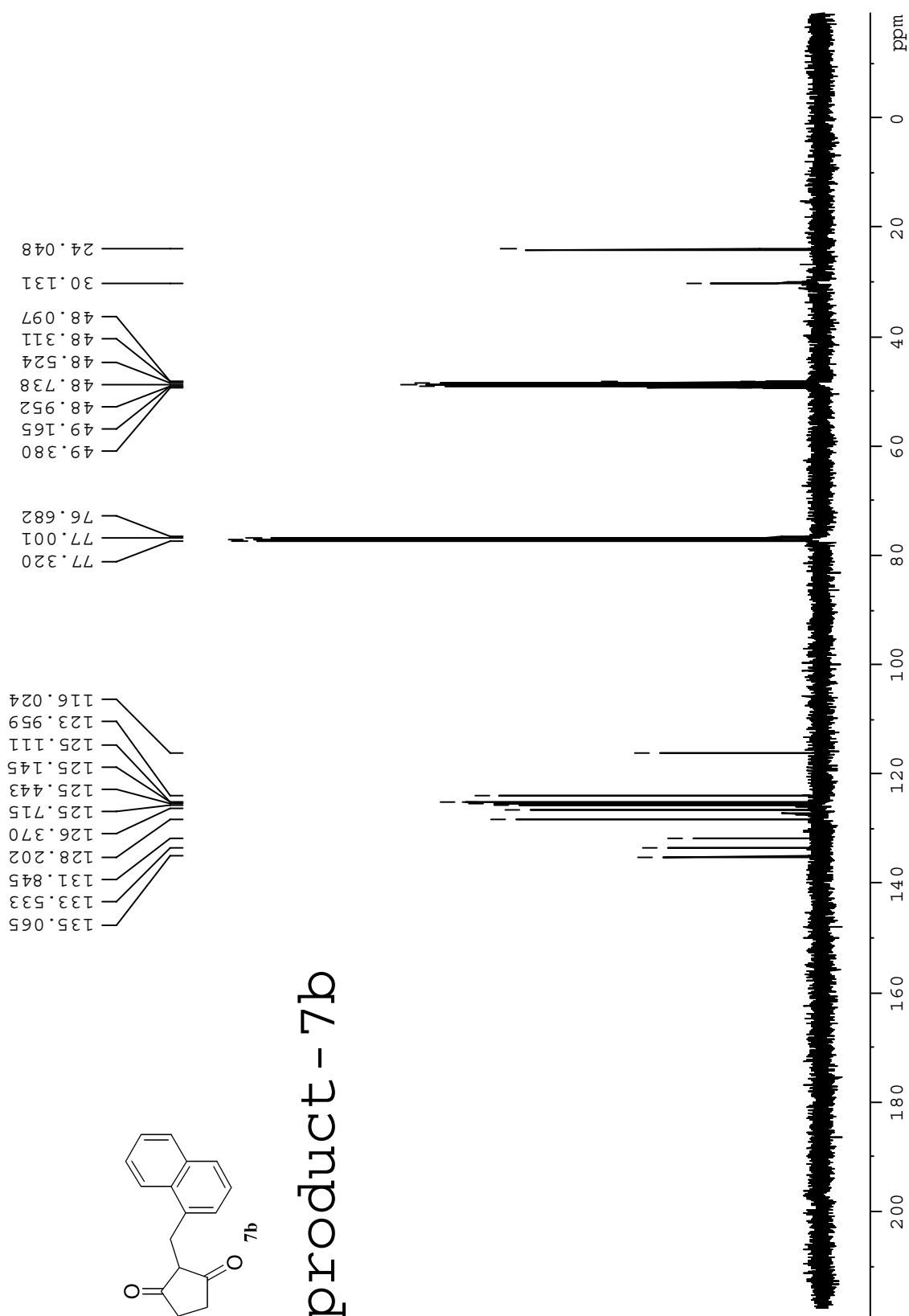

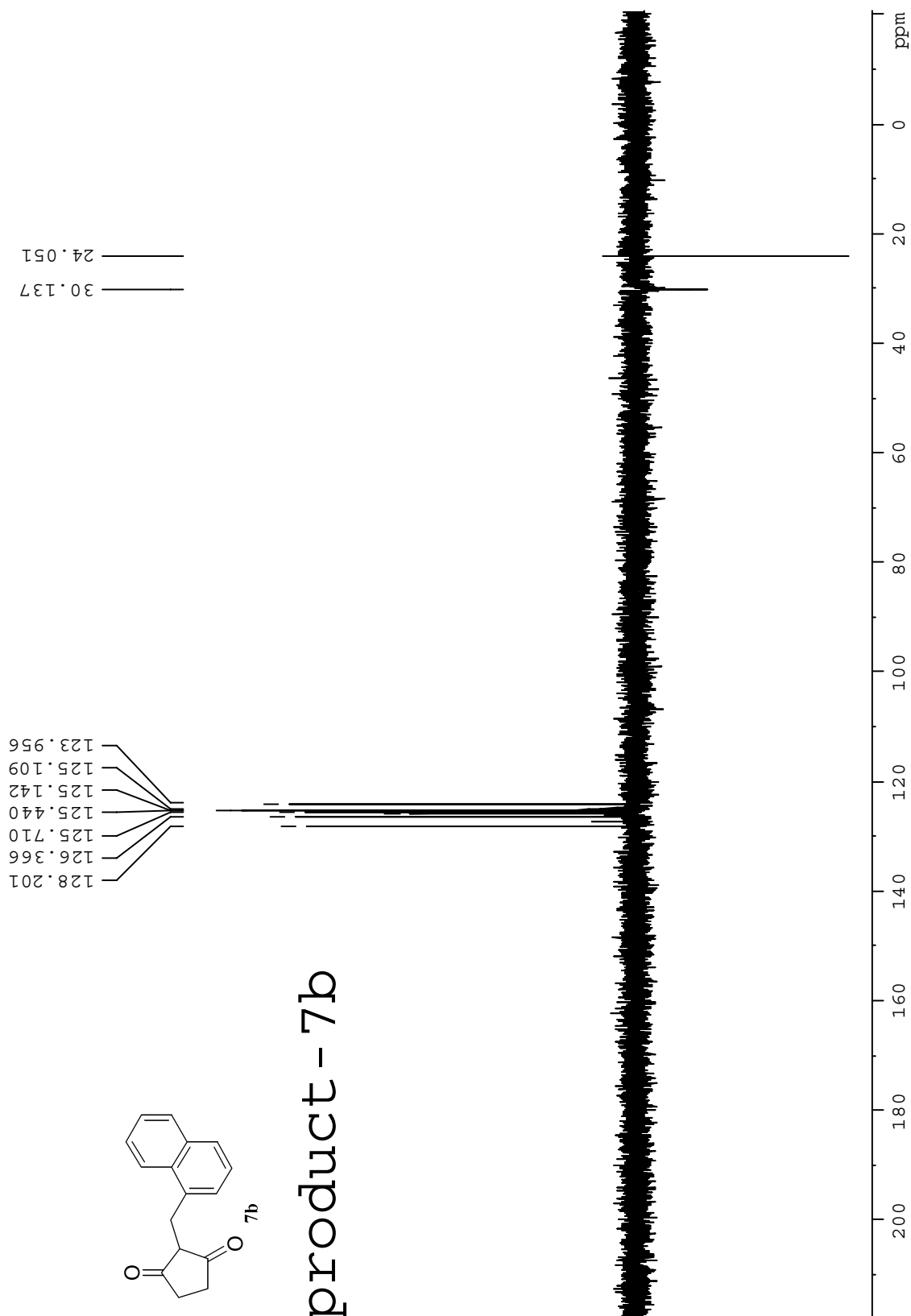

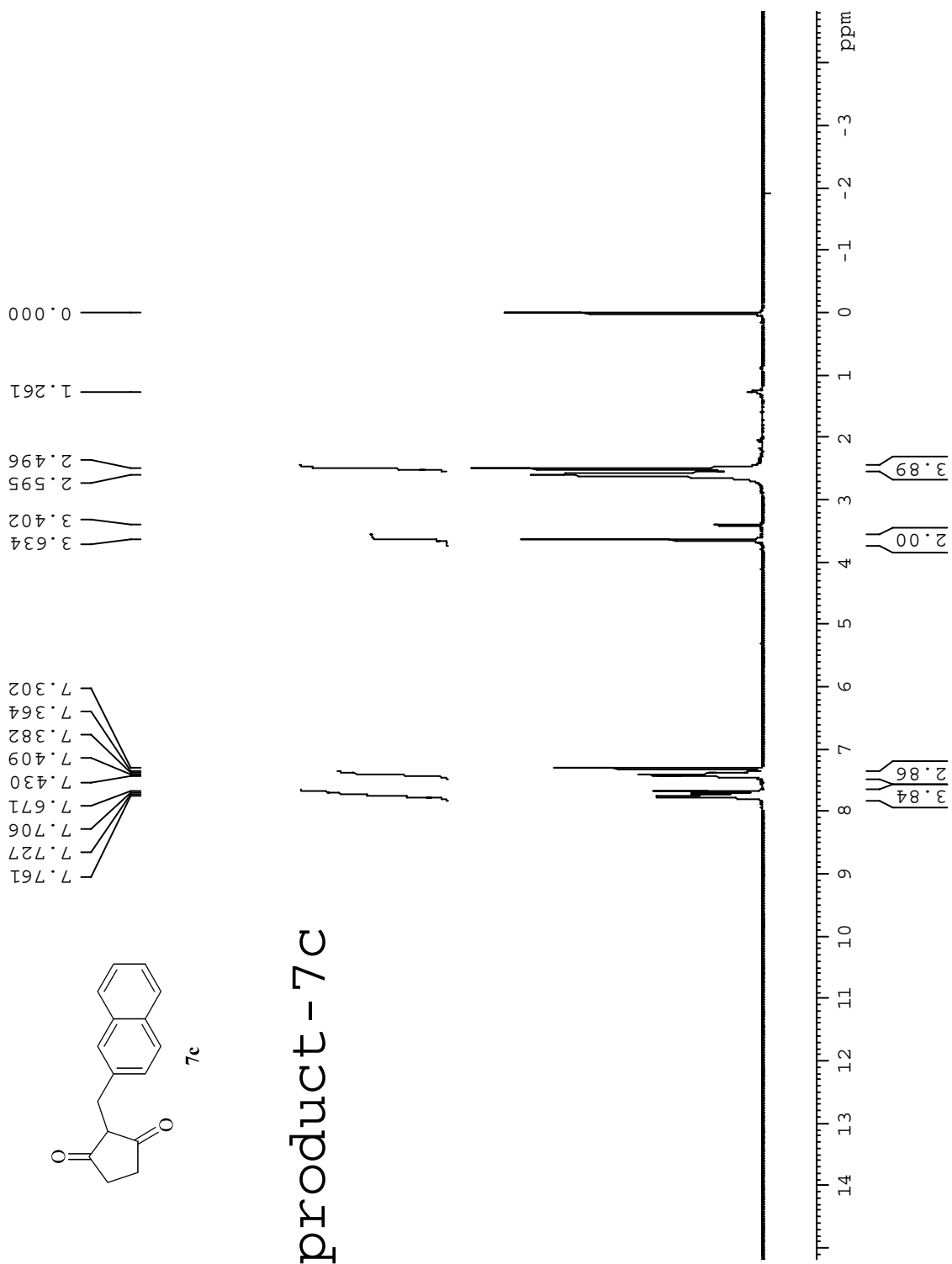



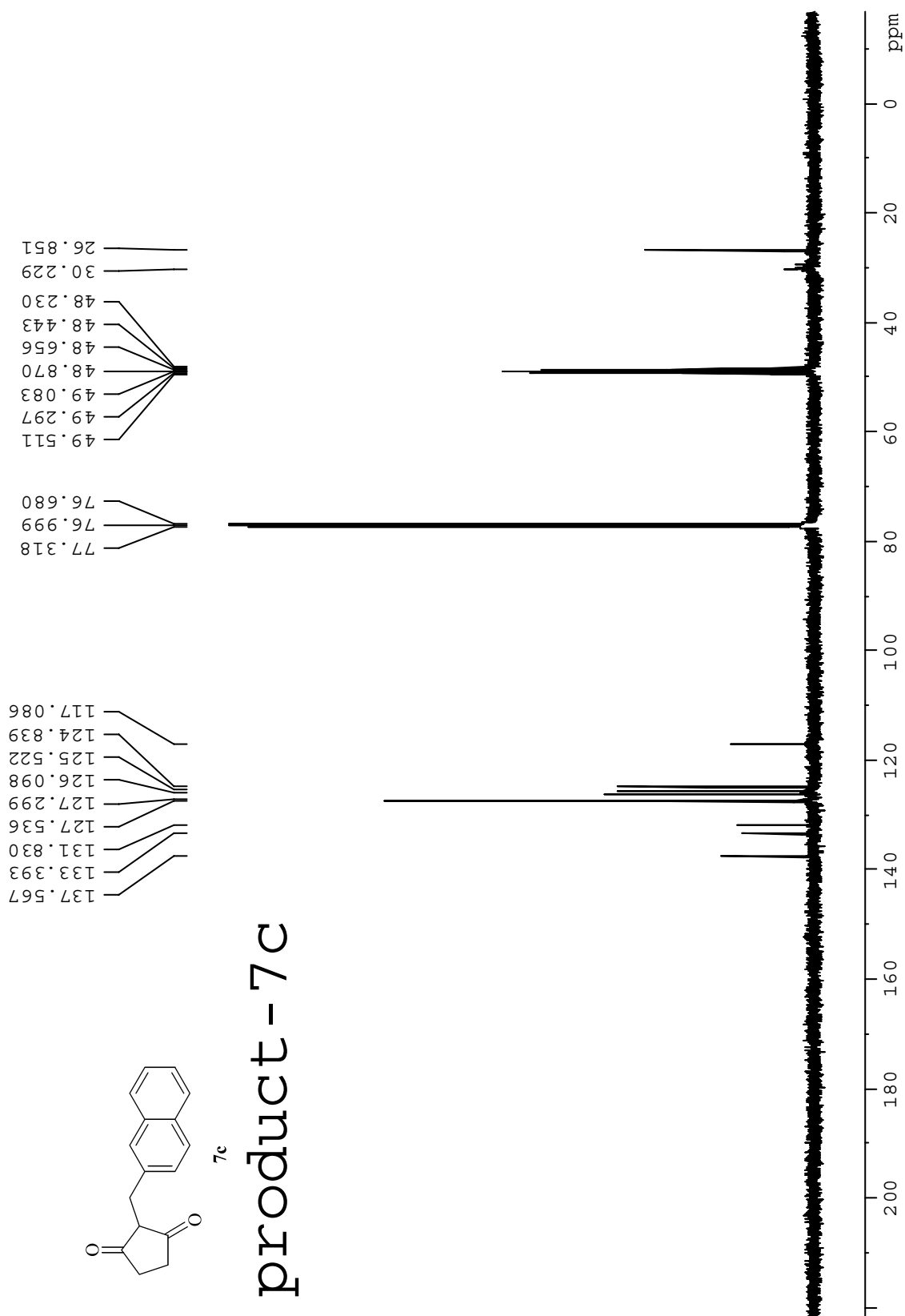

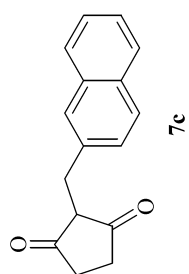

product - 7c

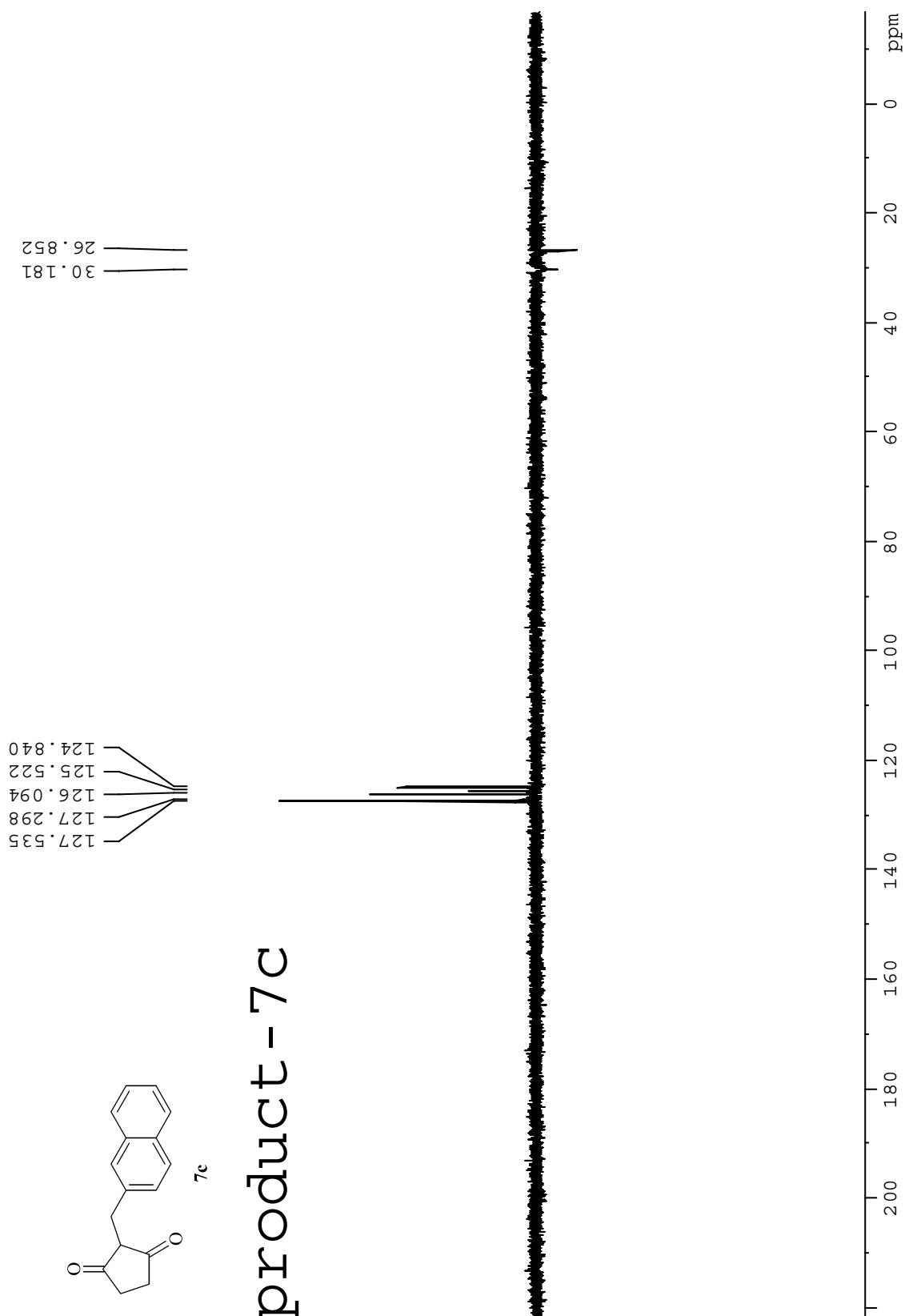

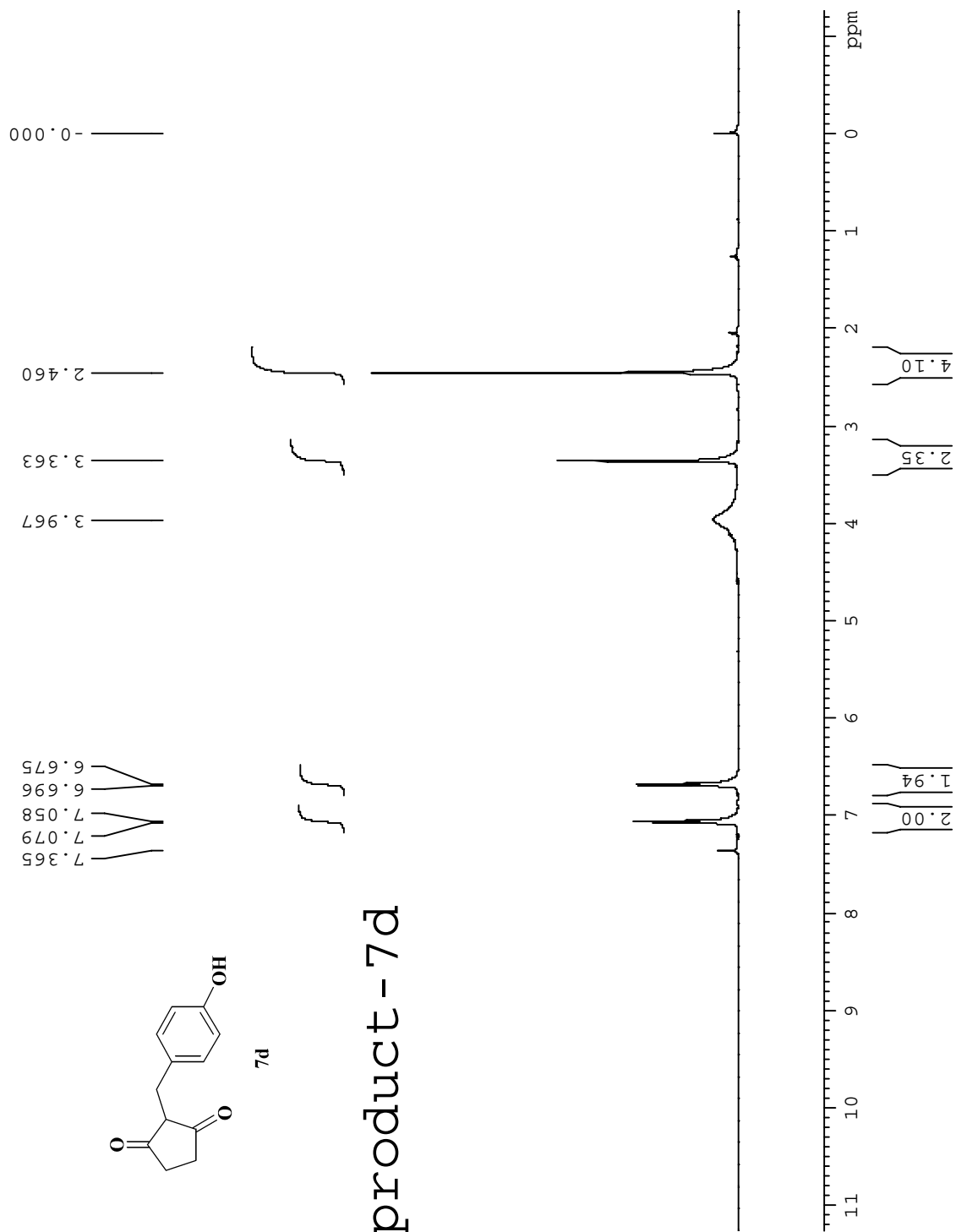

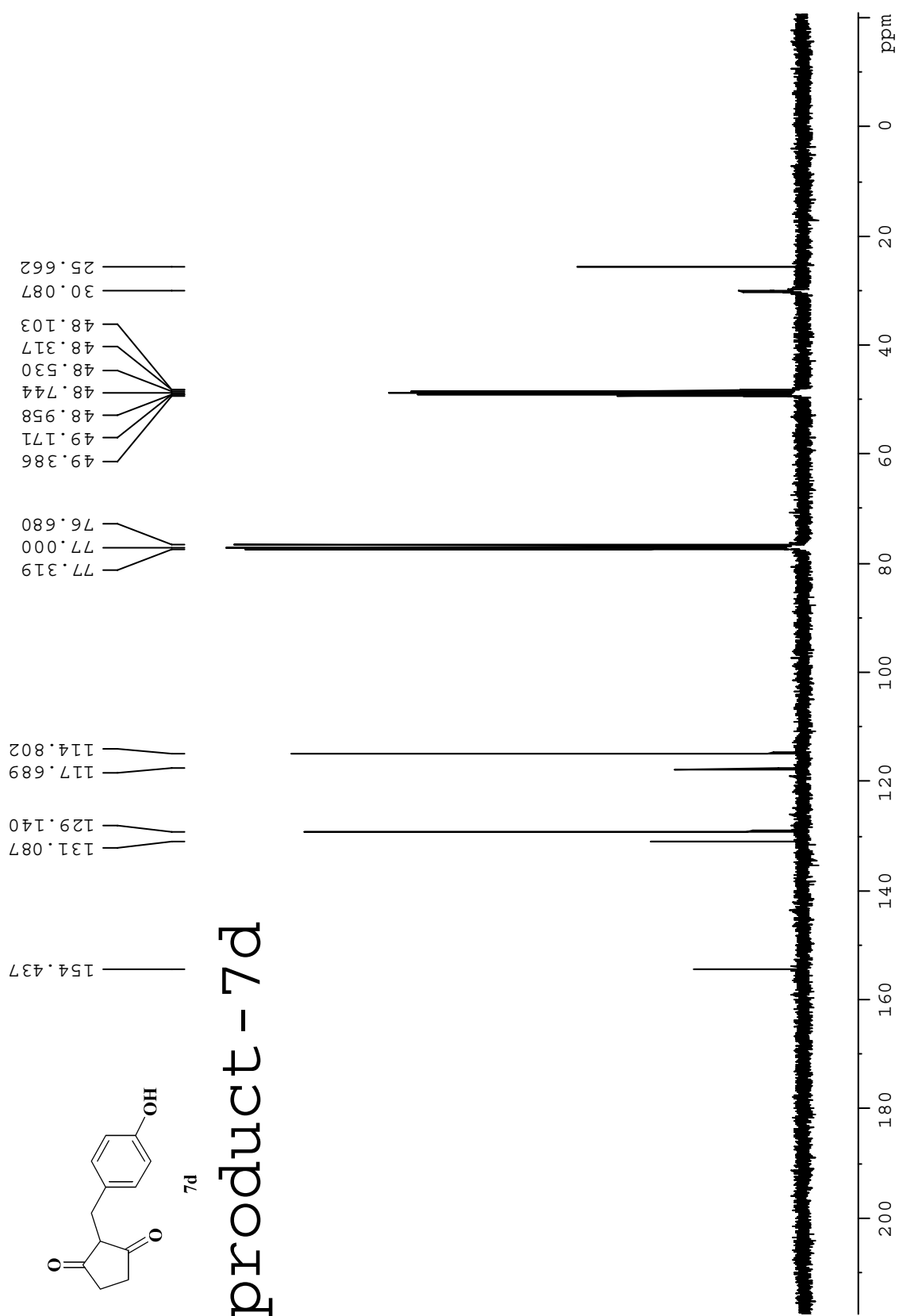

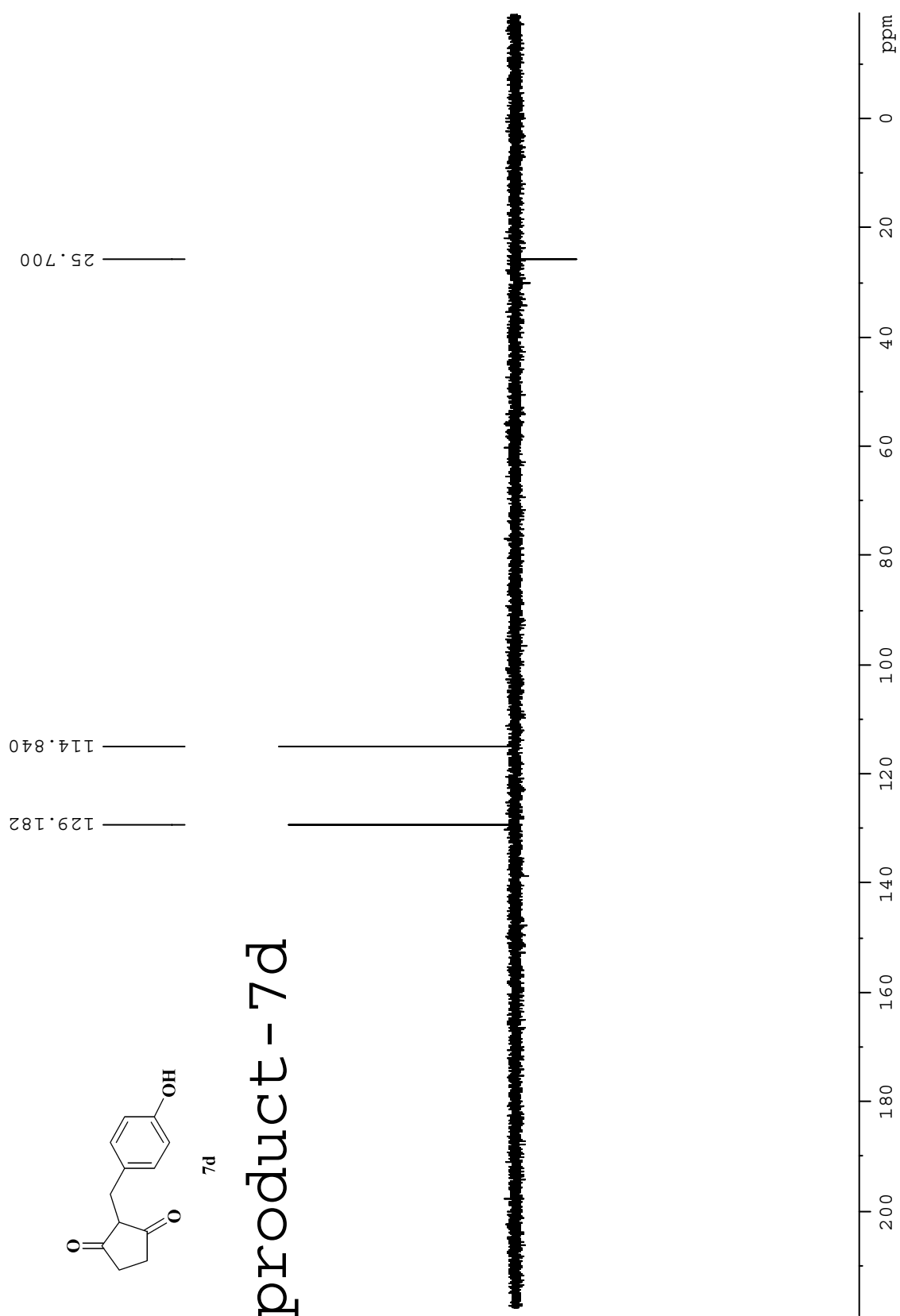

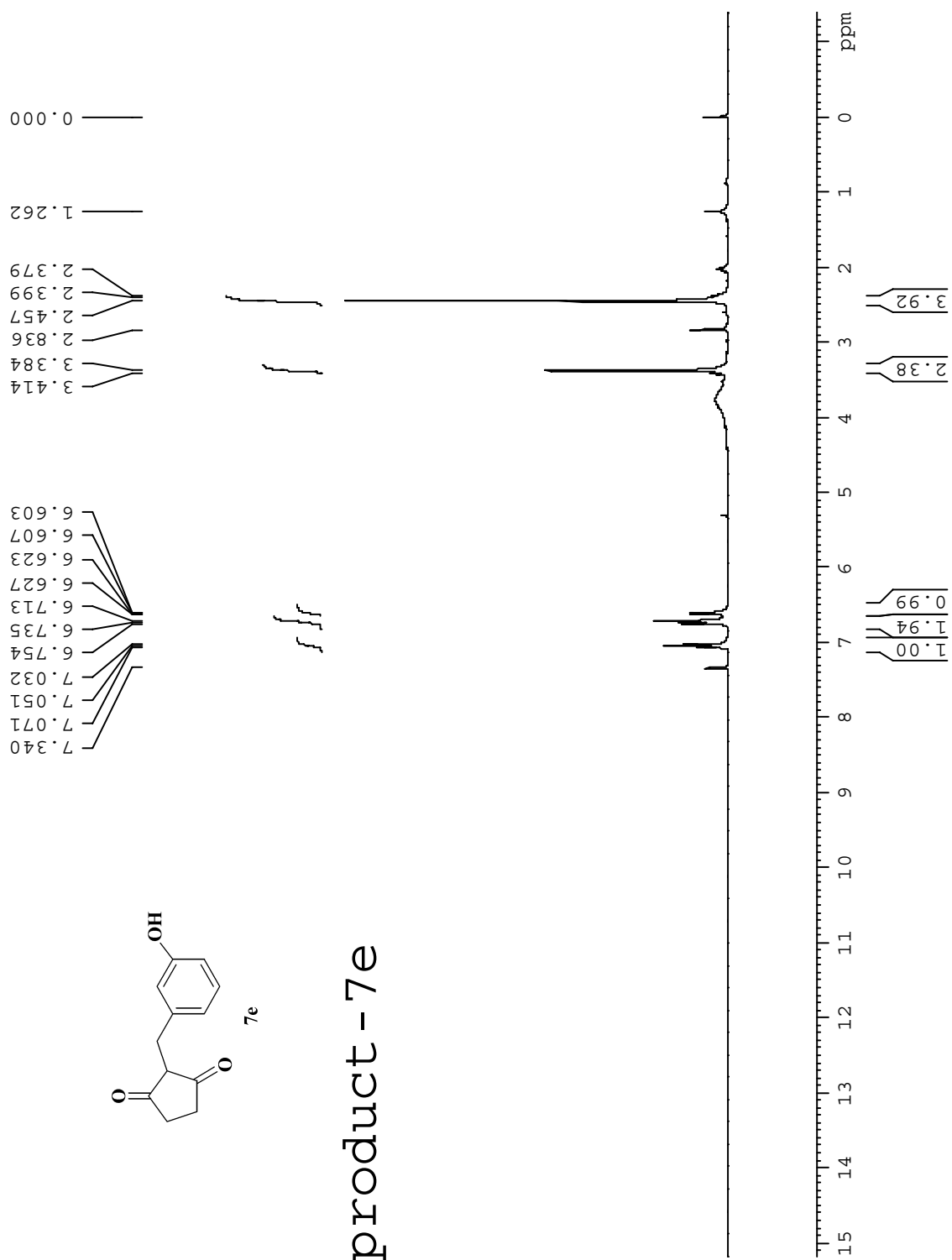

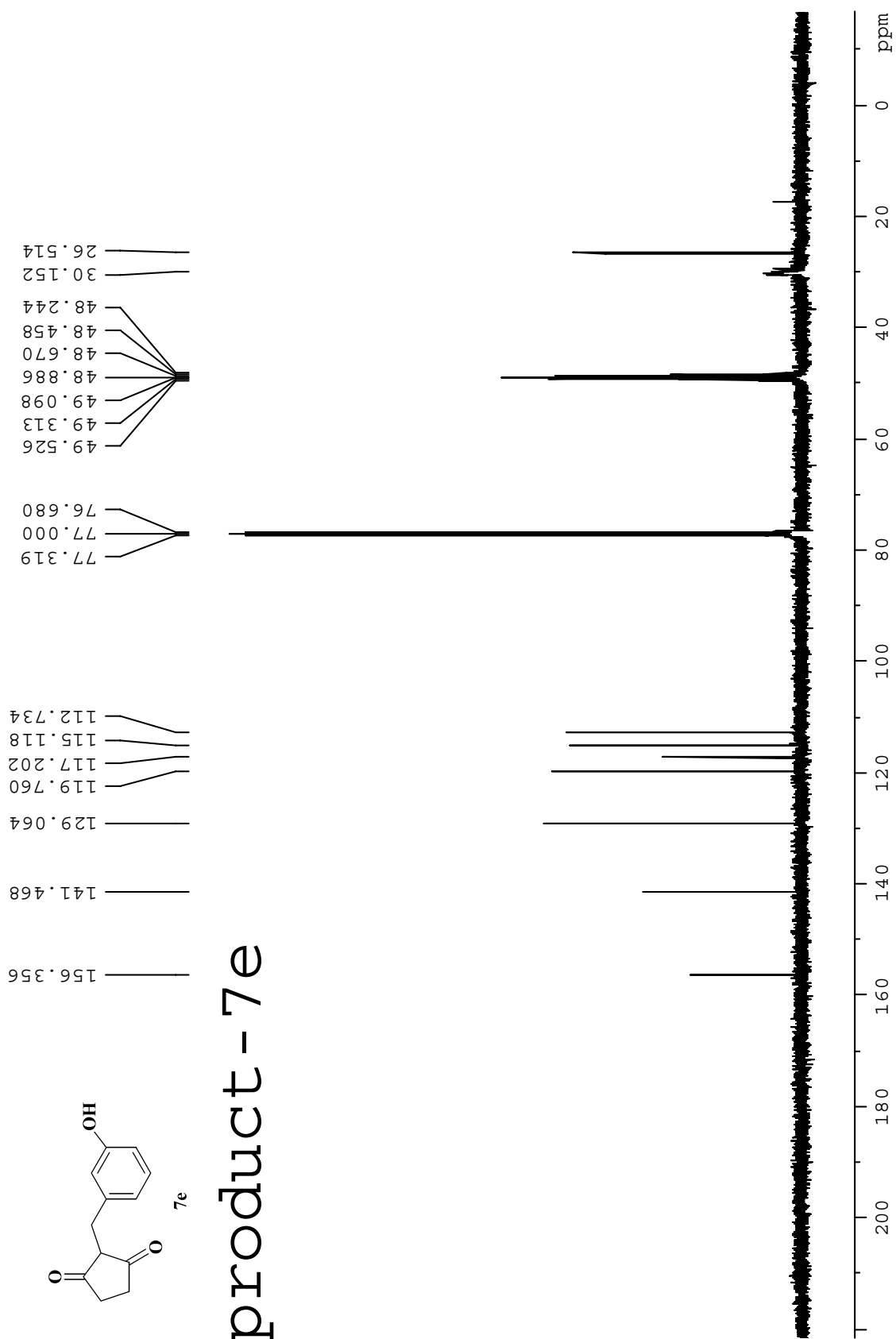

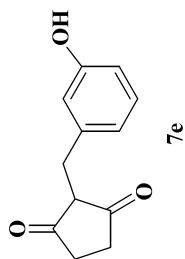

# product - 7e

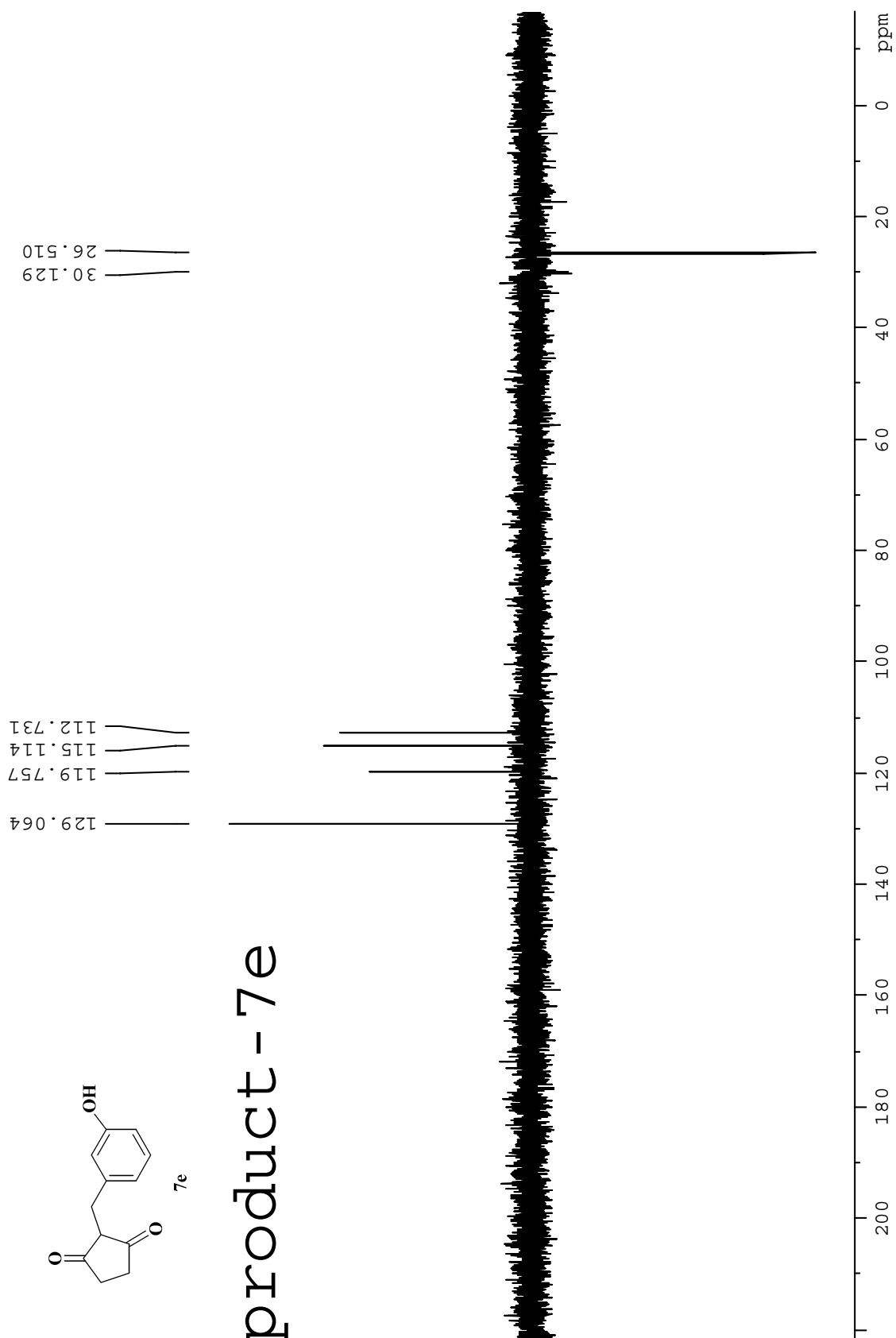



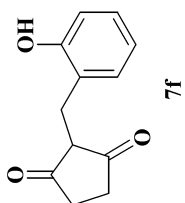
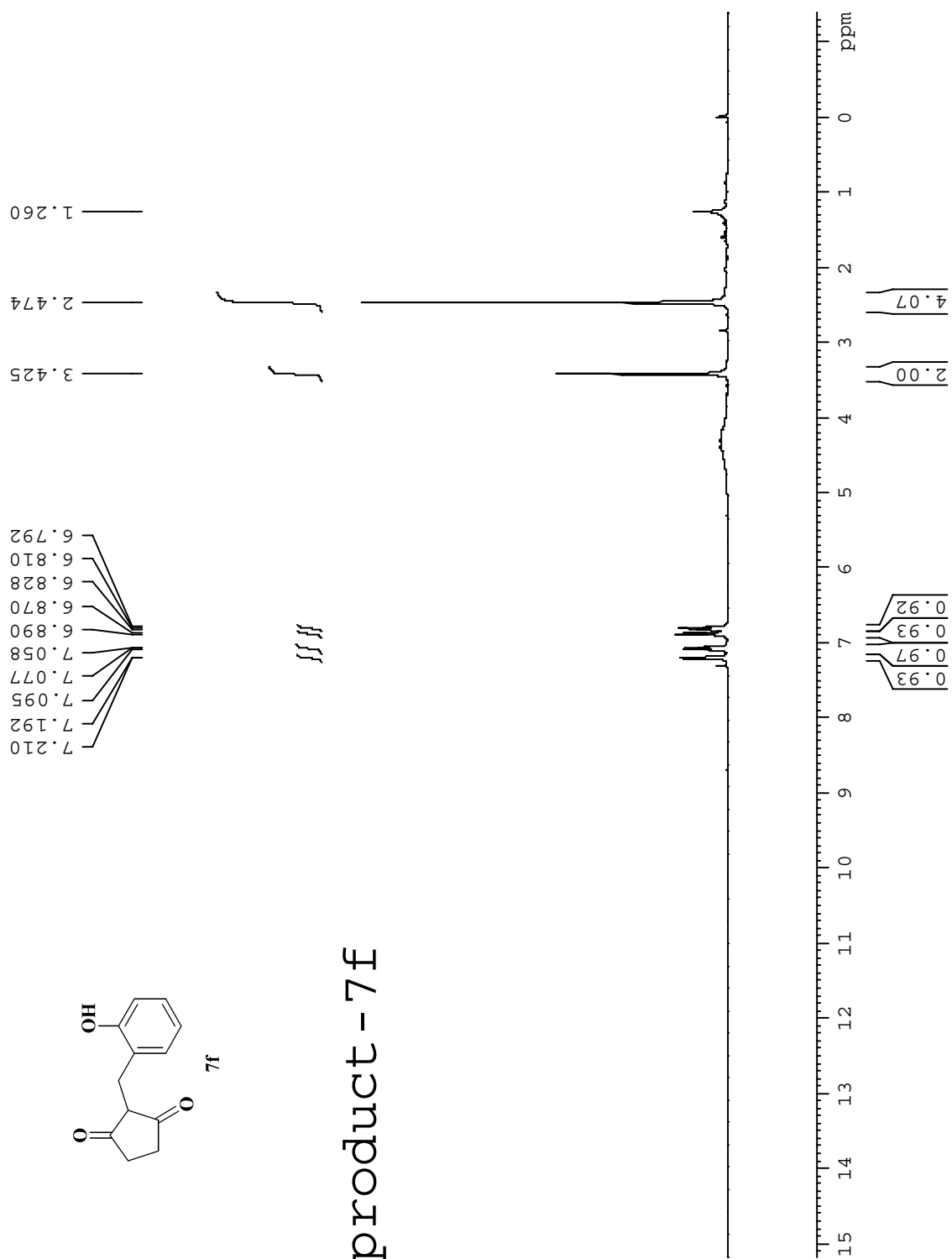

product - 7f

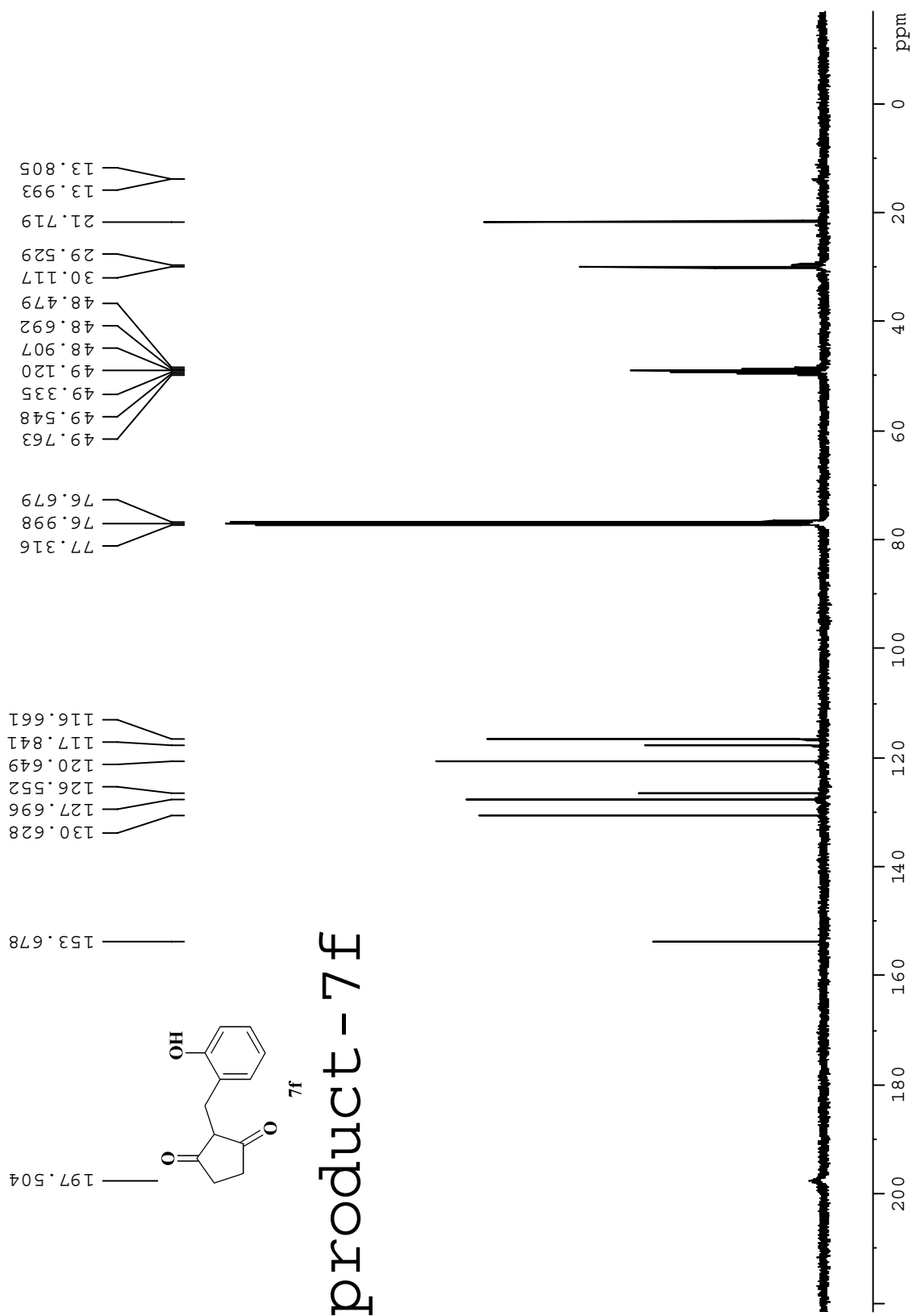

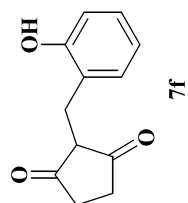

# product - 7f

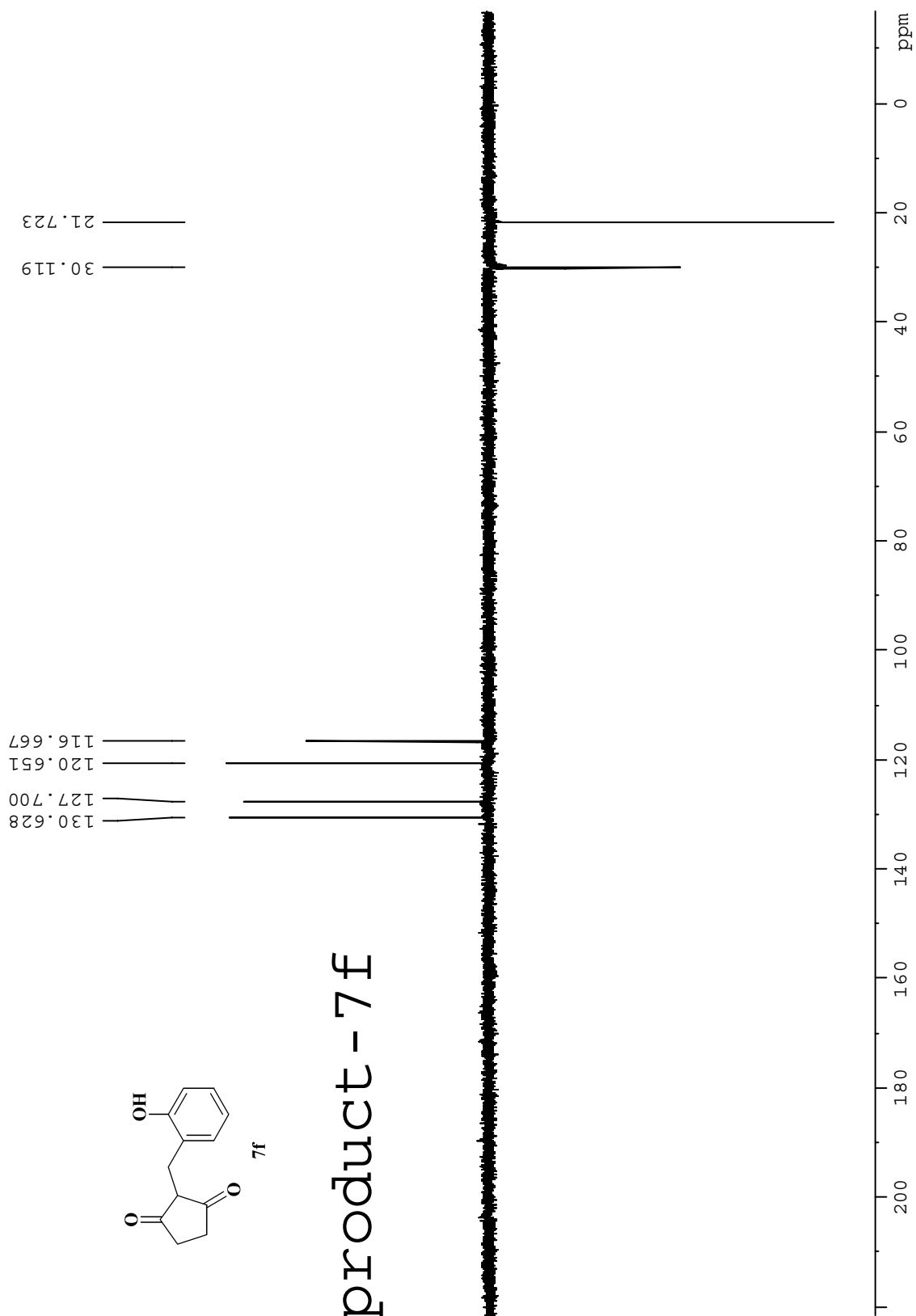

# product - 7g

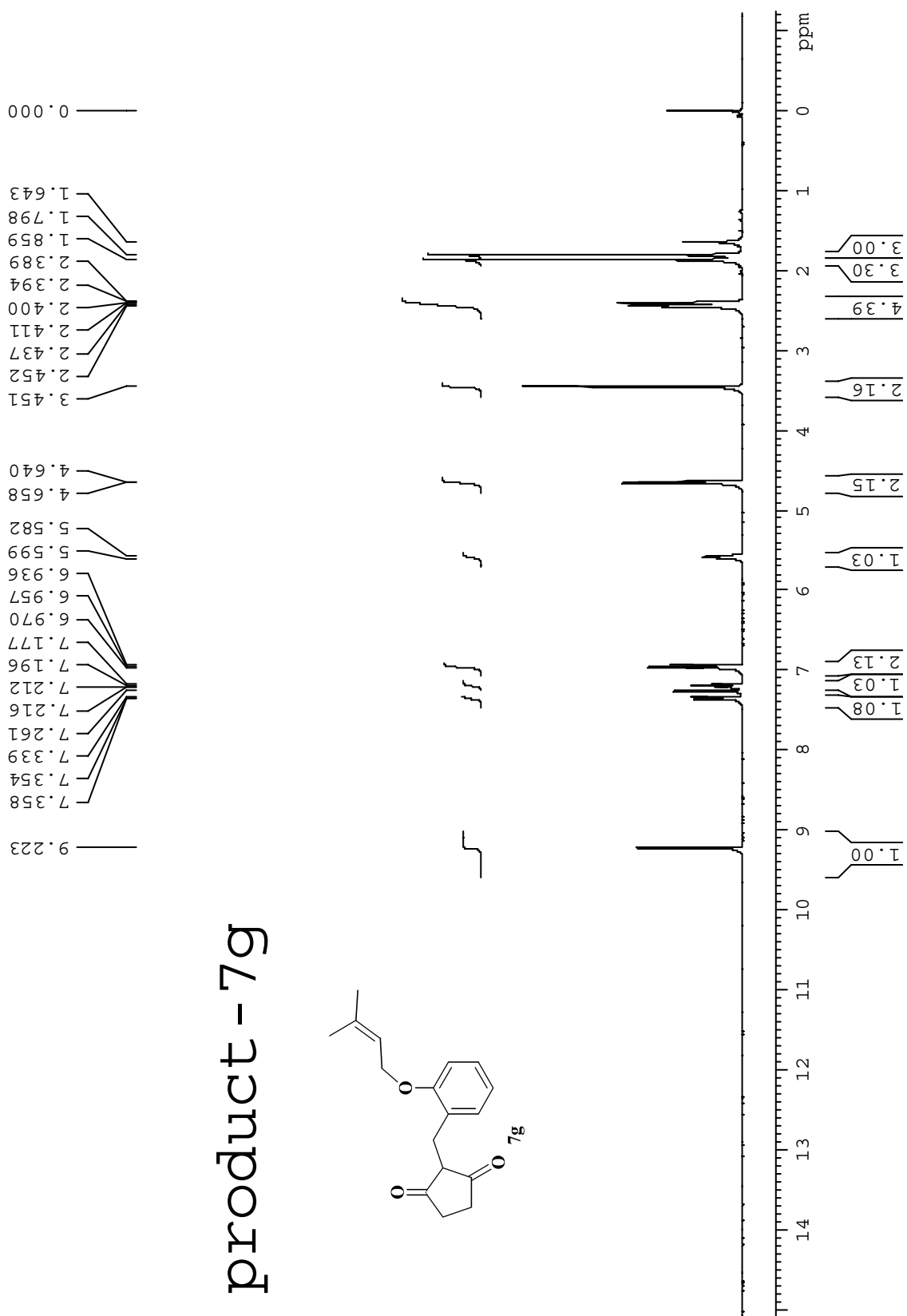
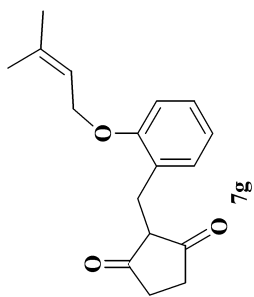

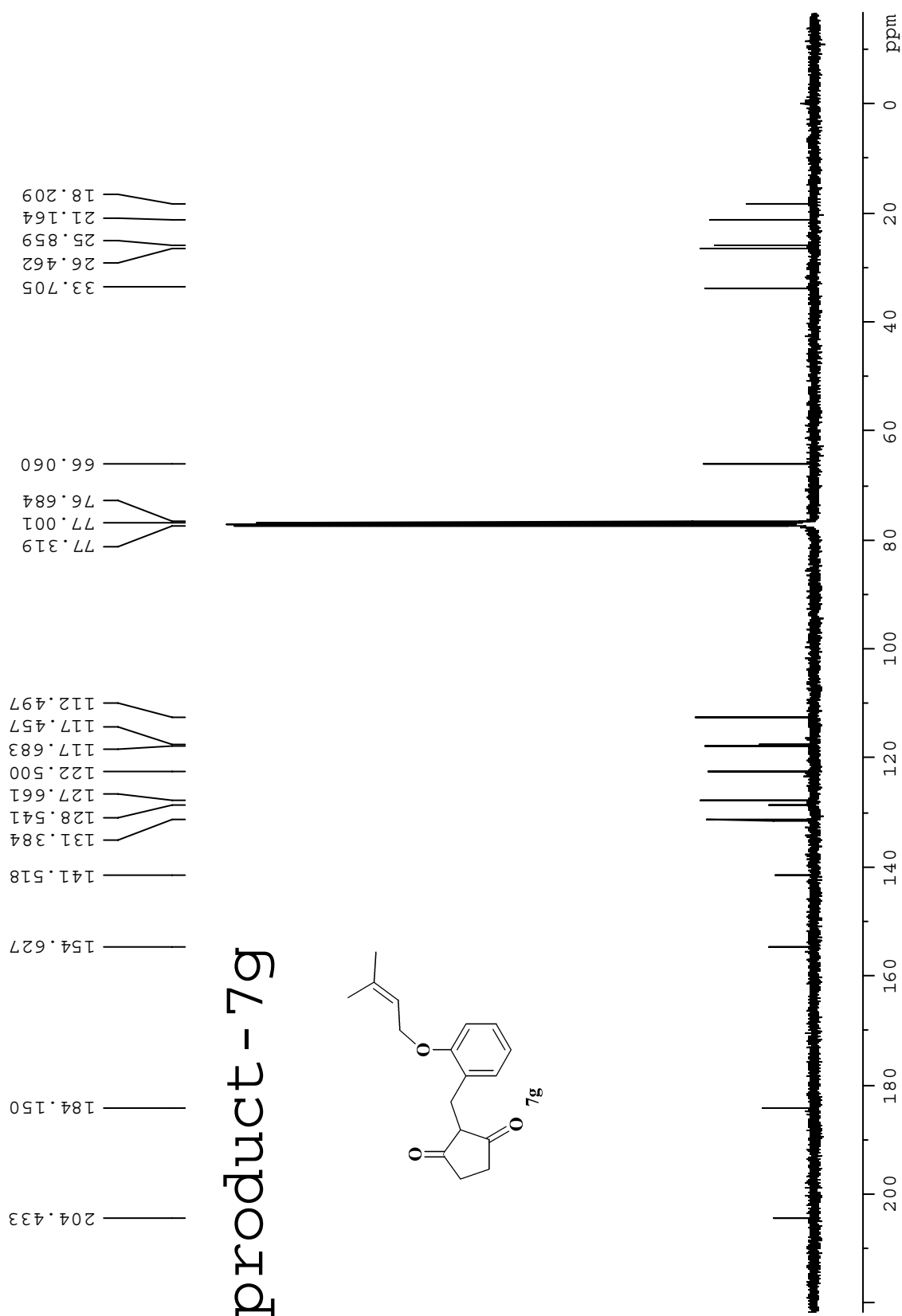

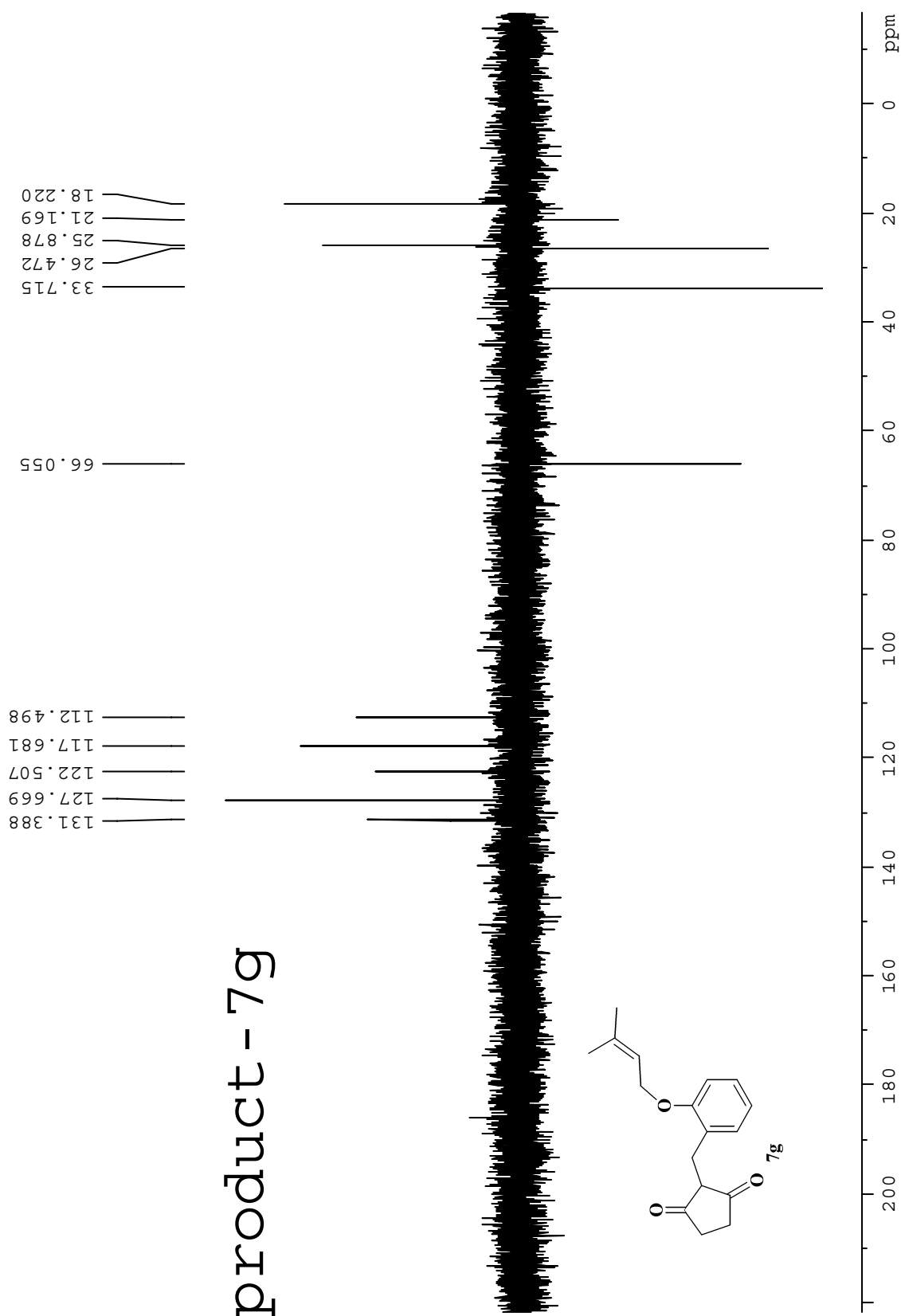

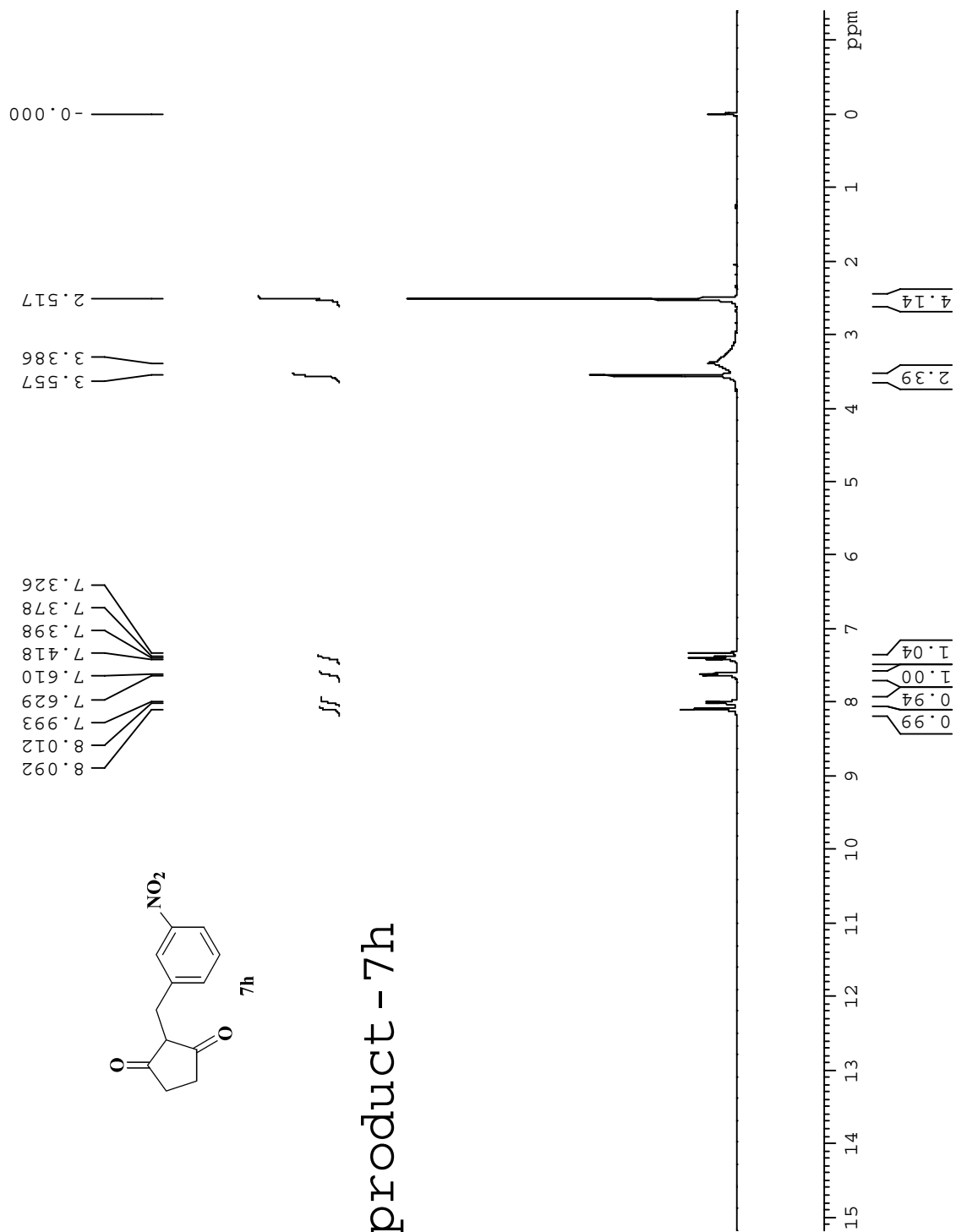

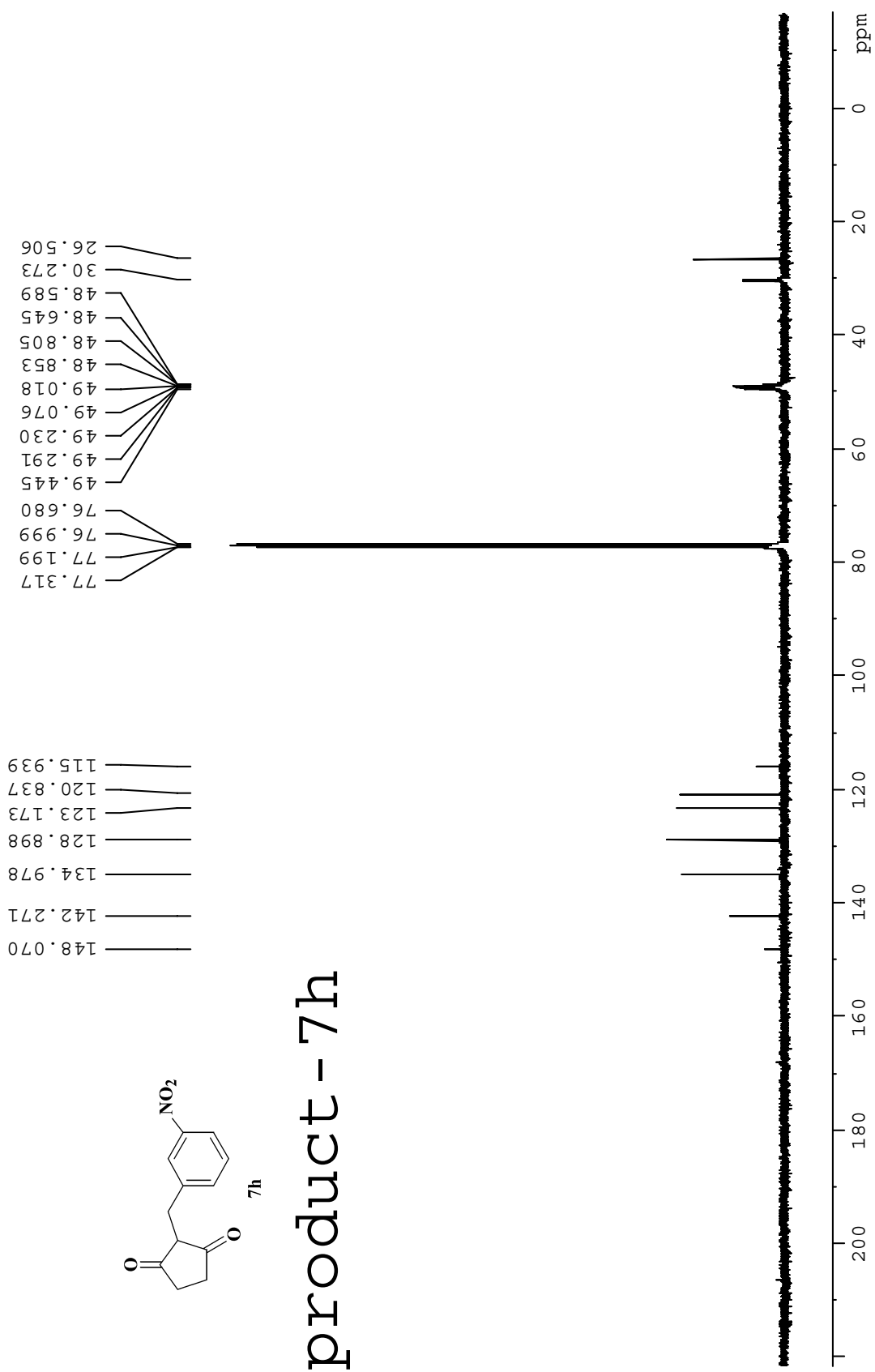



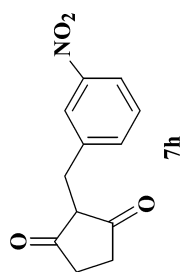

product - 7h

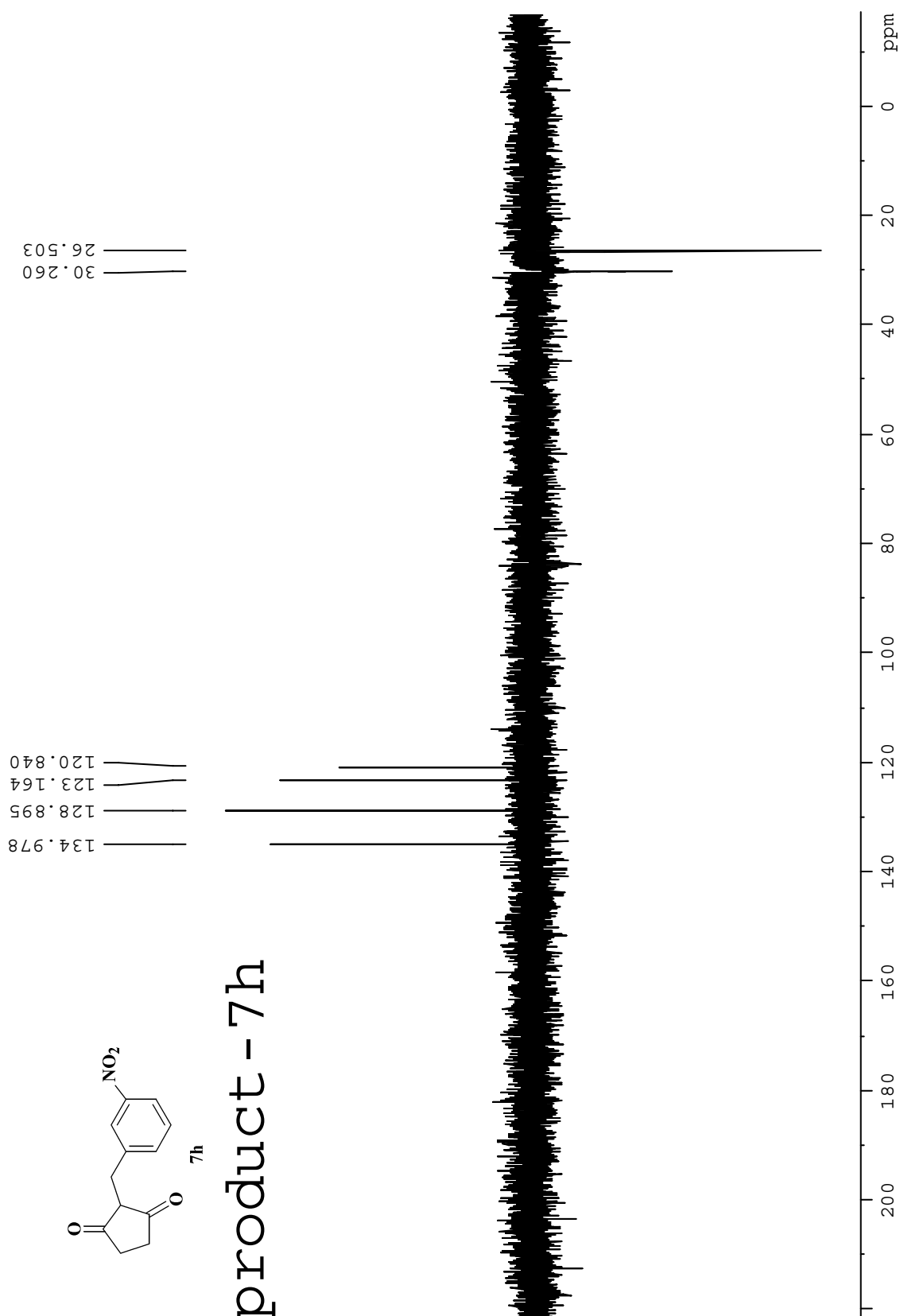

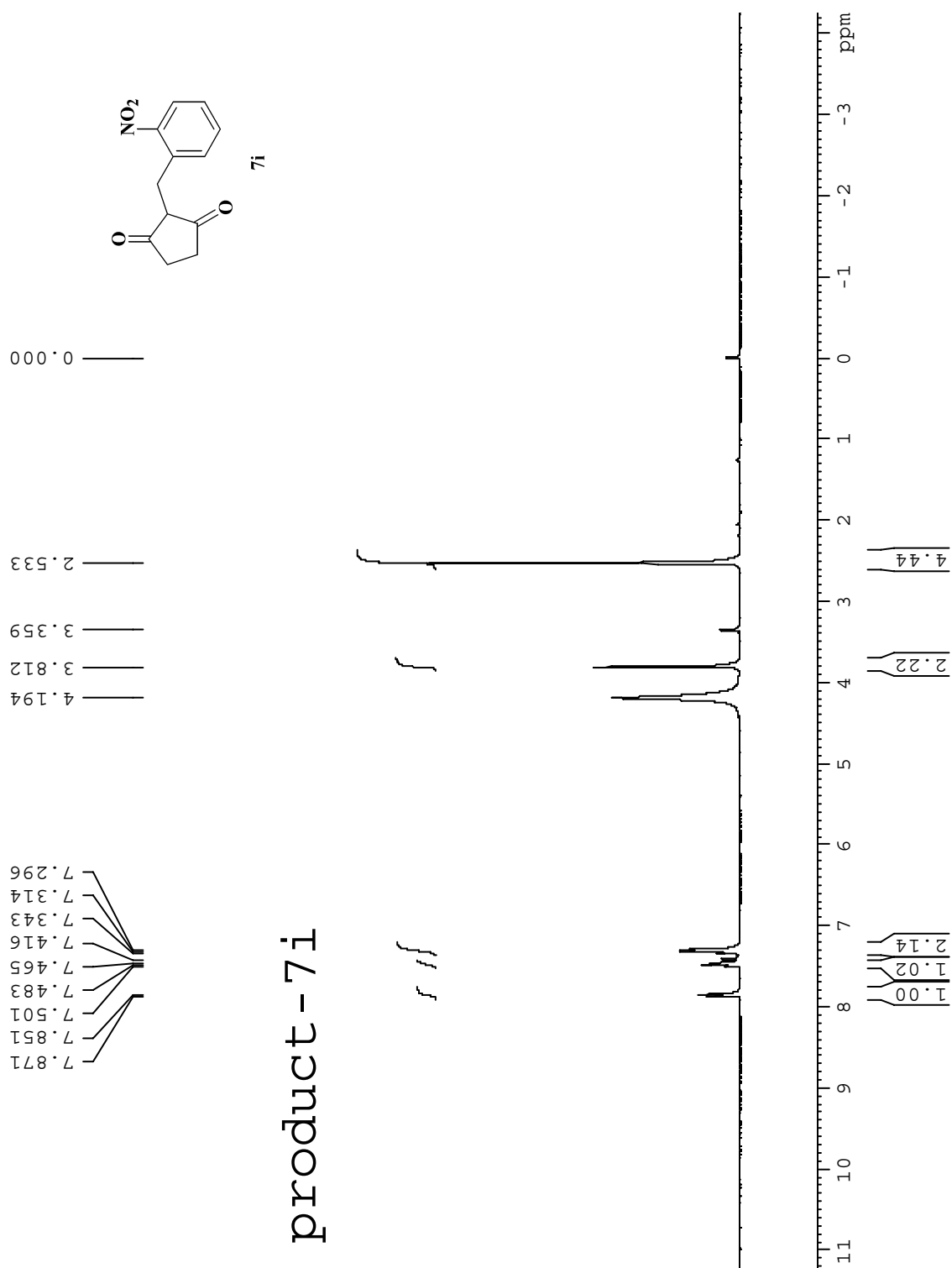

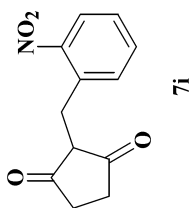
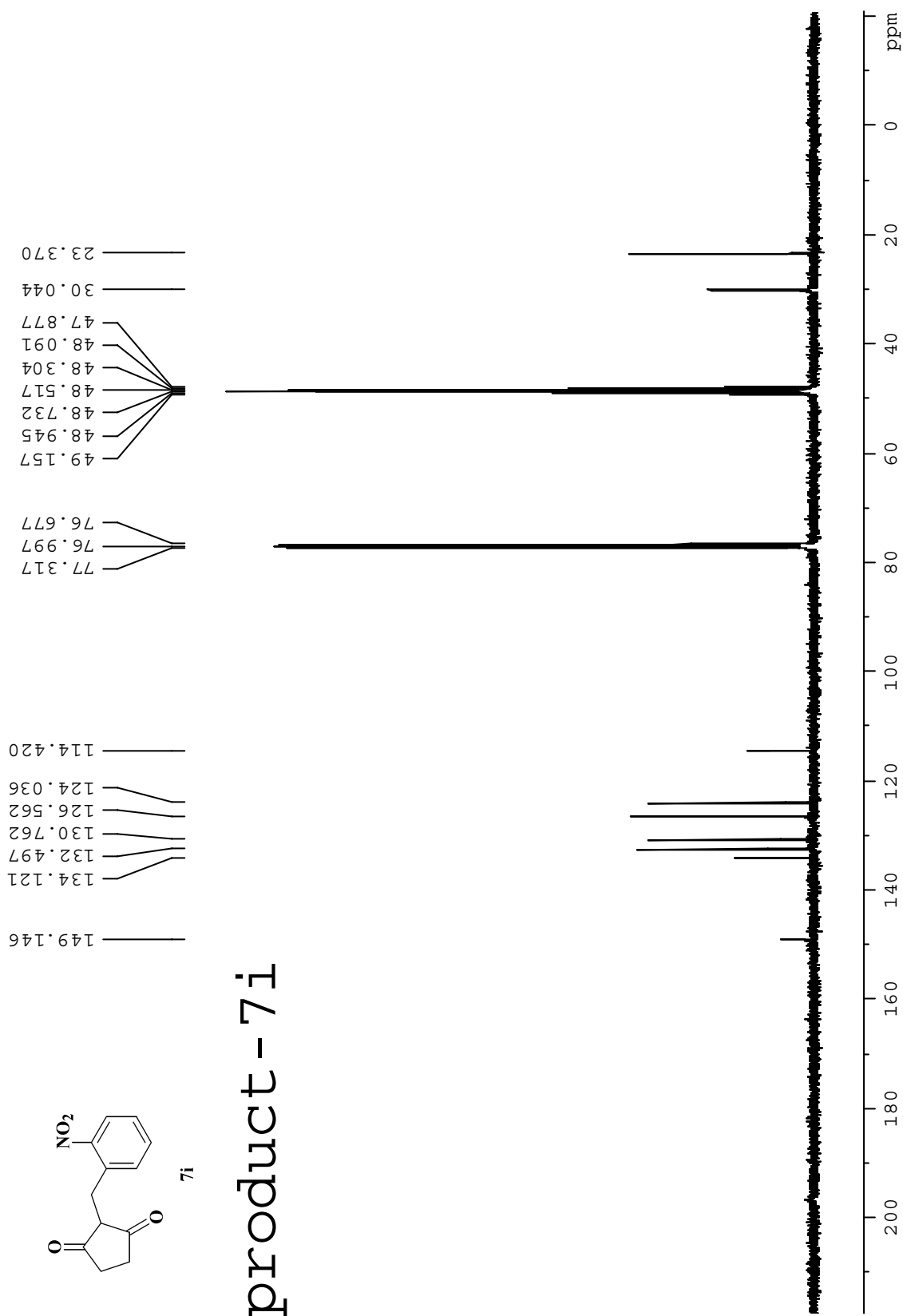

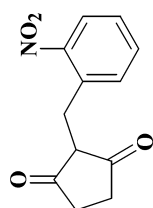

7i

# product-7i

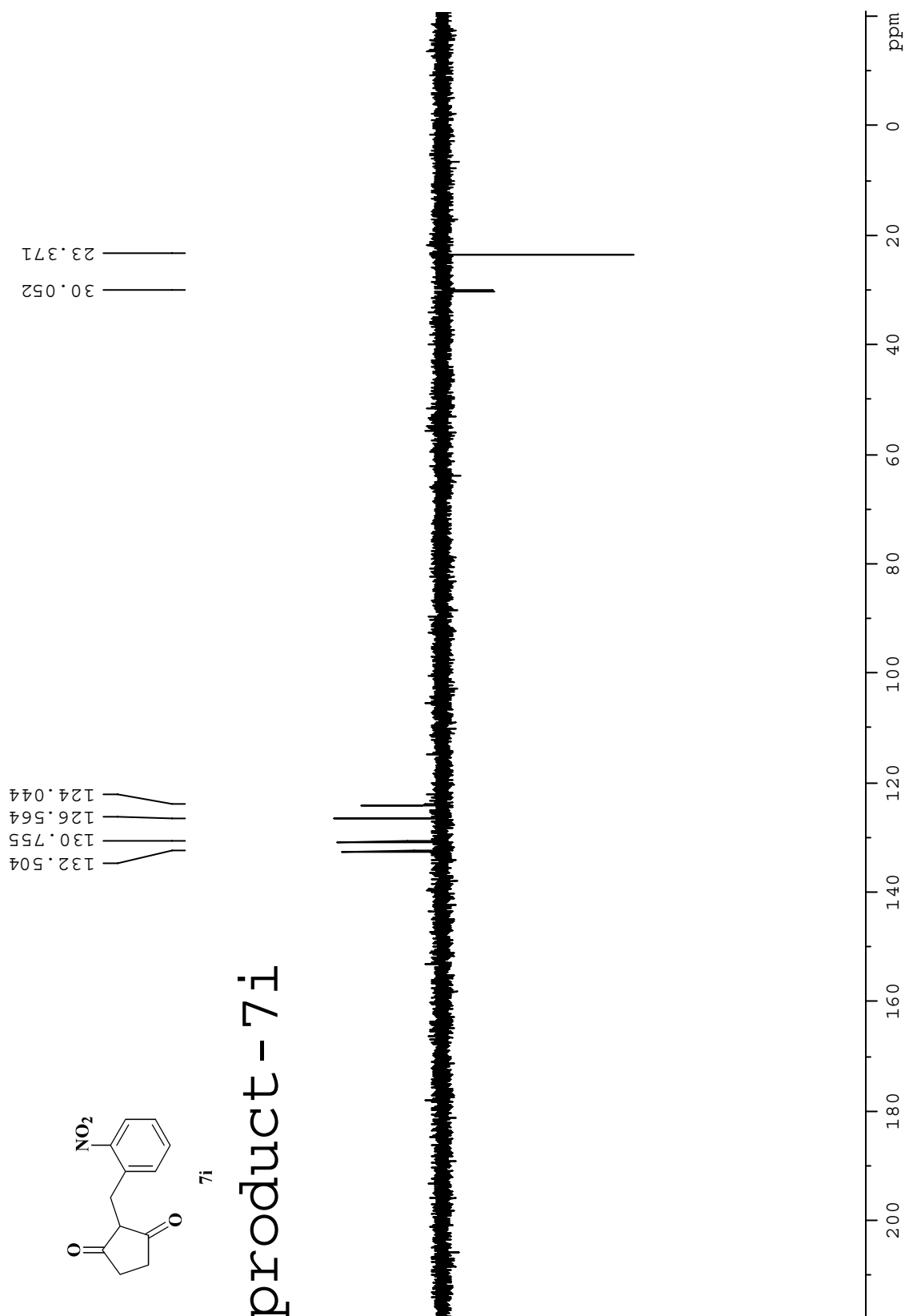

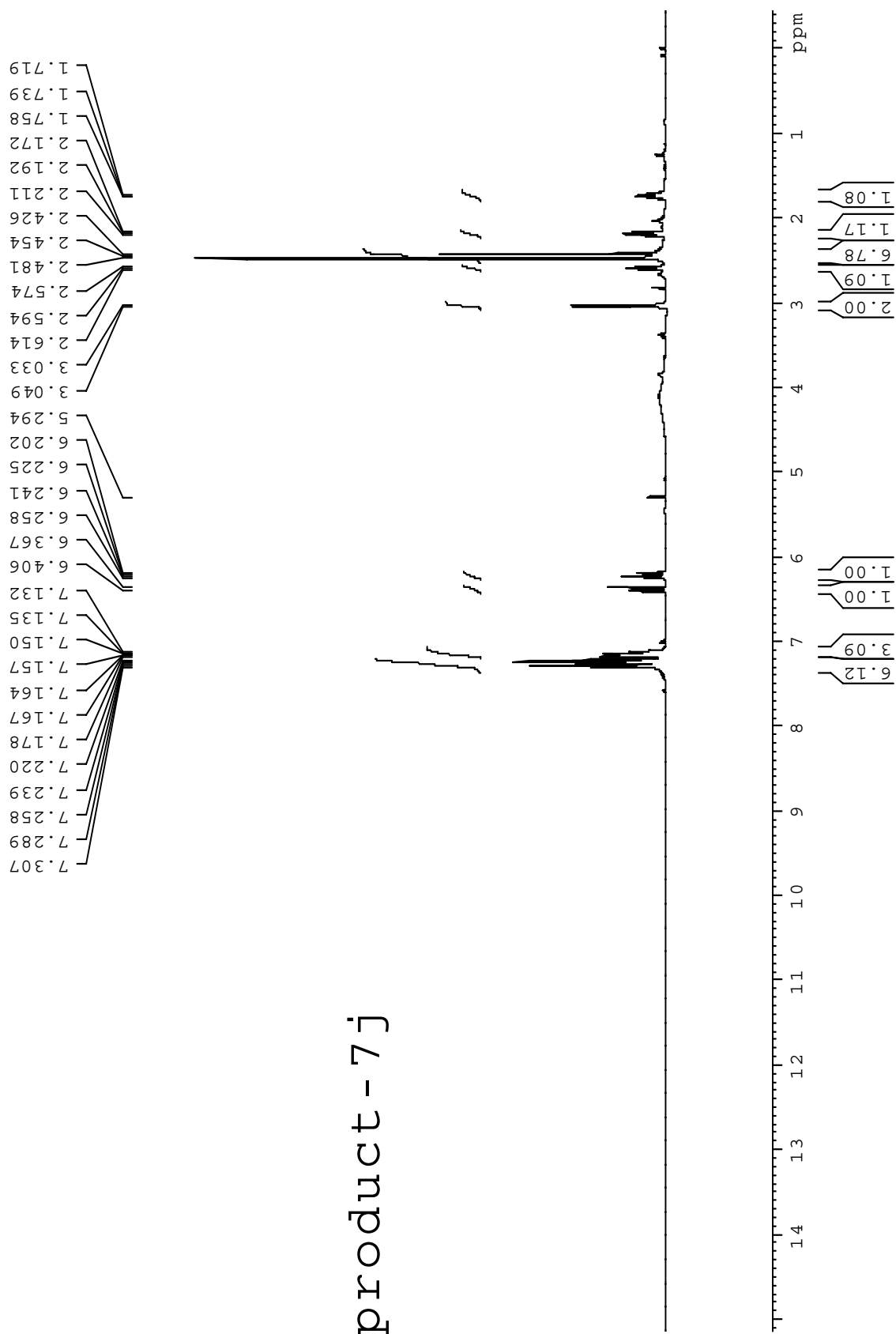

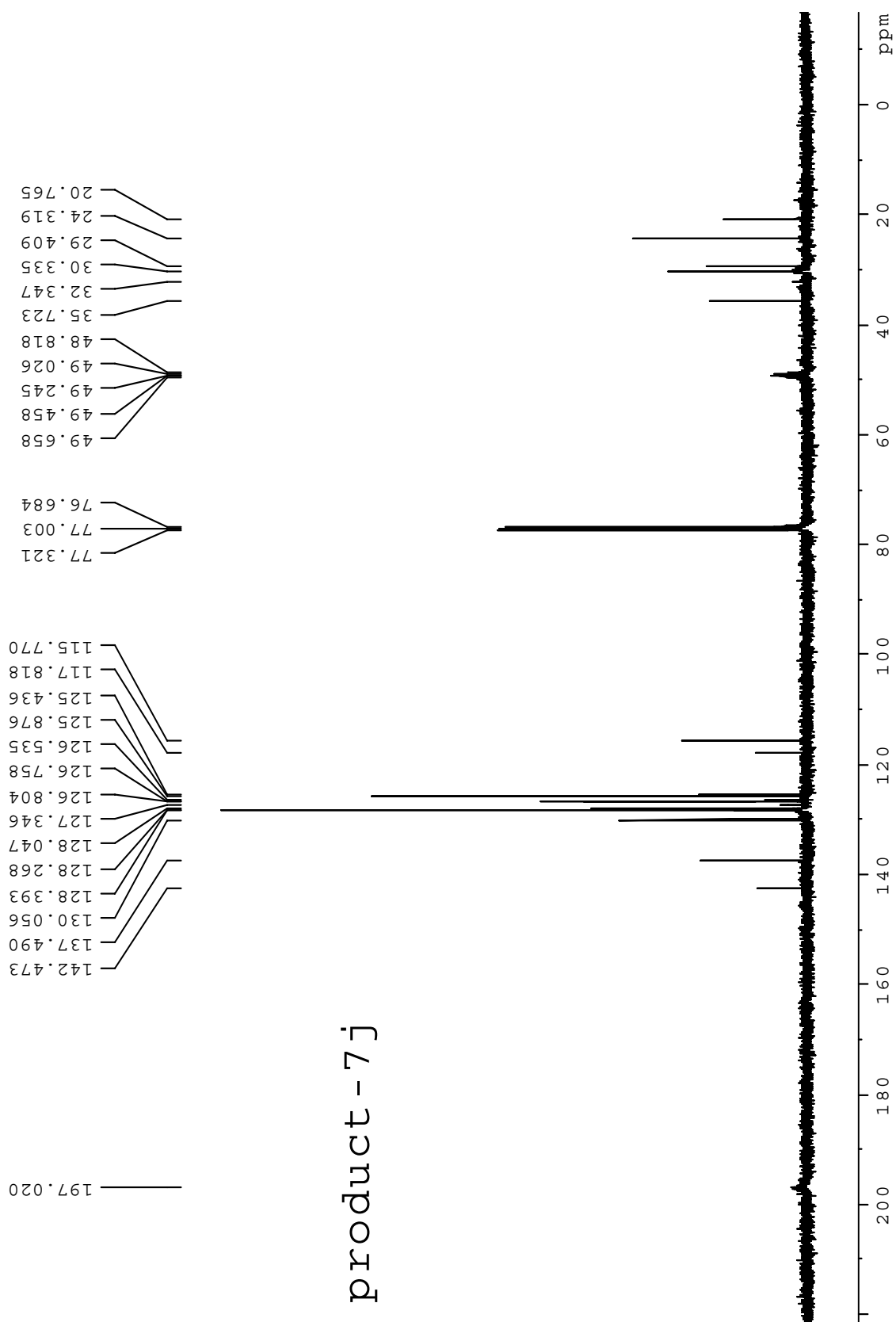

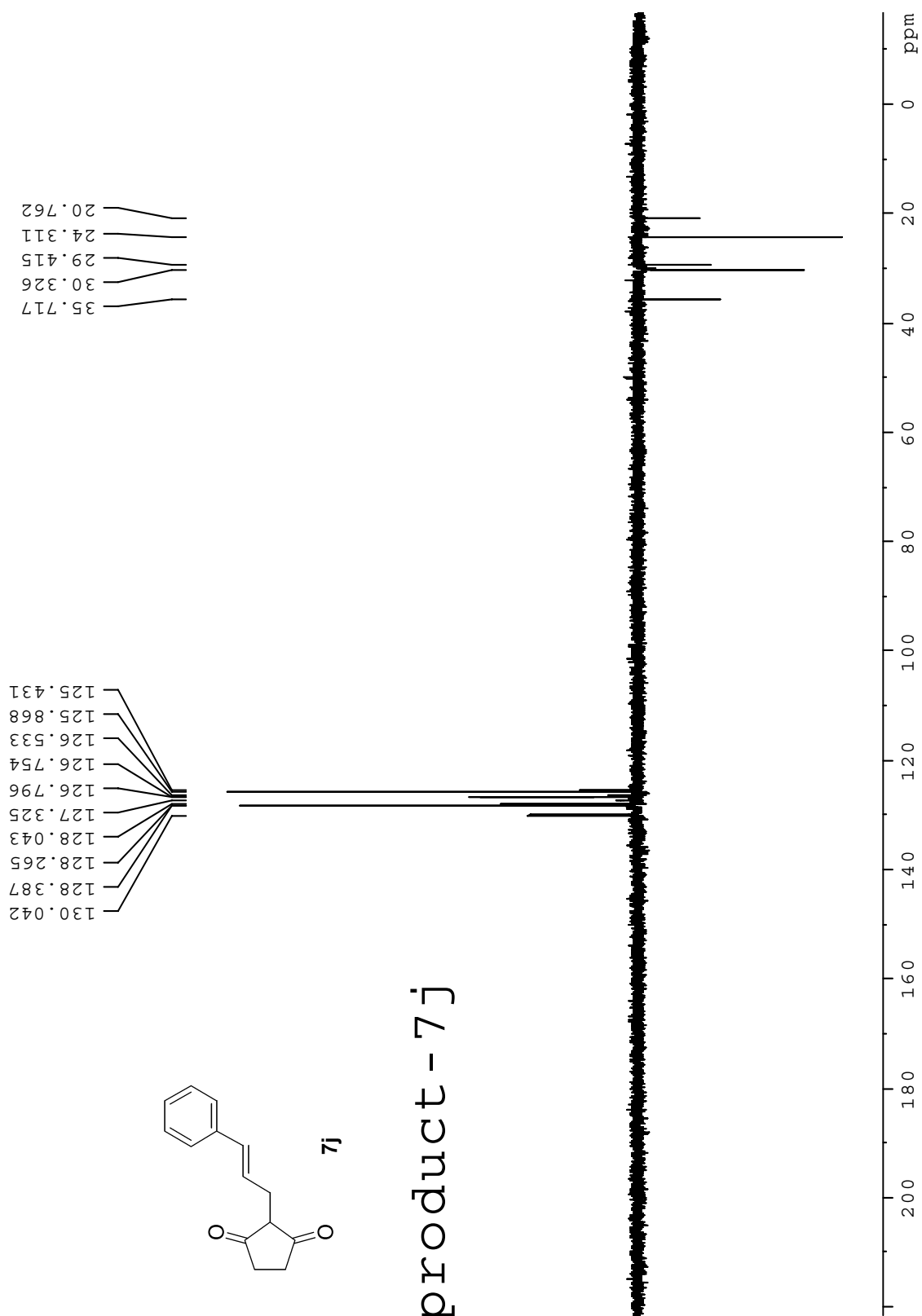

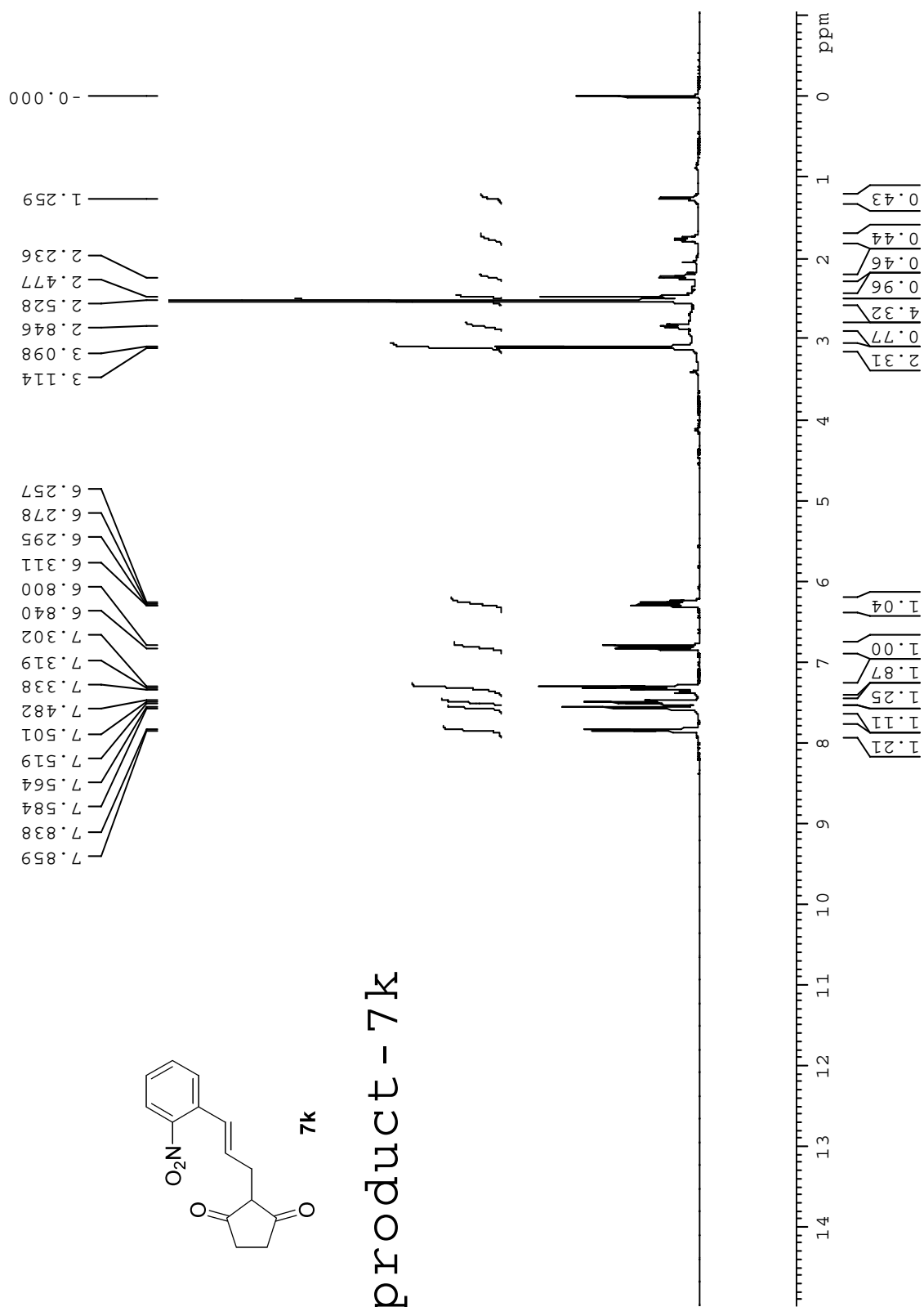



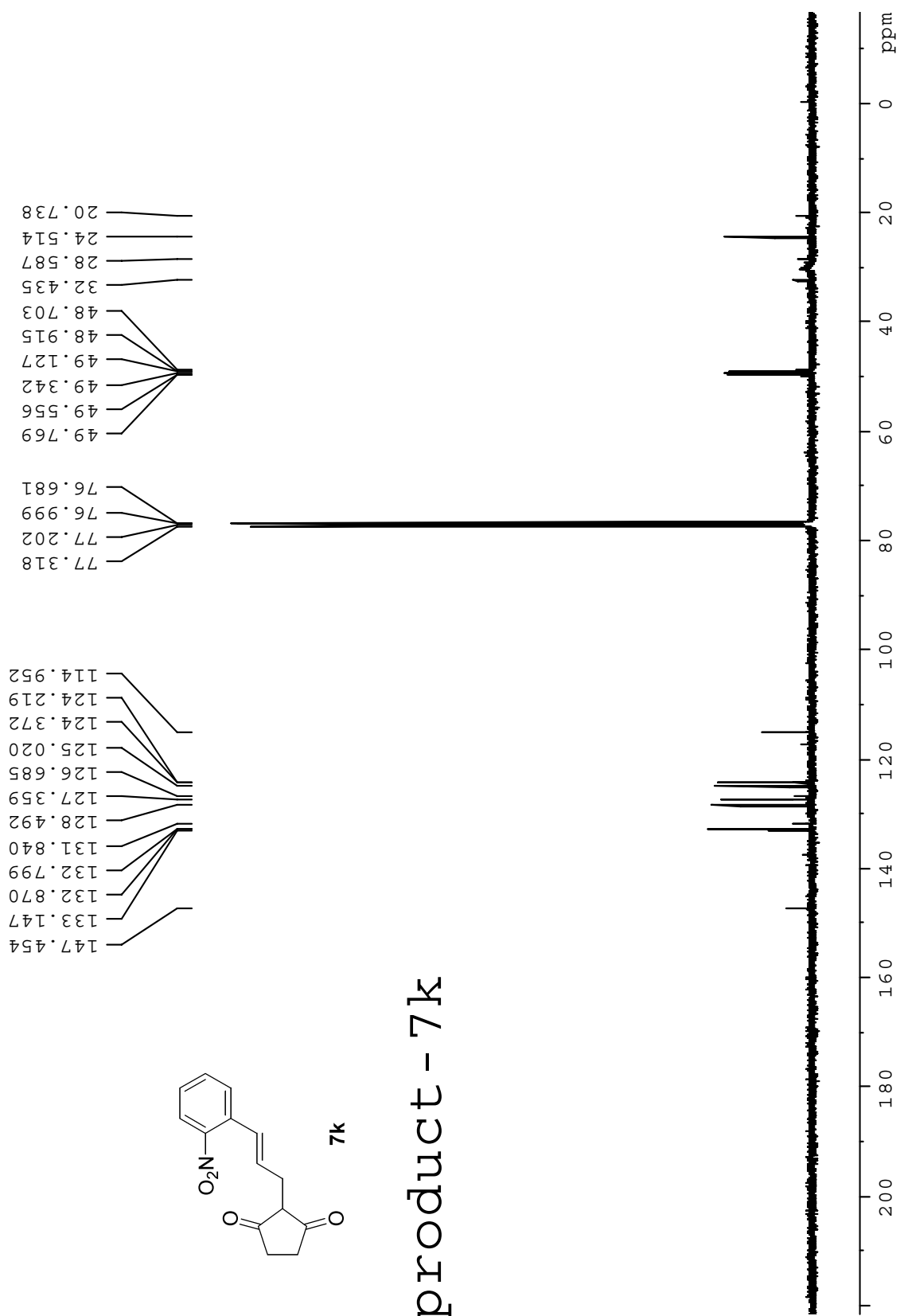

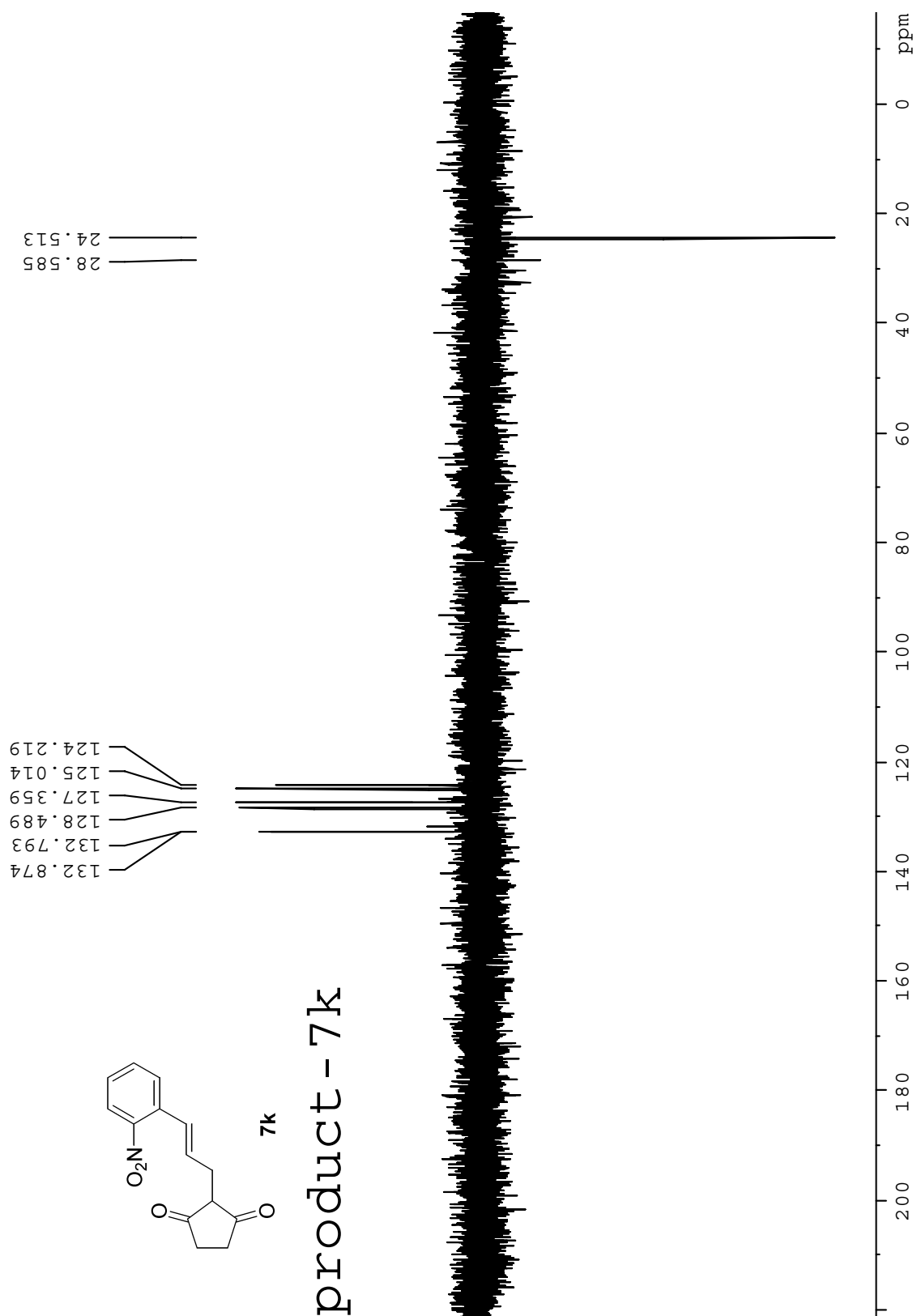

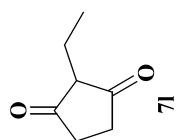

# product - 71

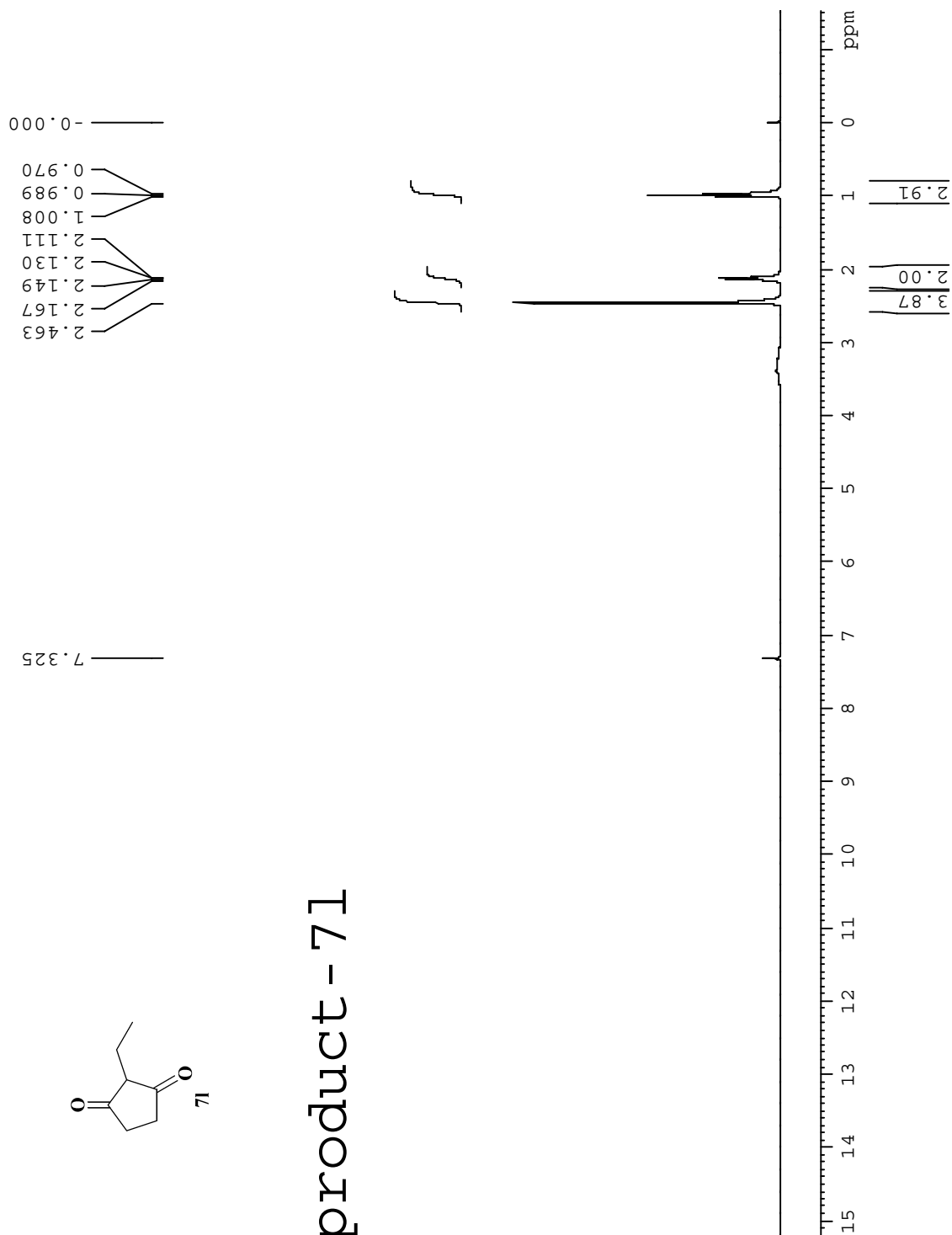

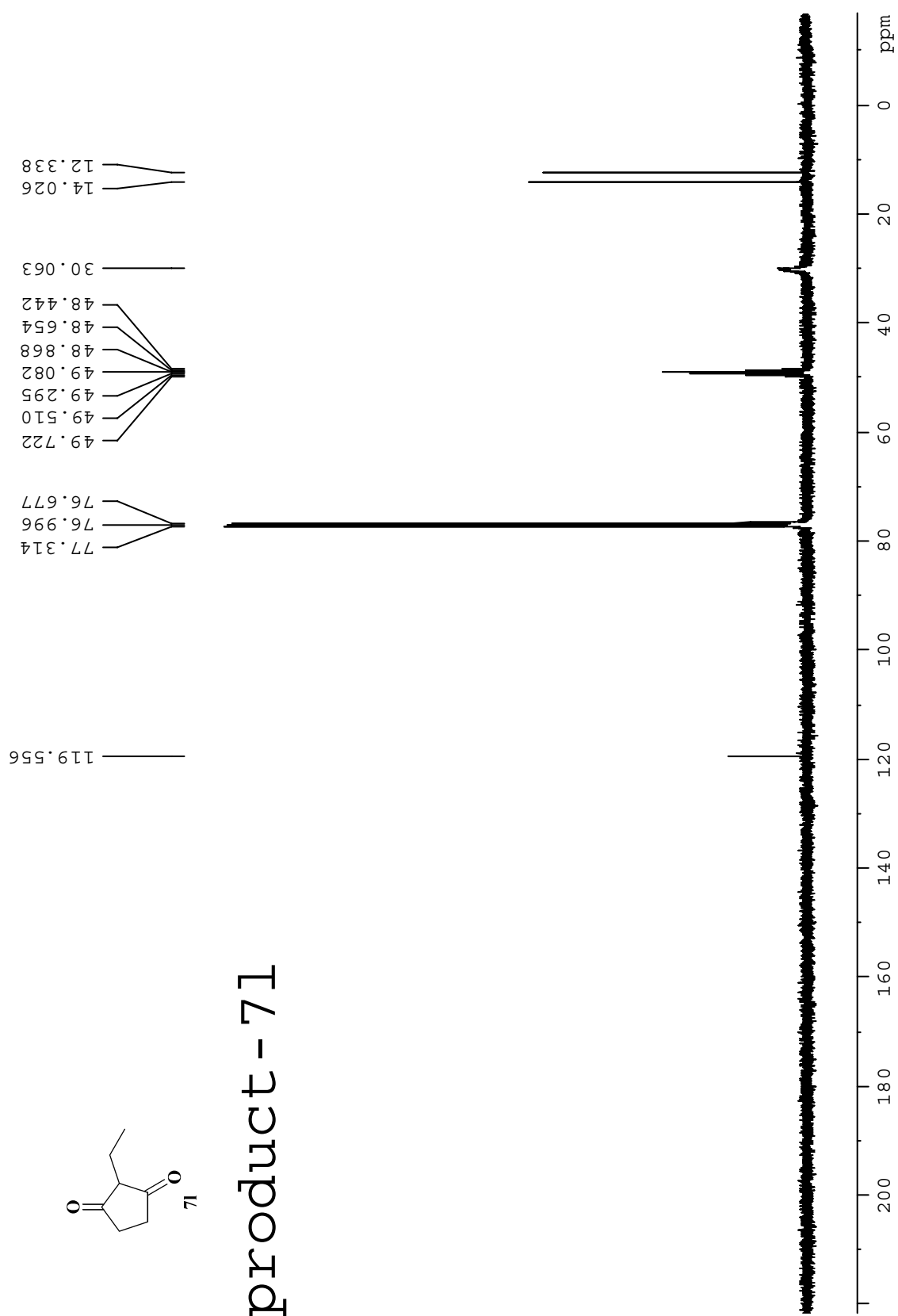

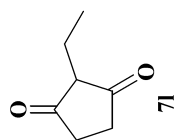

product - 71

14.024  
12.343

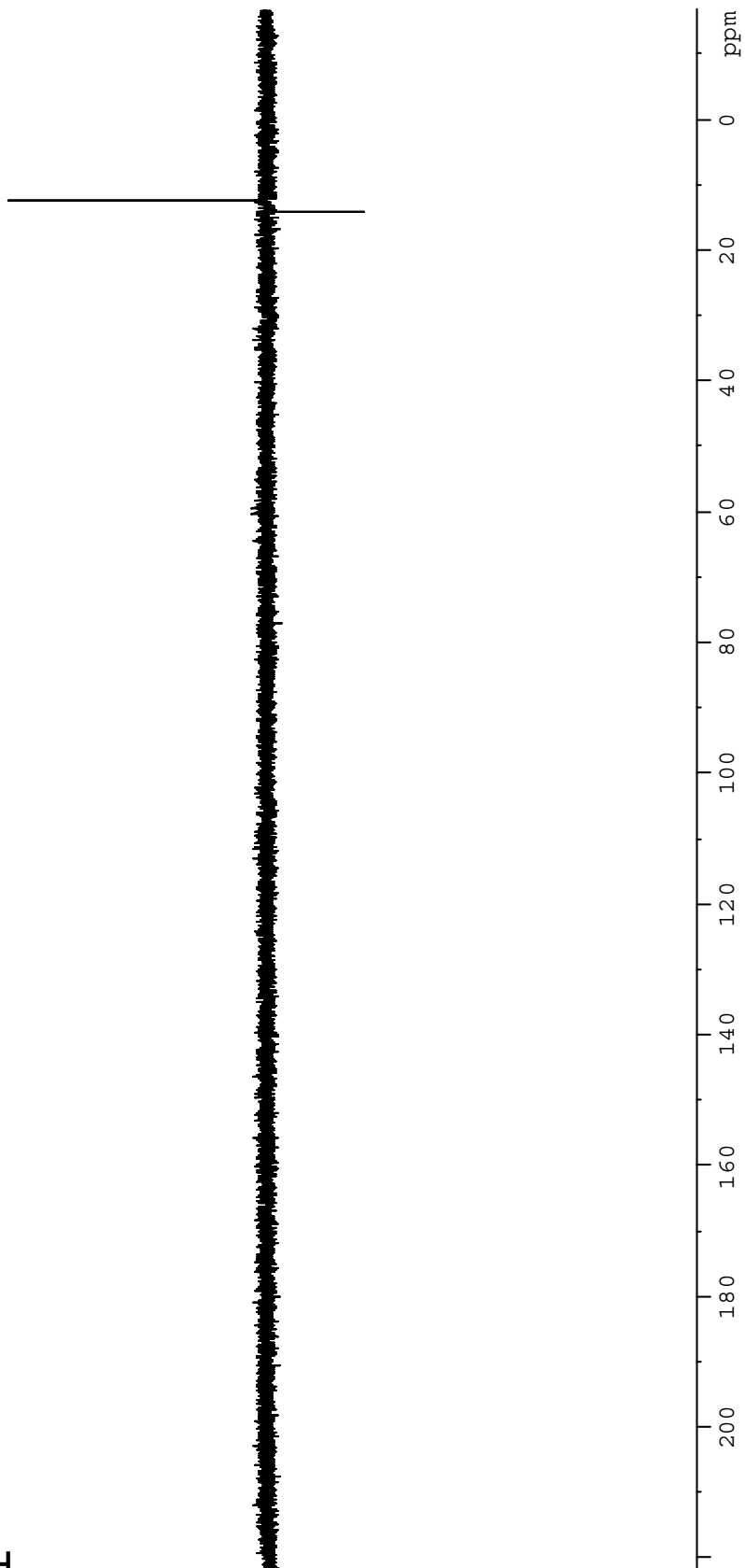

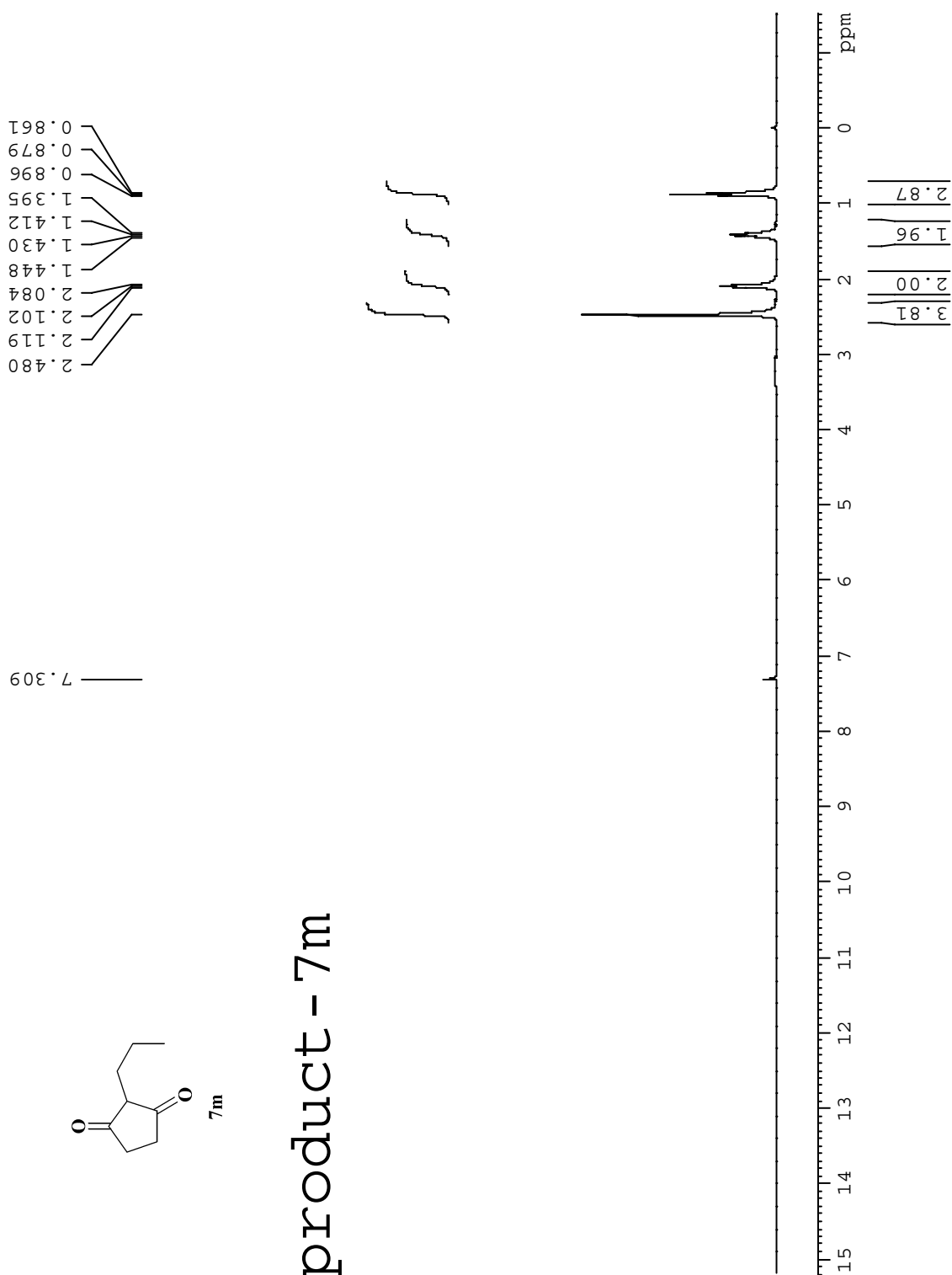

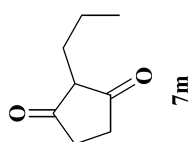

# product - 7m

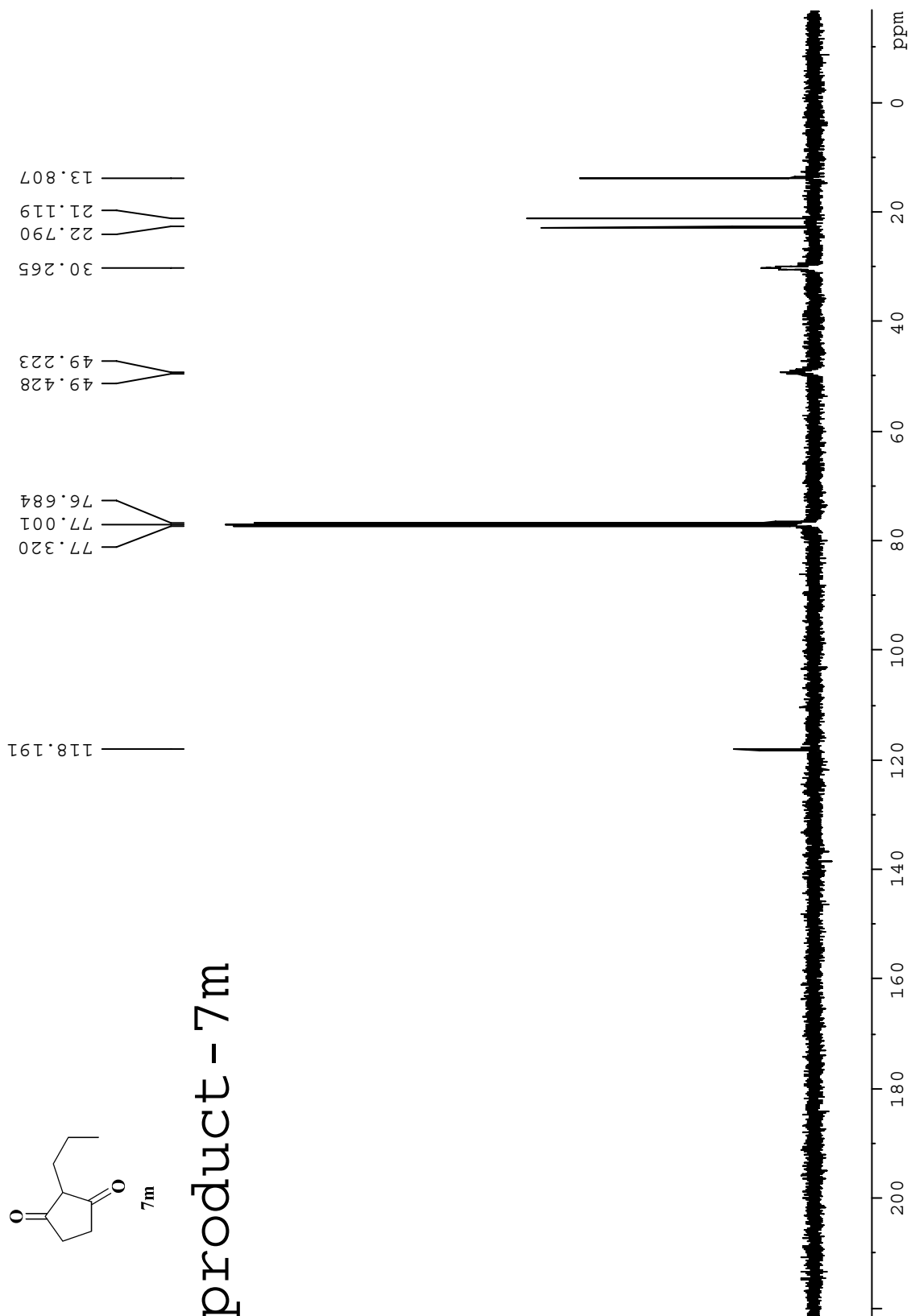

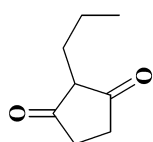

7m

product - 7m

13.812  
21.133  
22.786  
30.211

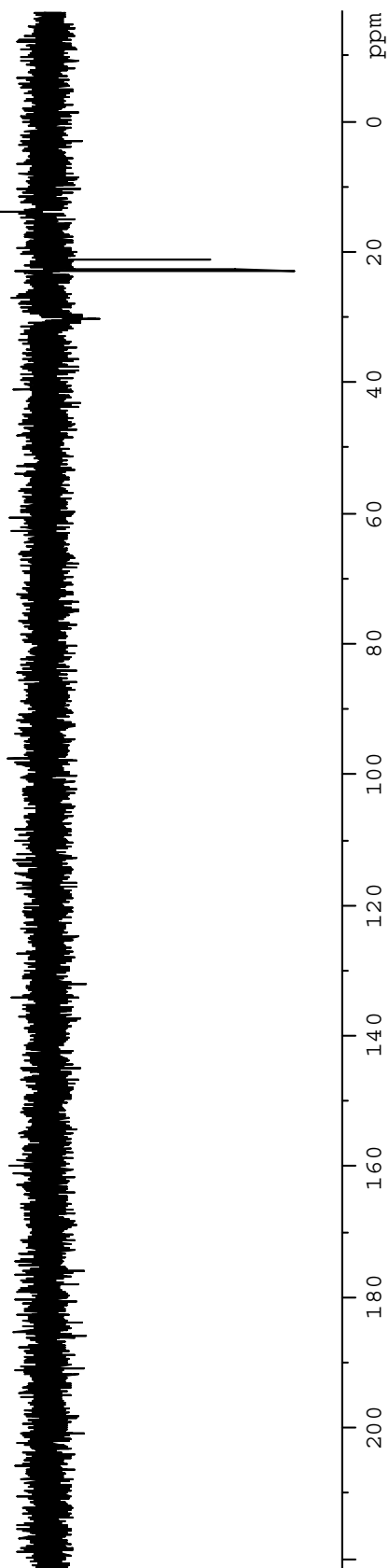



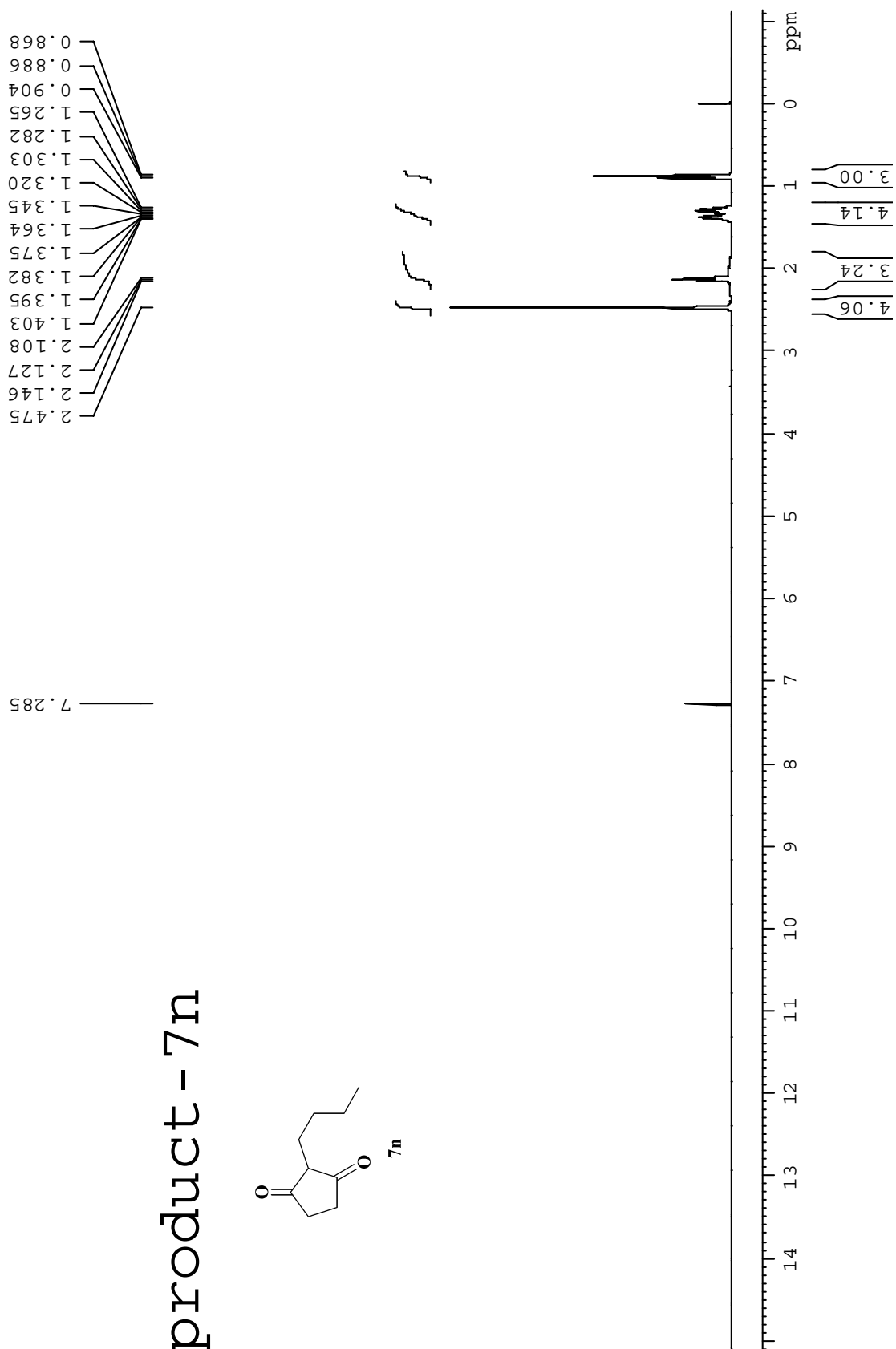

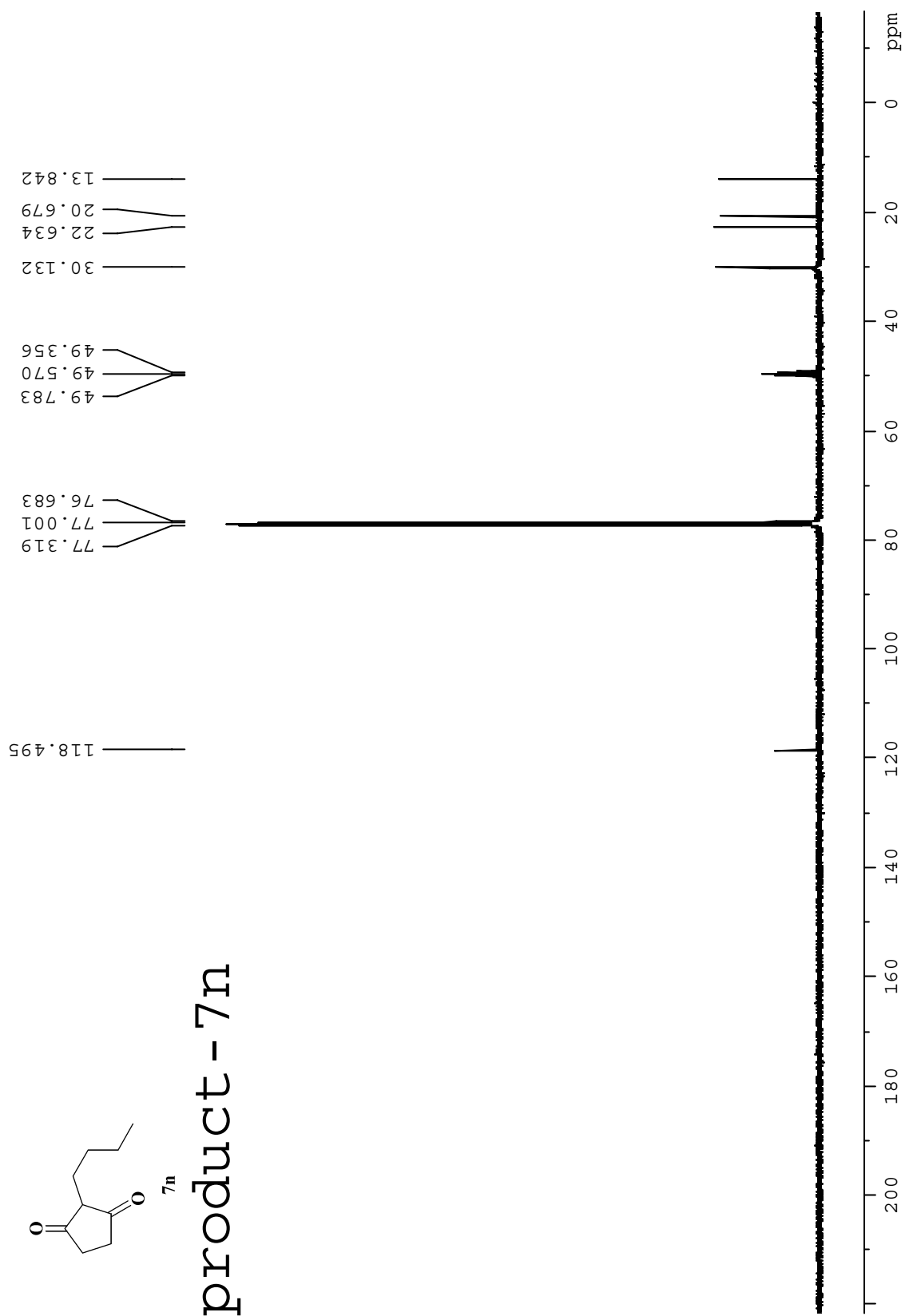

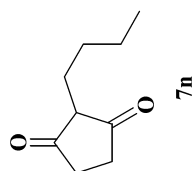

product - 7n

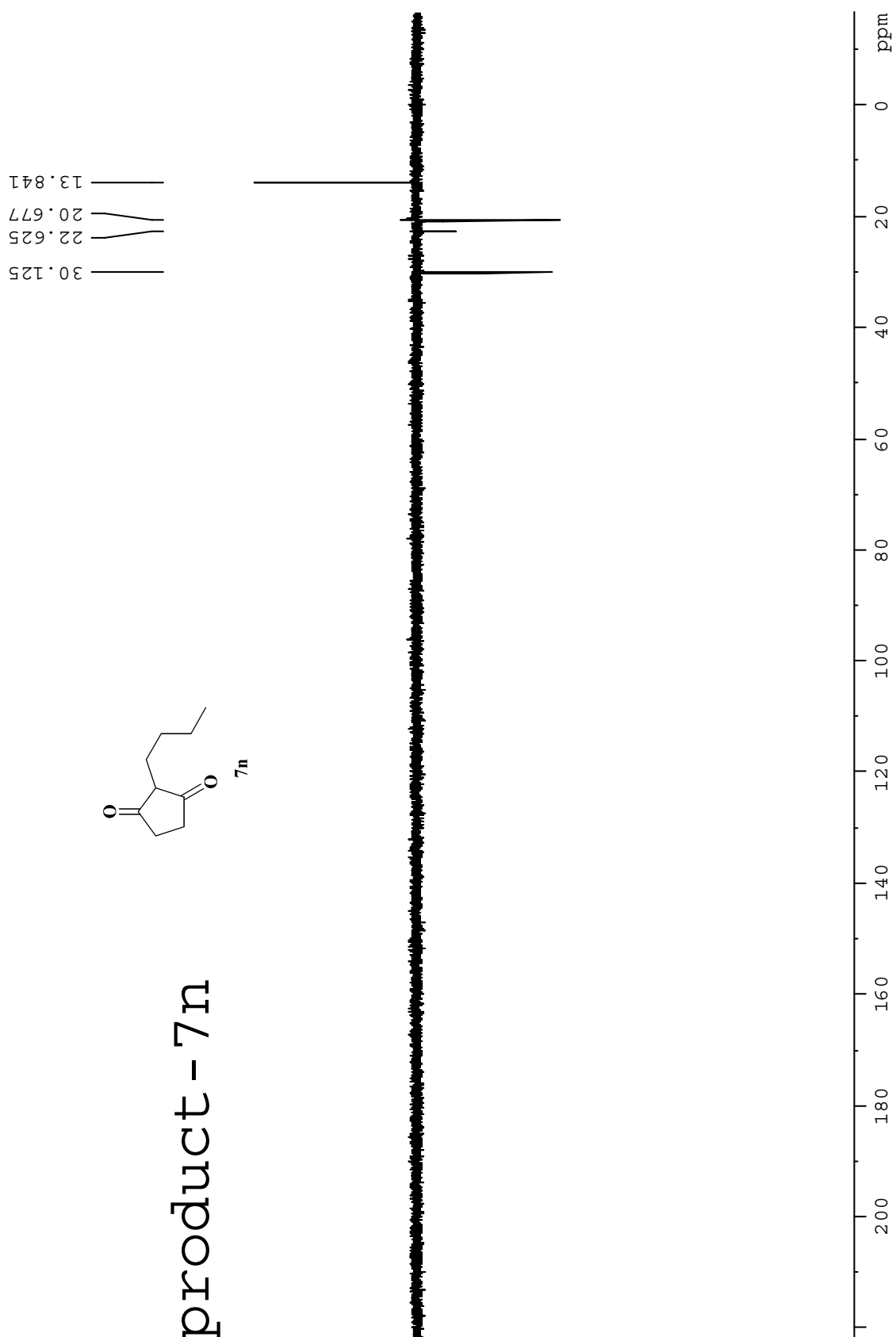

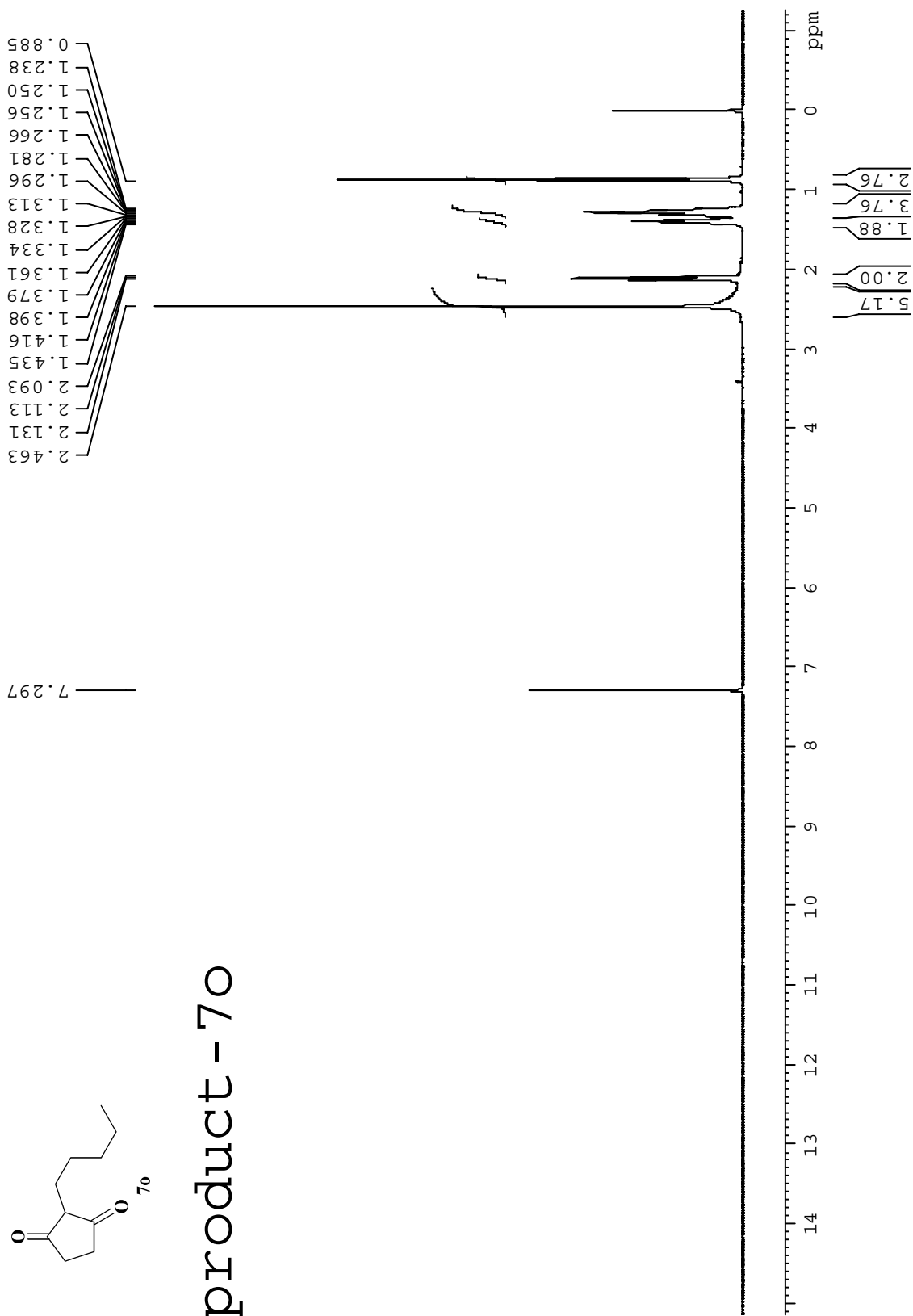

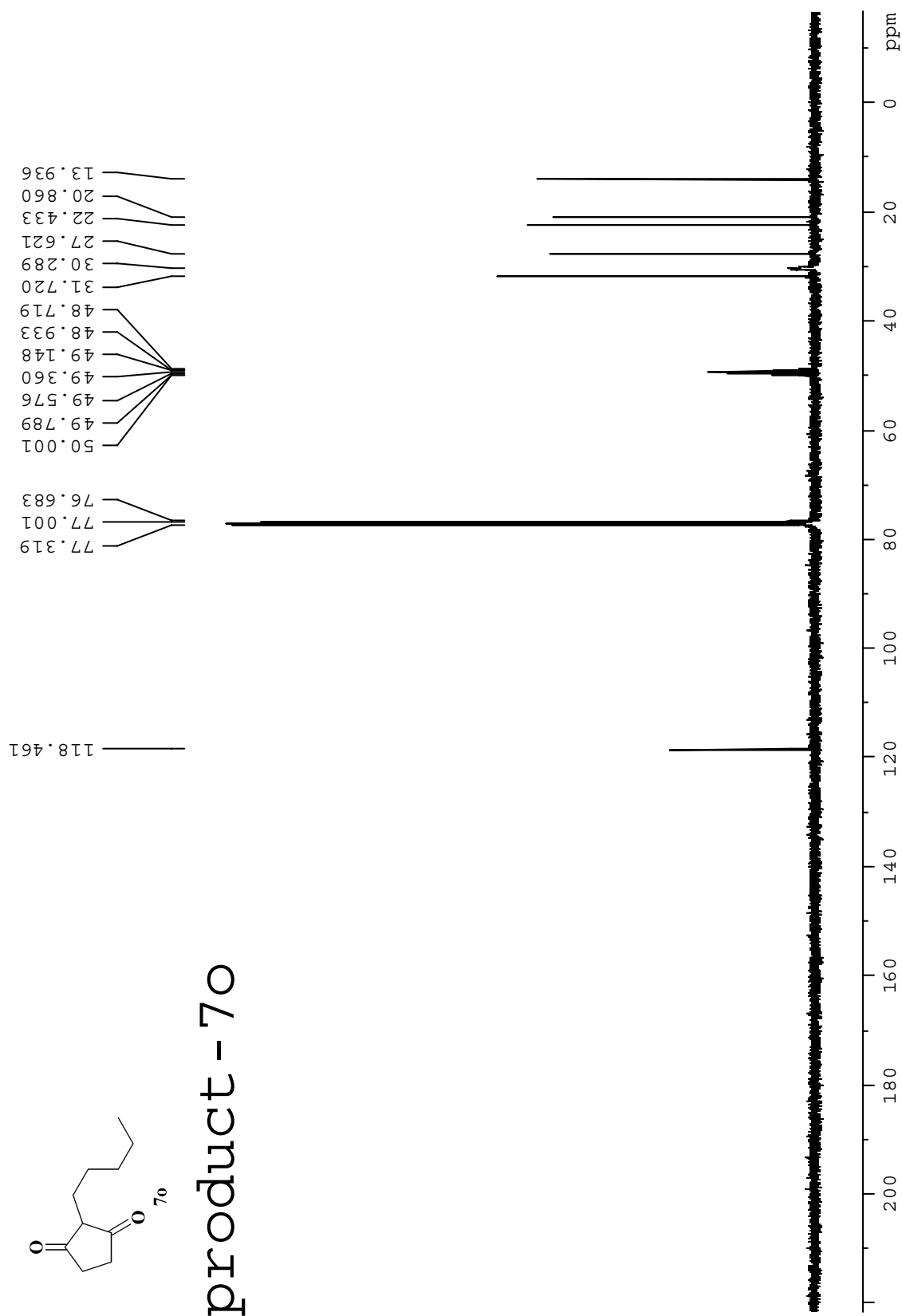

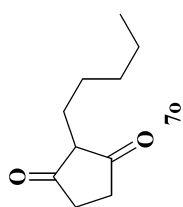

product - 70

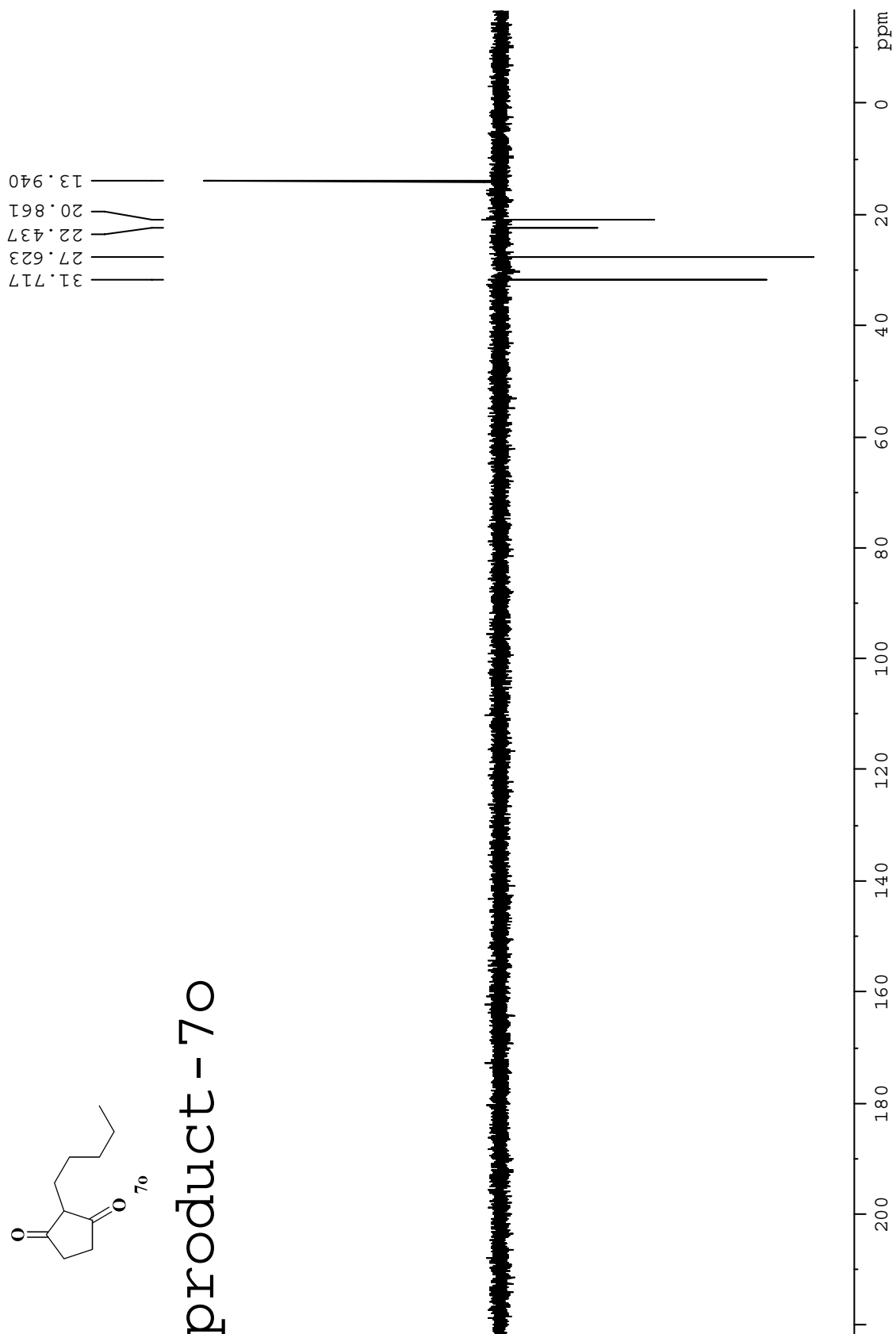

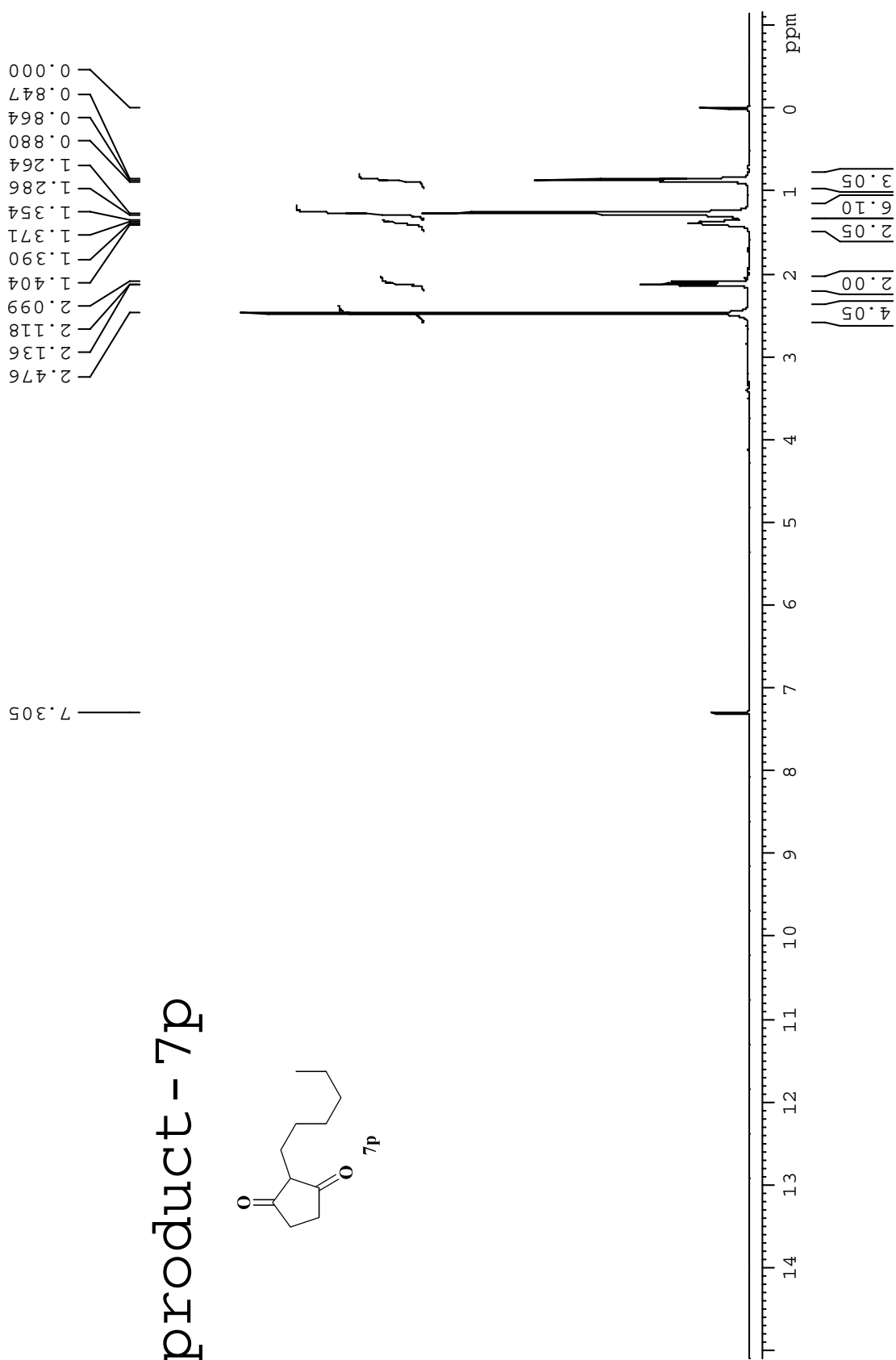

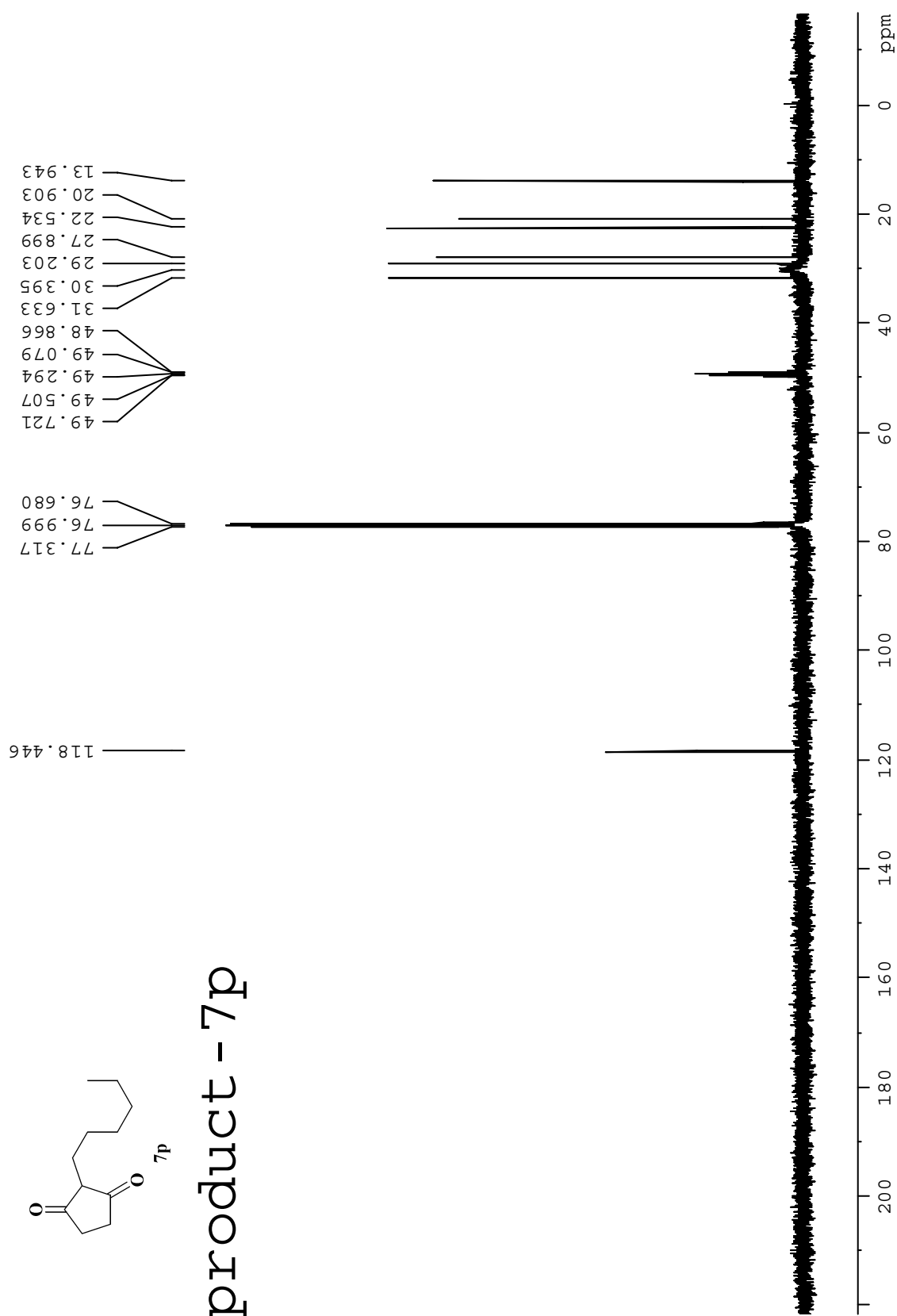



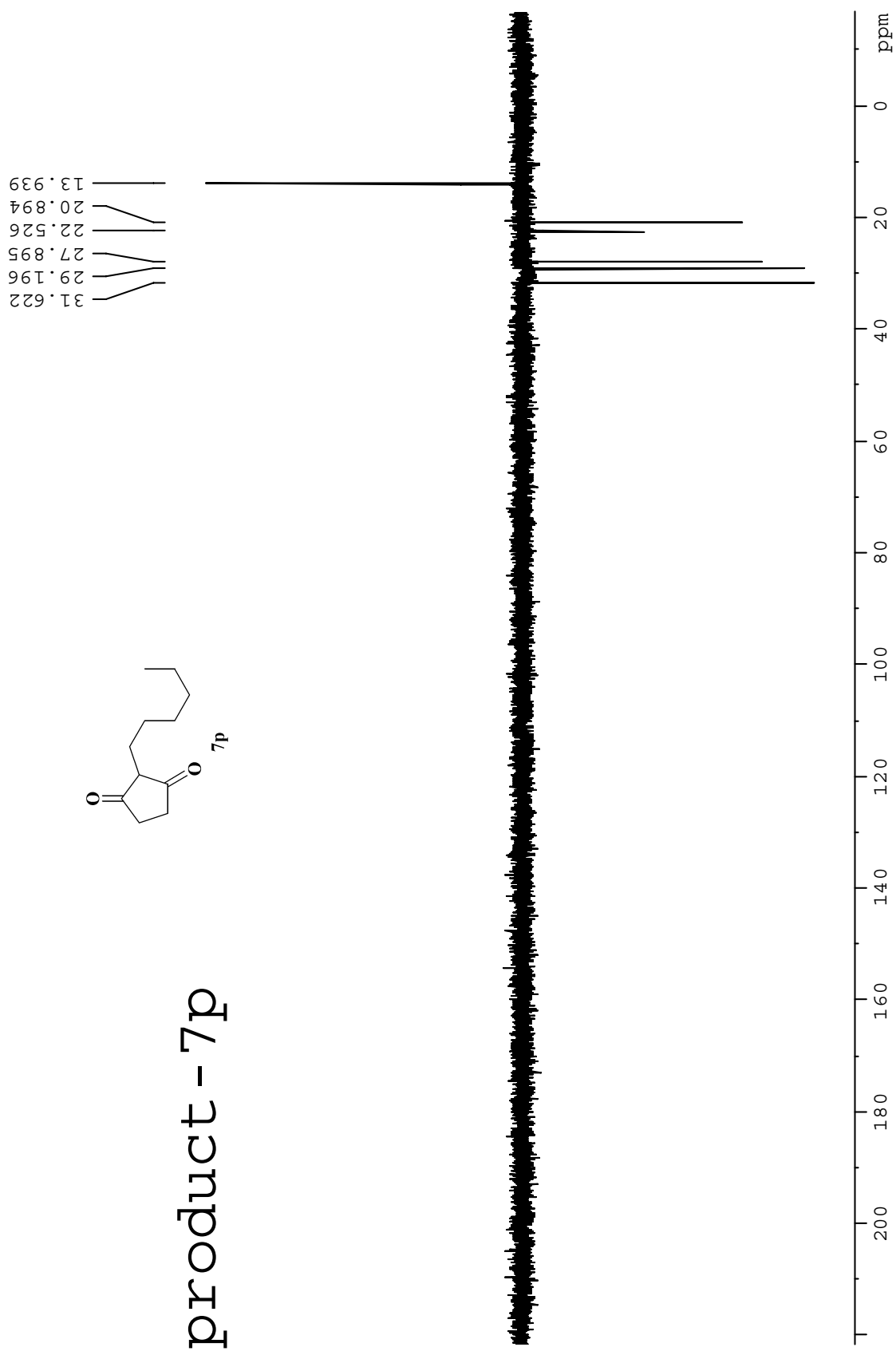

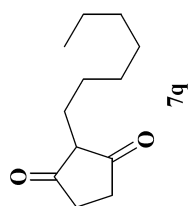

product - 7g

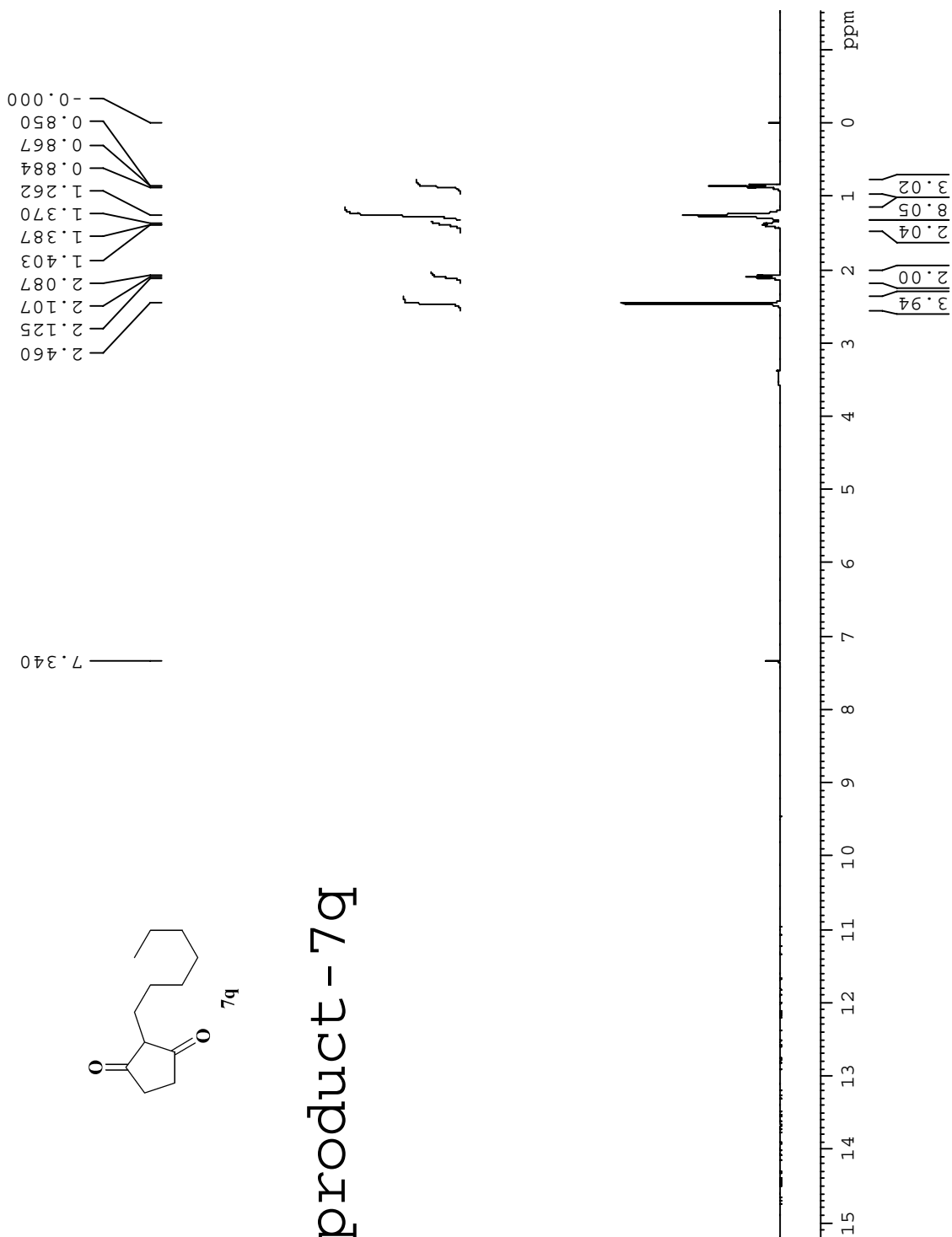

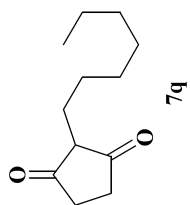
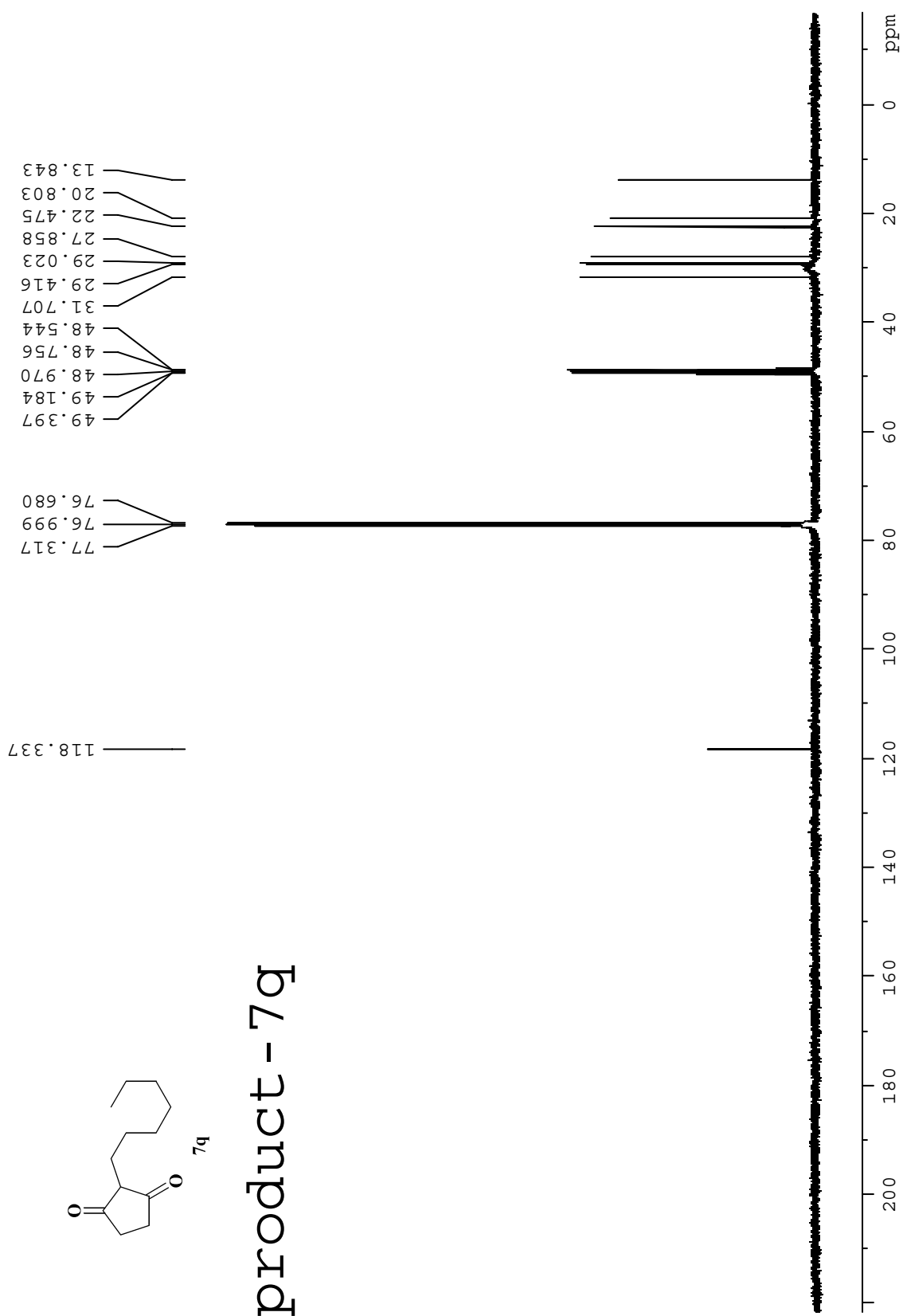

product - 7a

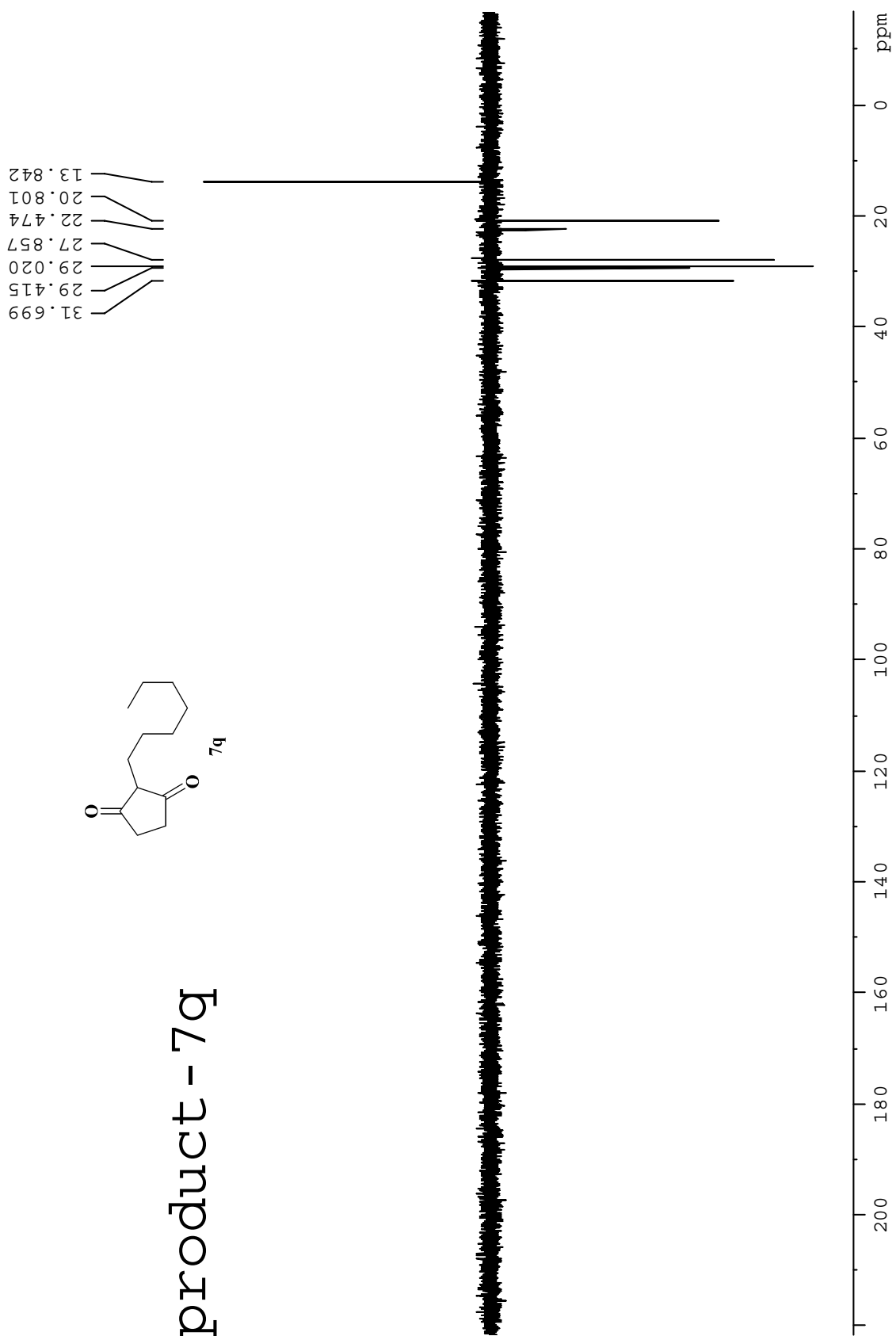

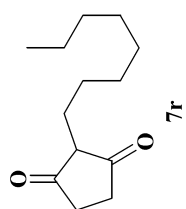

# product - 7r

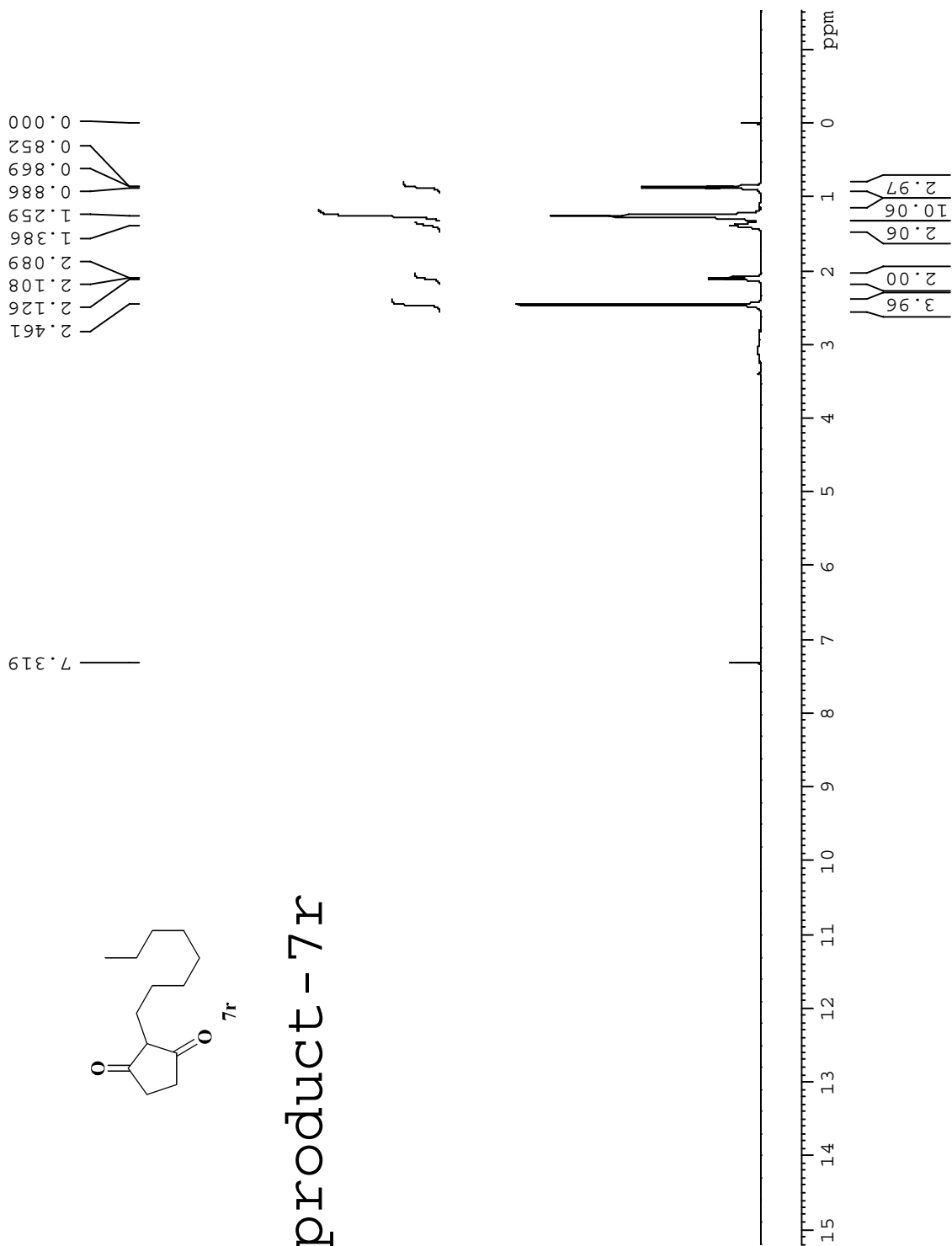

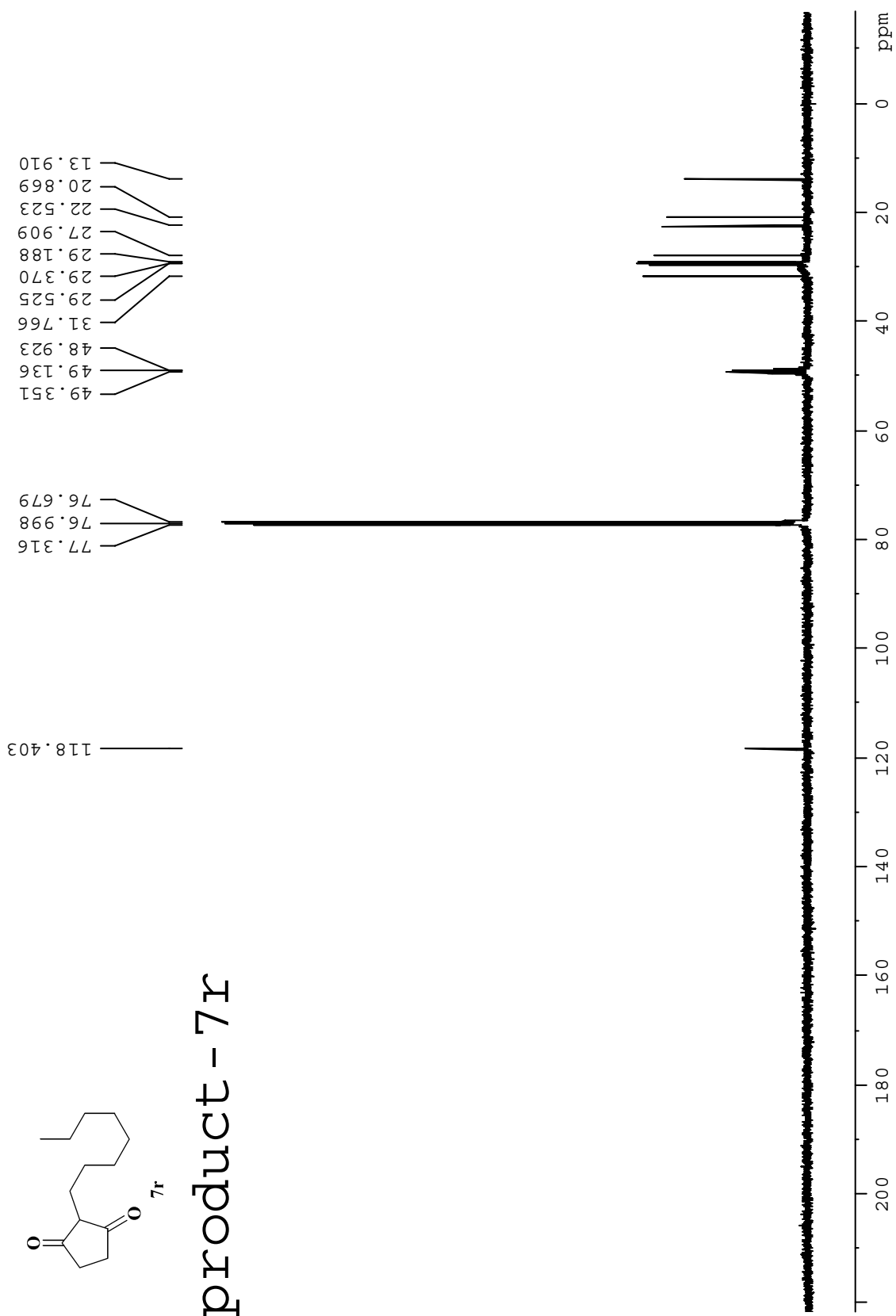

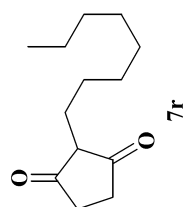

product - 7r

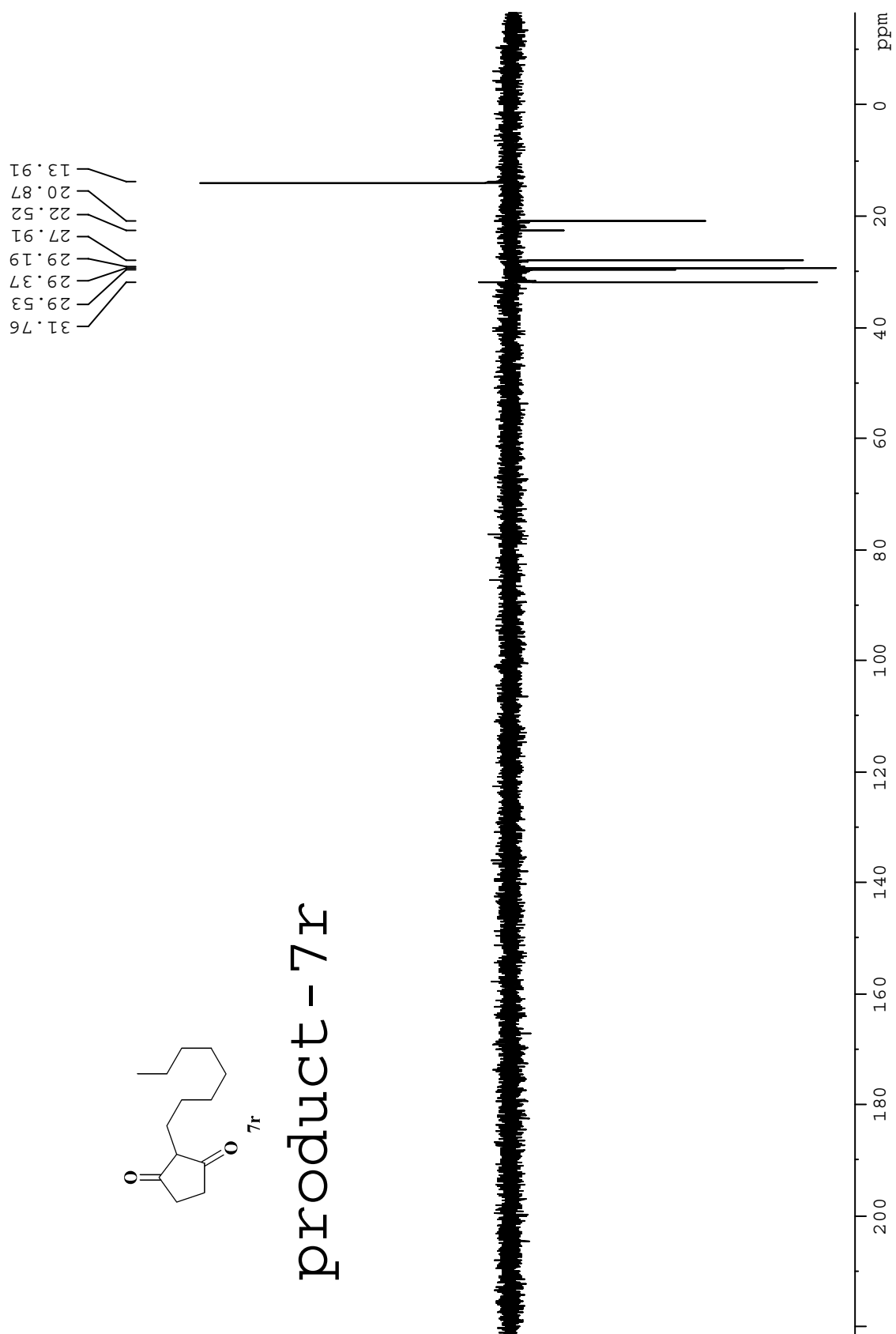

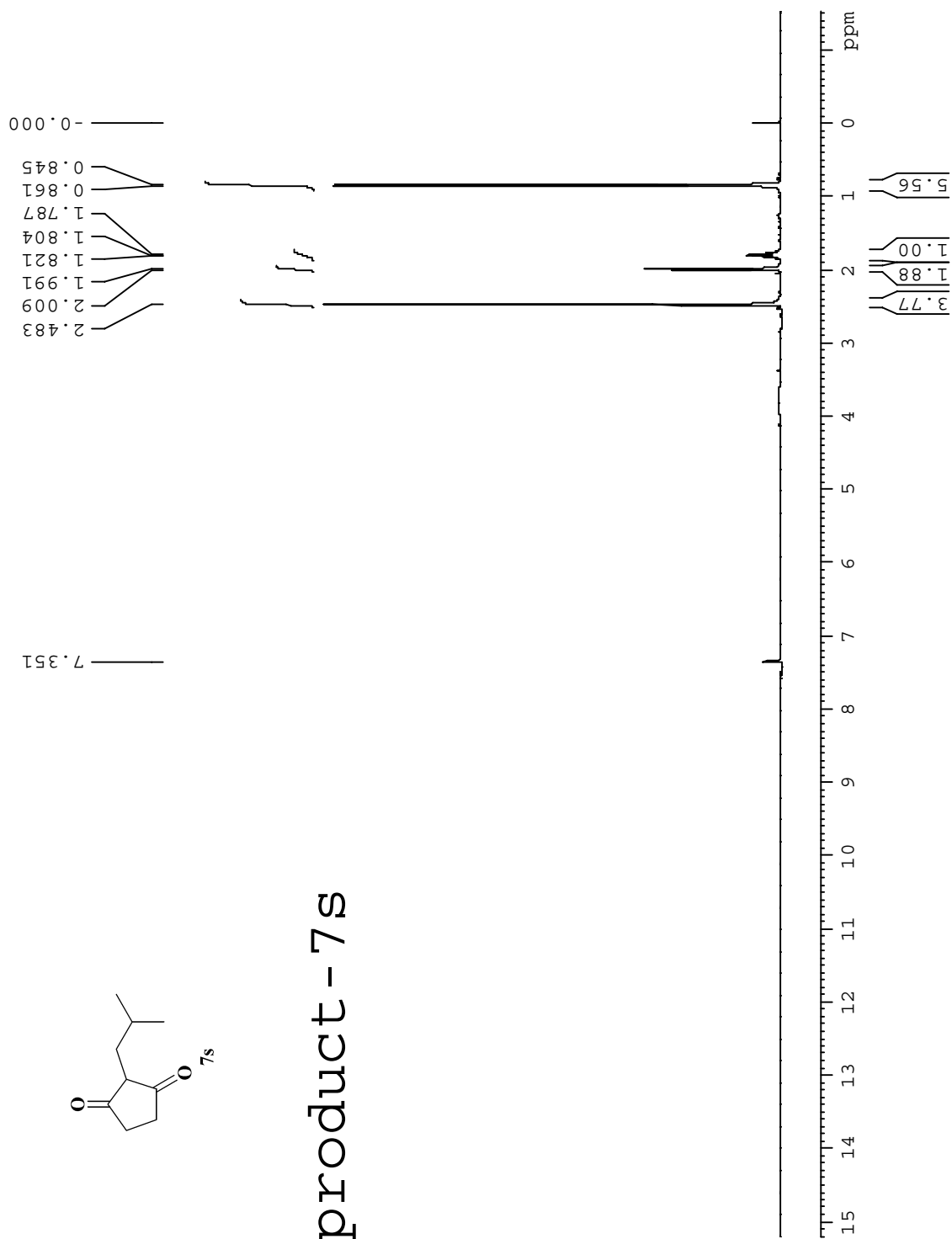



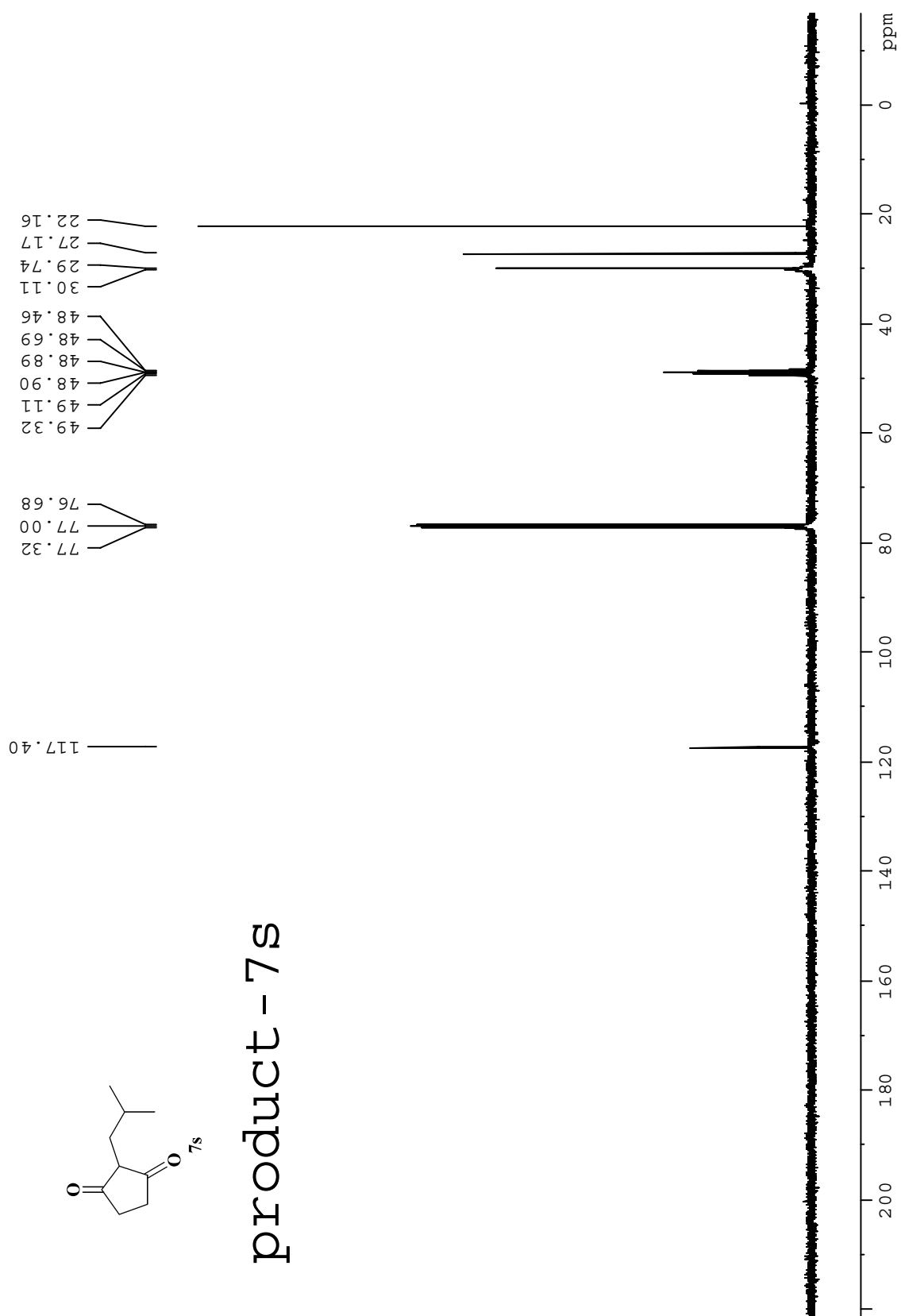

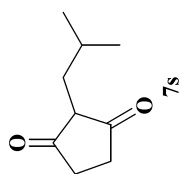

# product - 7s

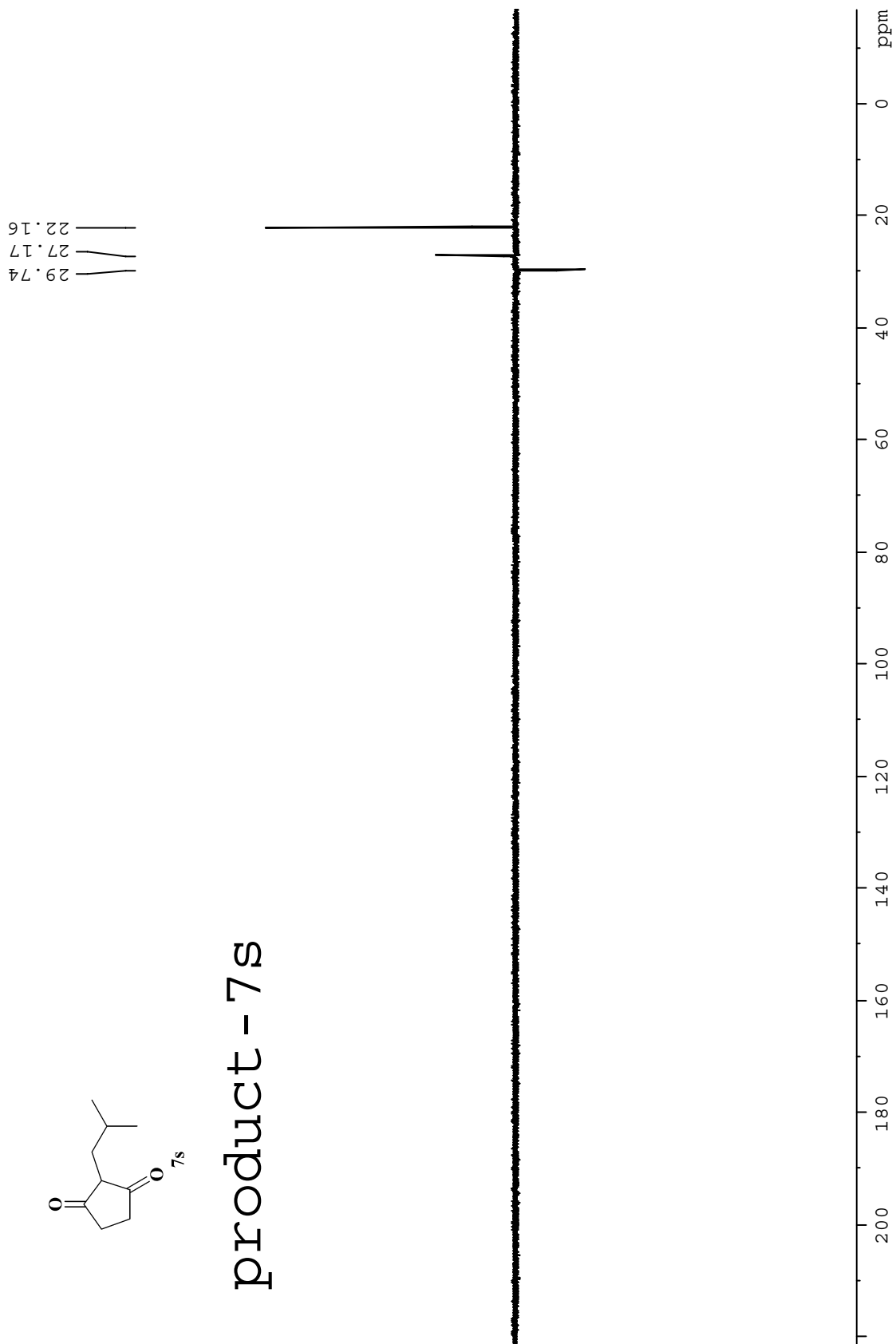

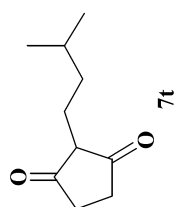

7t

# product - 7t

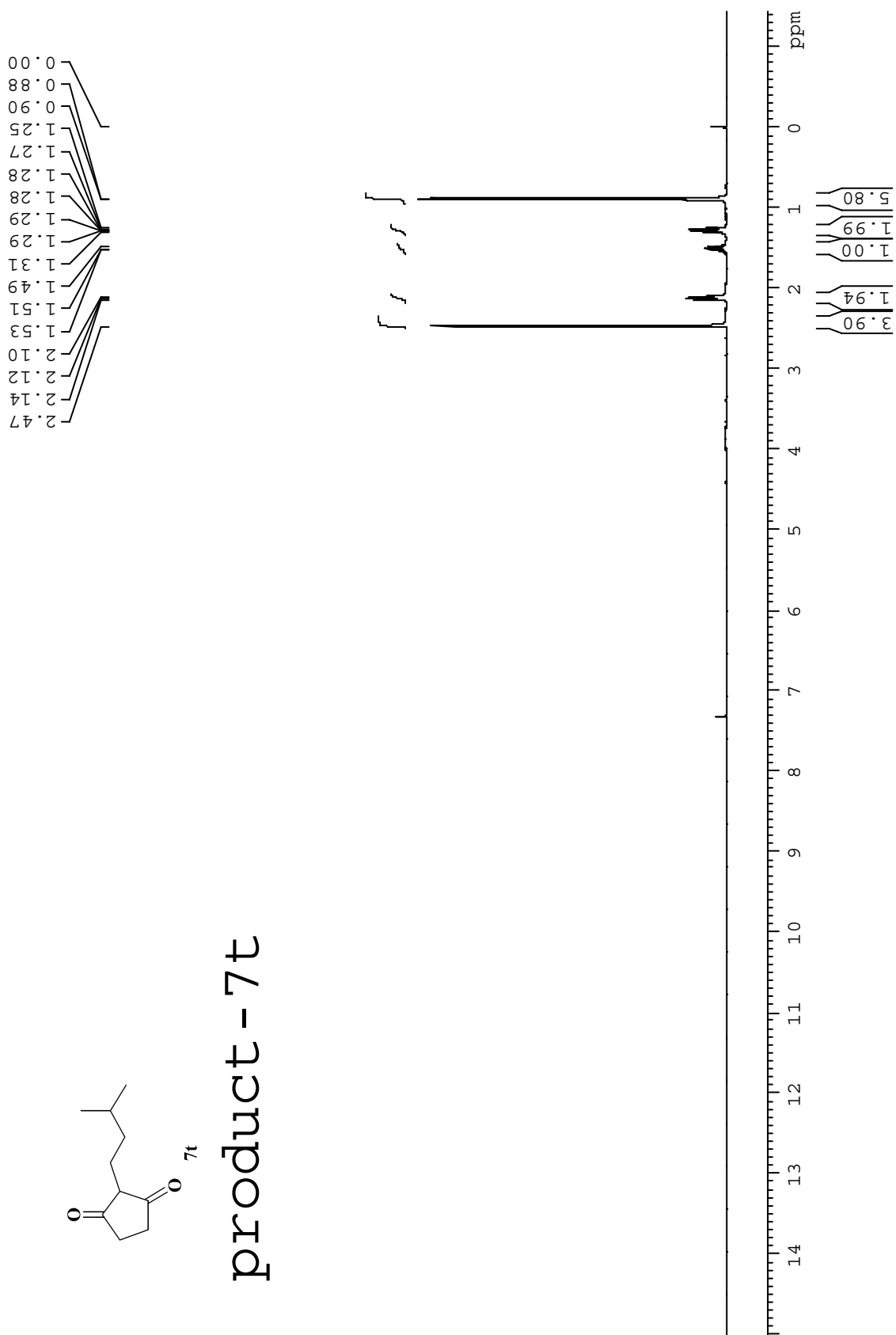

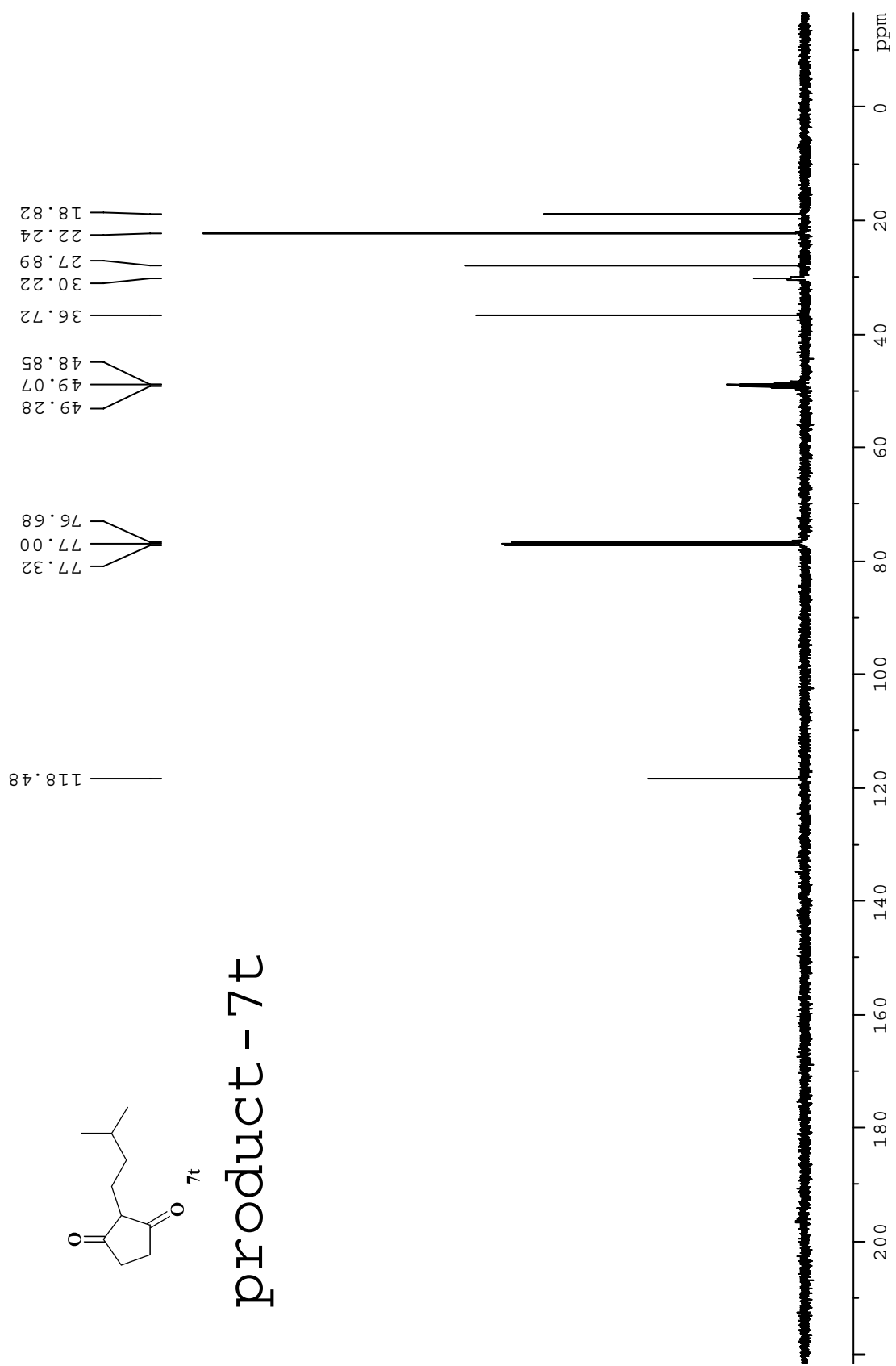

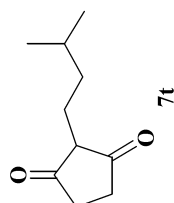

# product - 7t

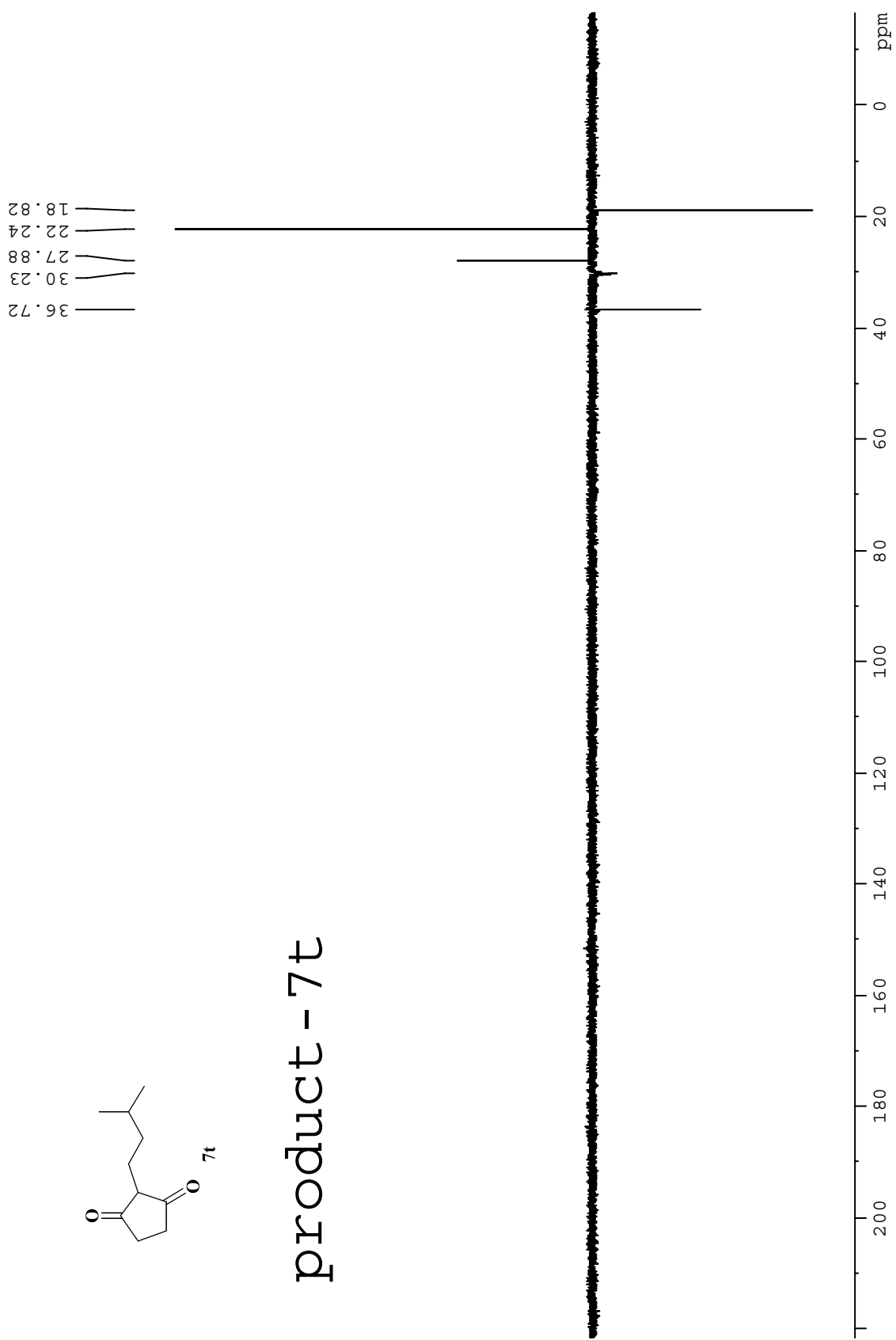

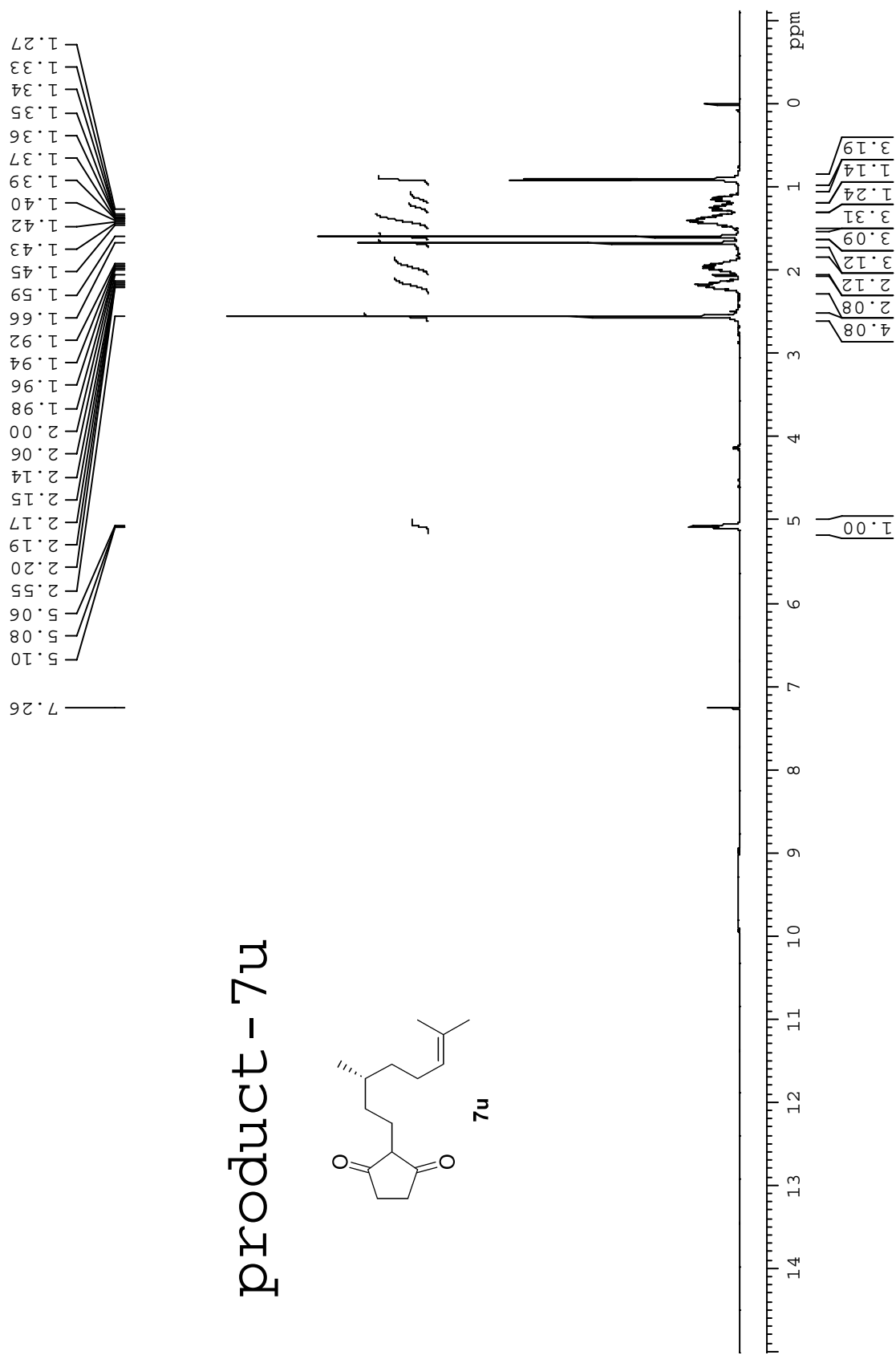

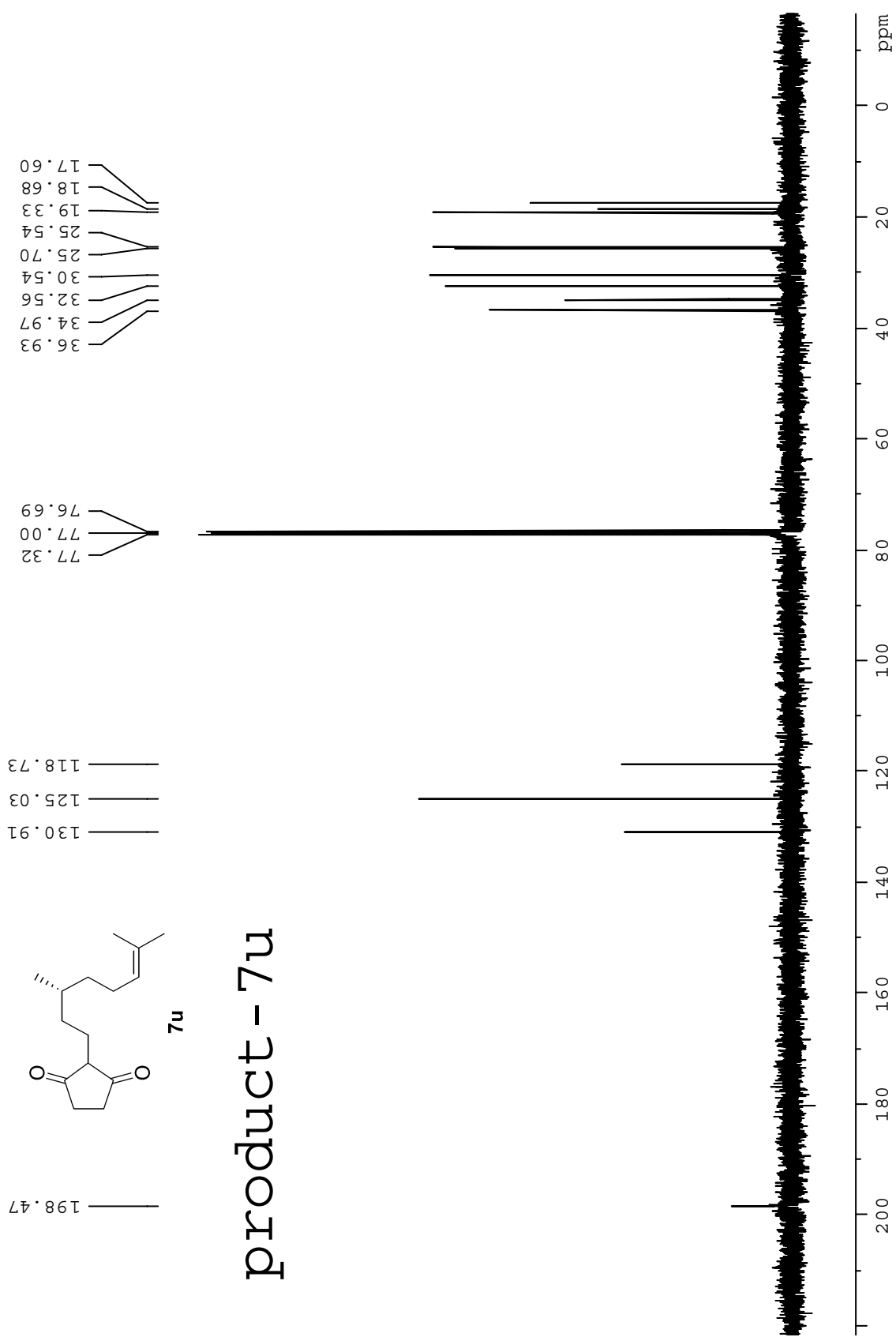

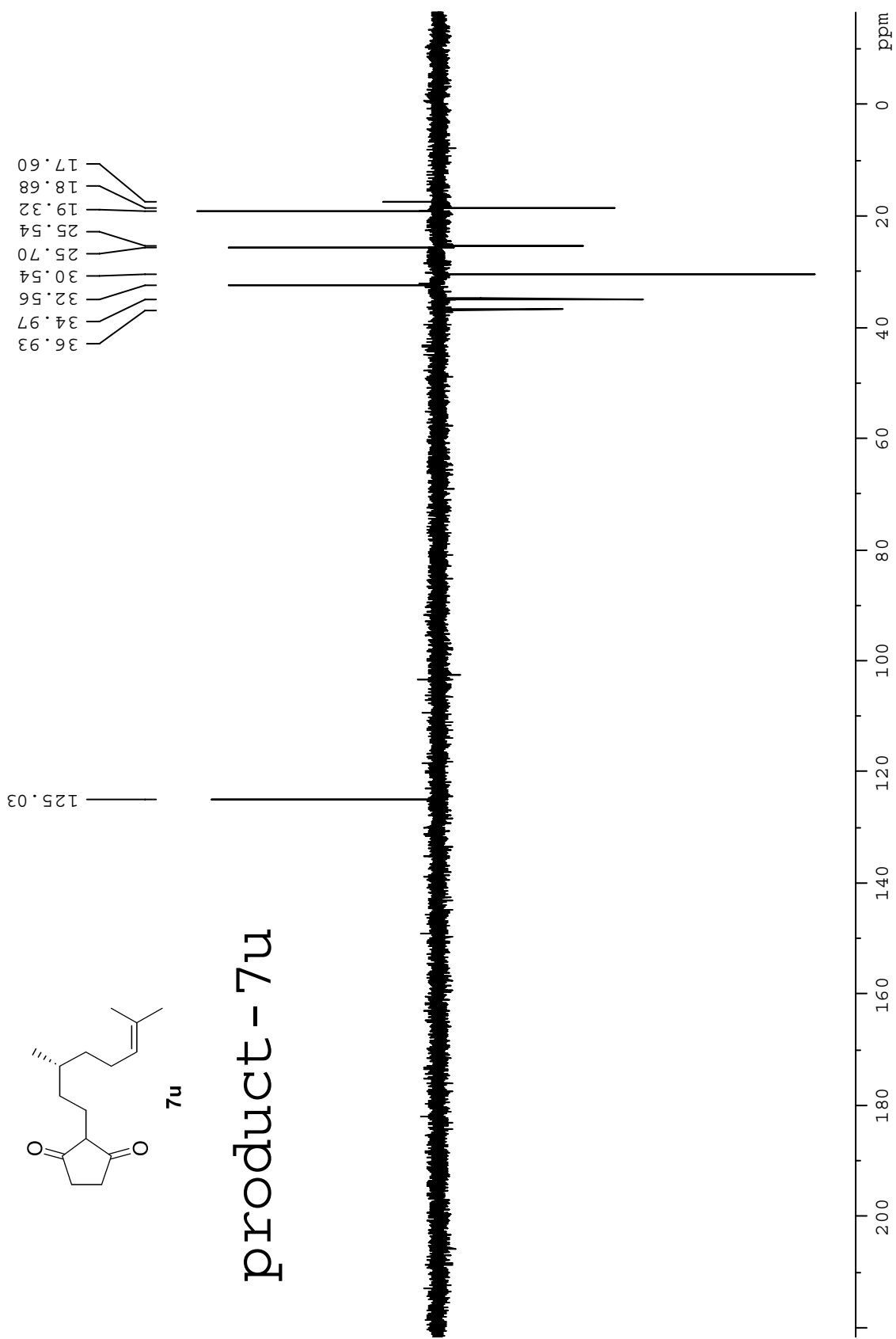



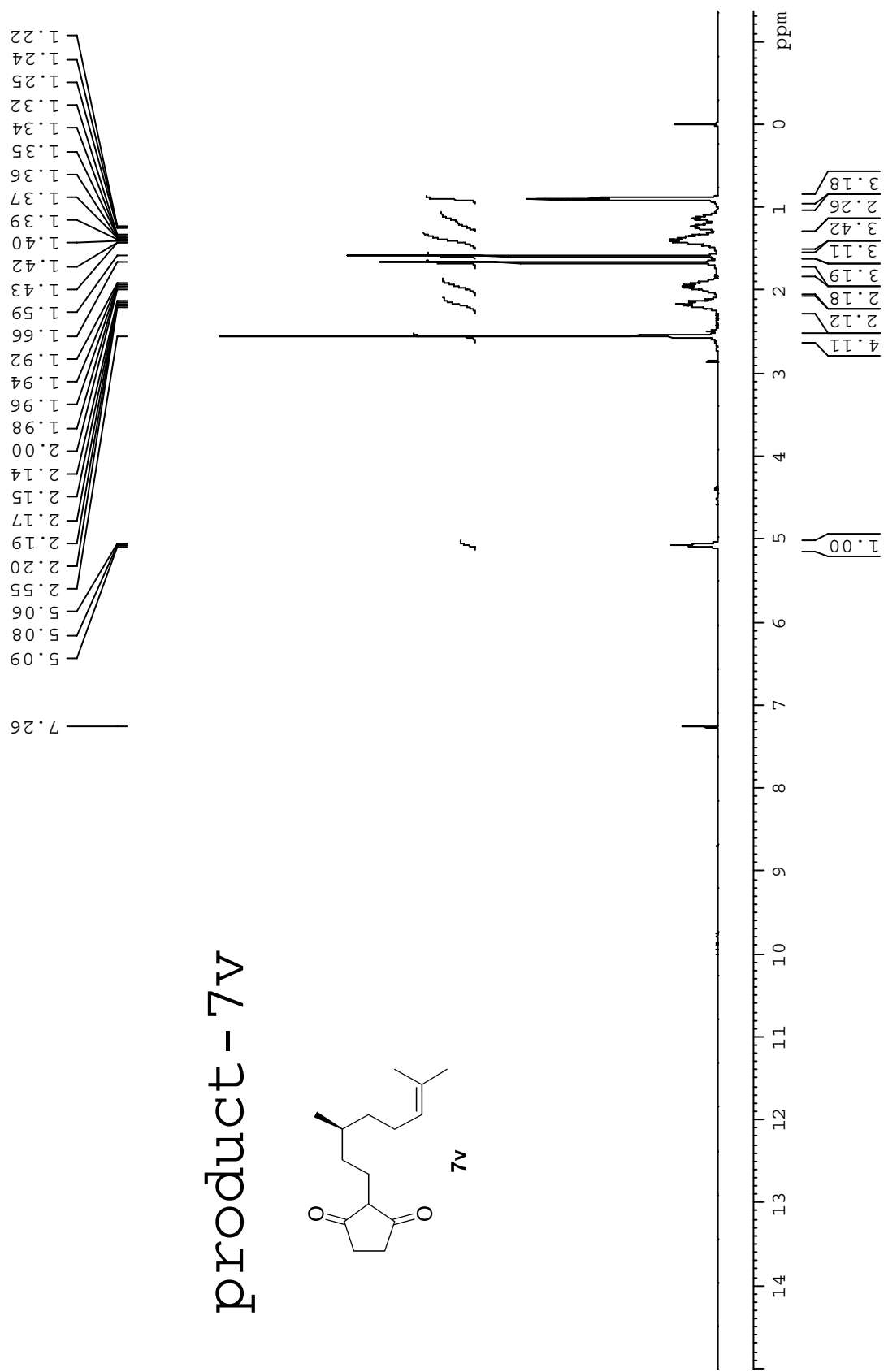

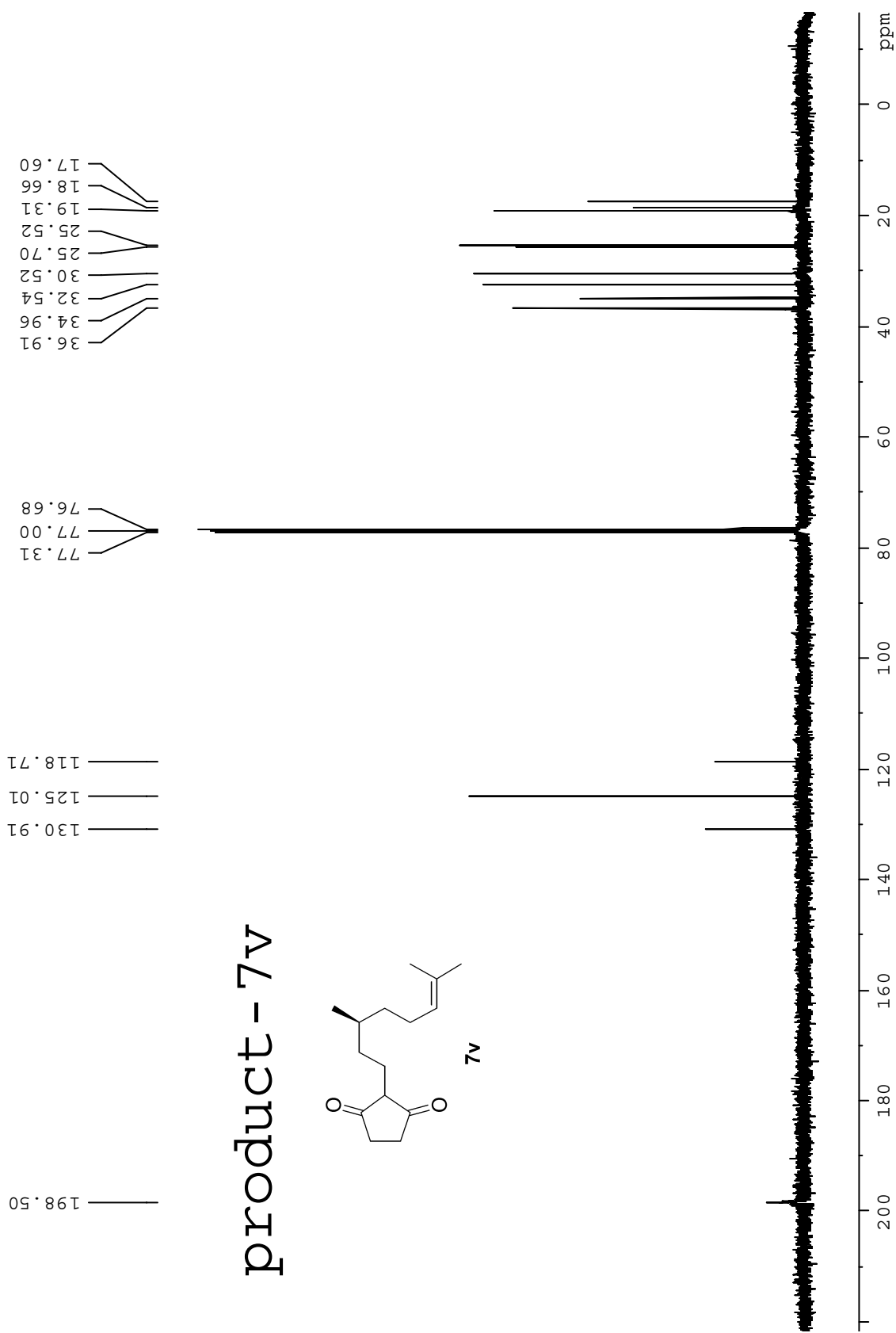

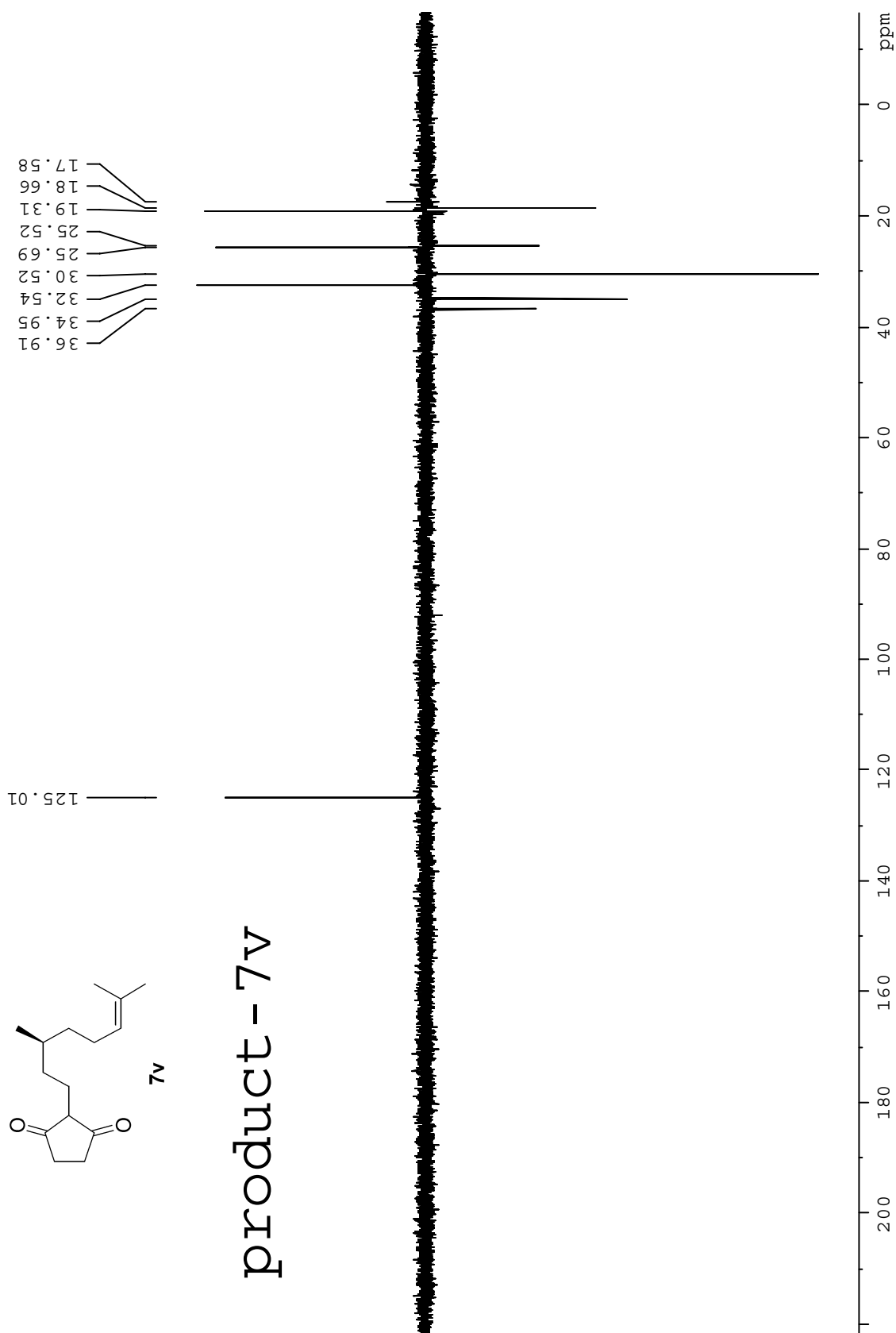

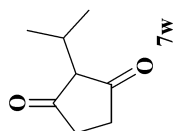

# product - 7w

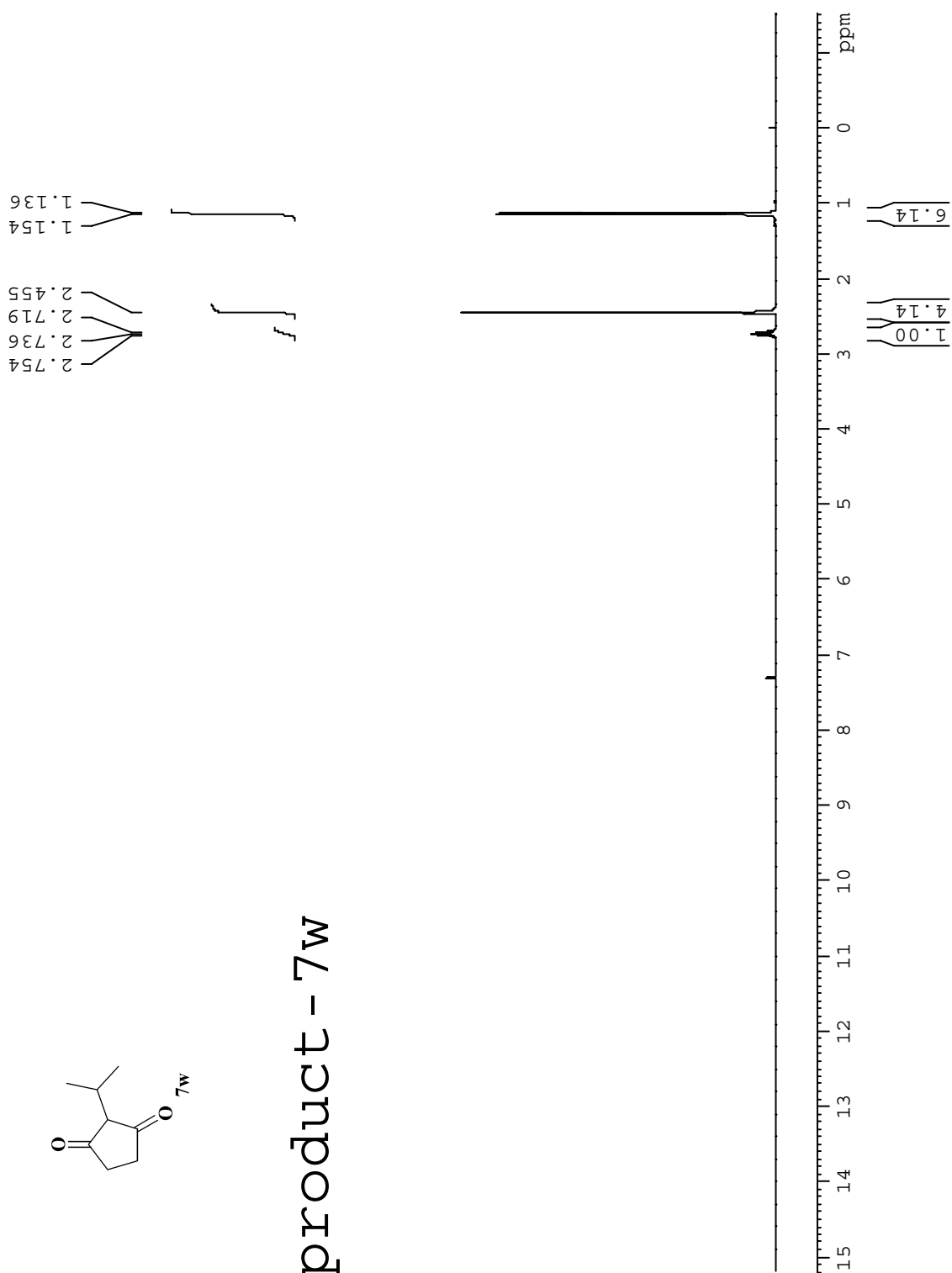

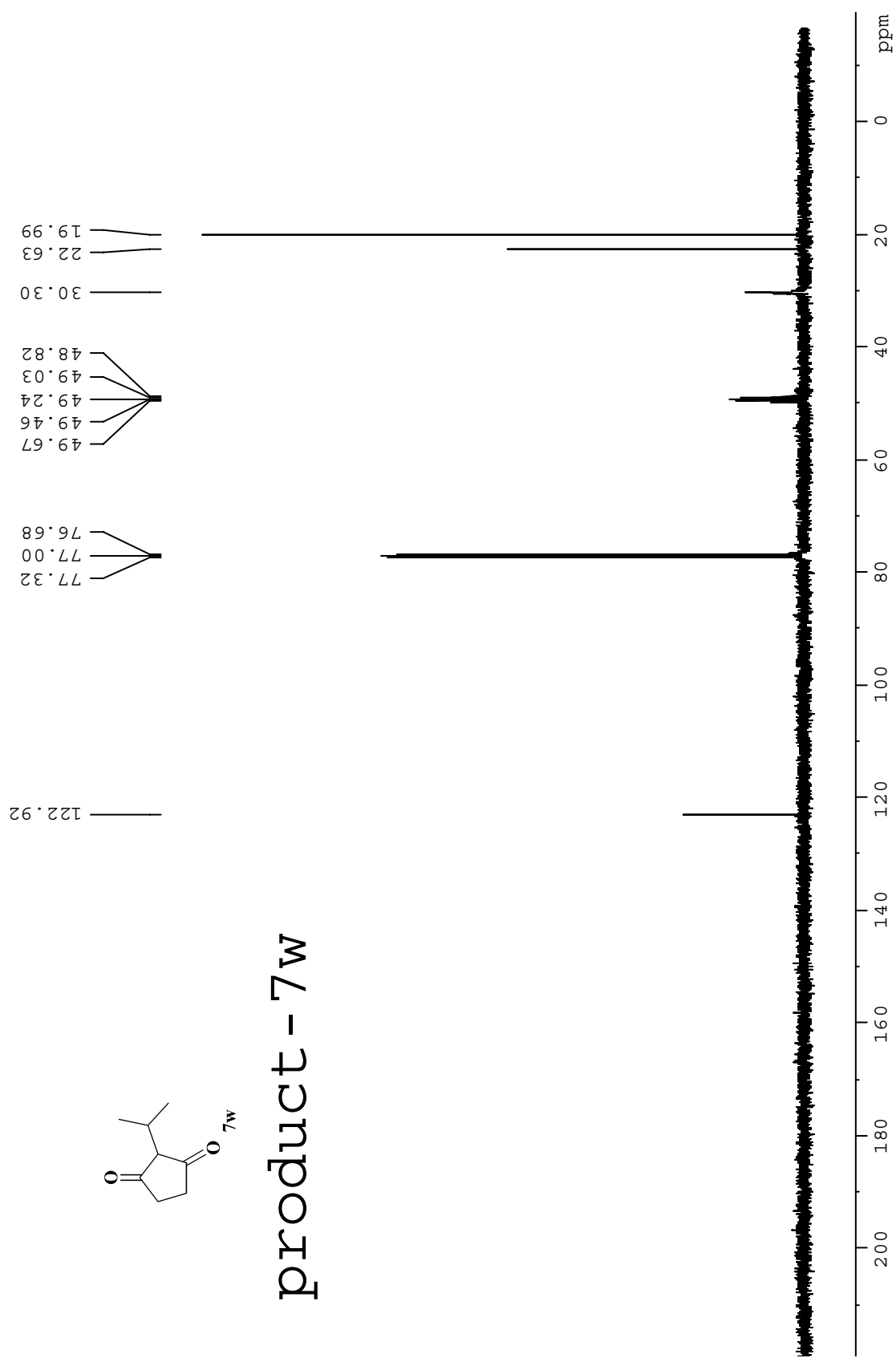

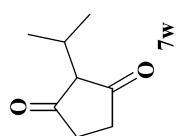

product - 7w

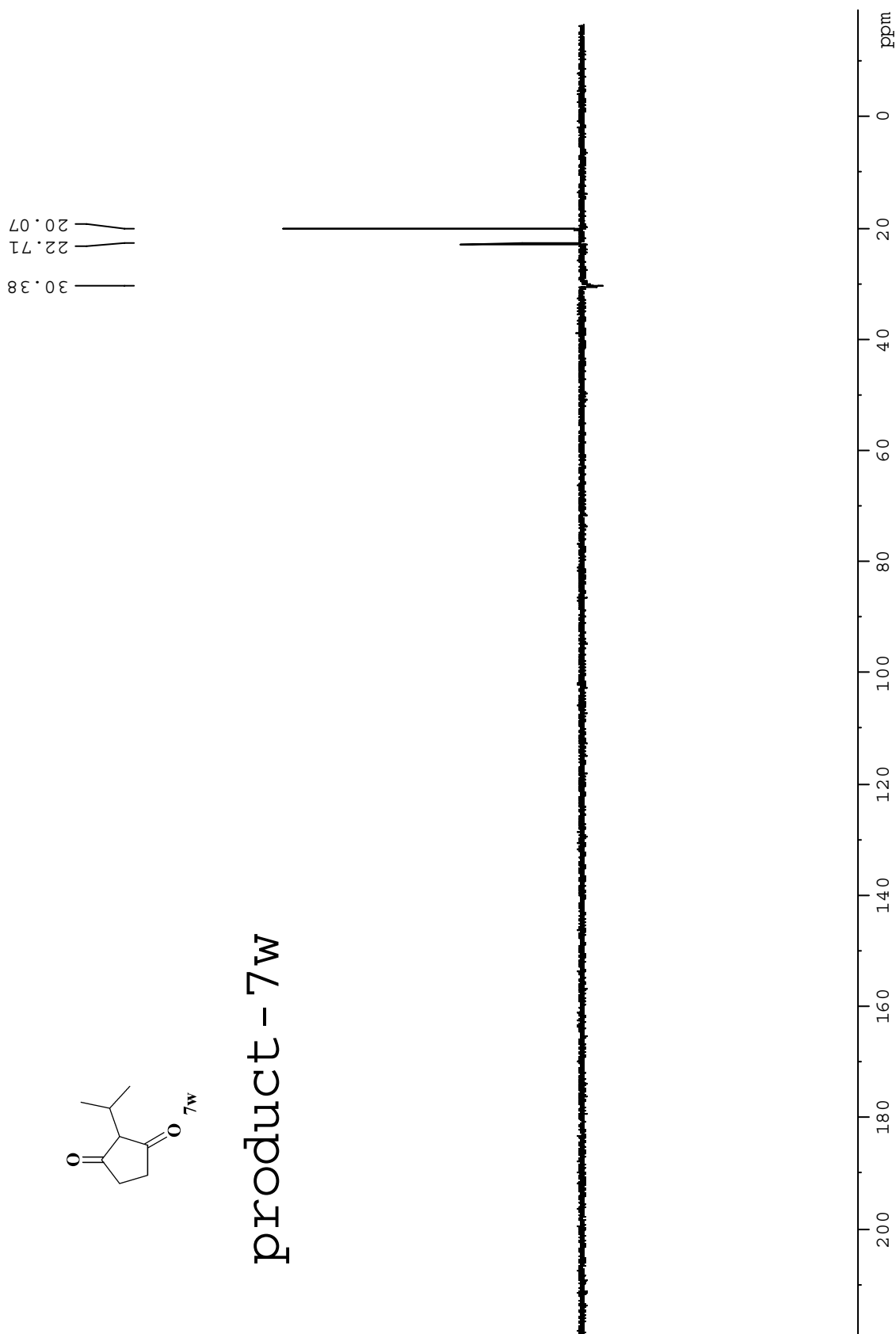

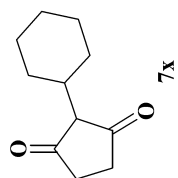

# product - 7x

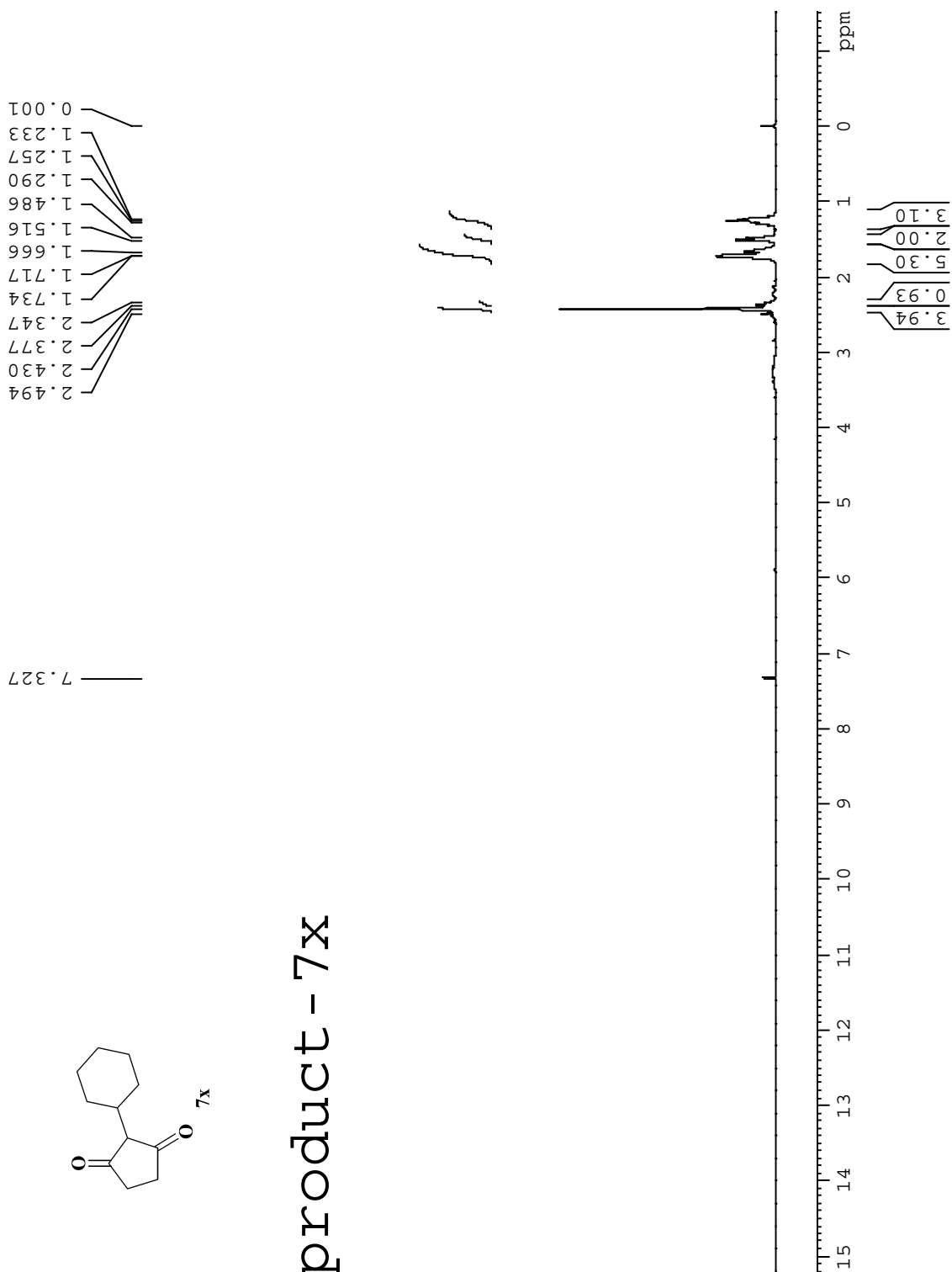

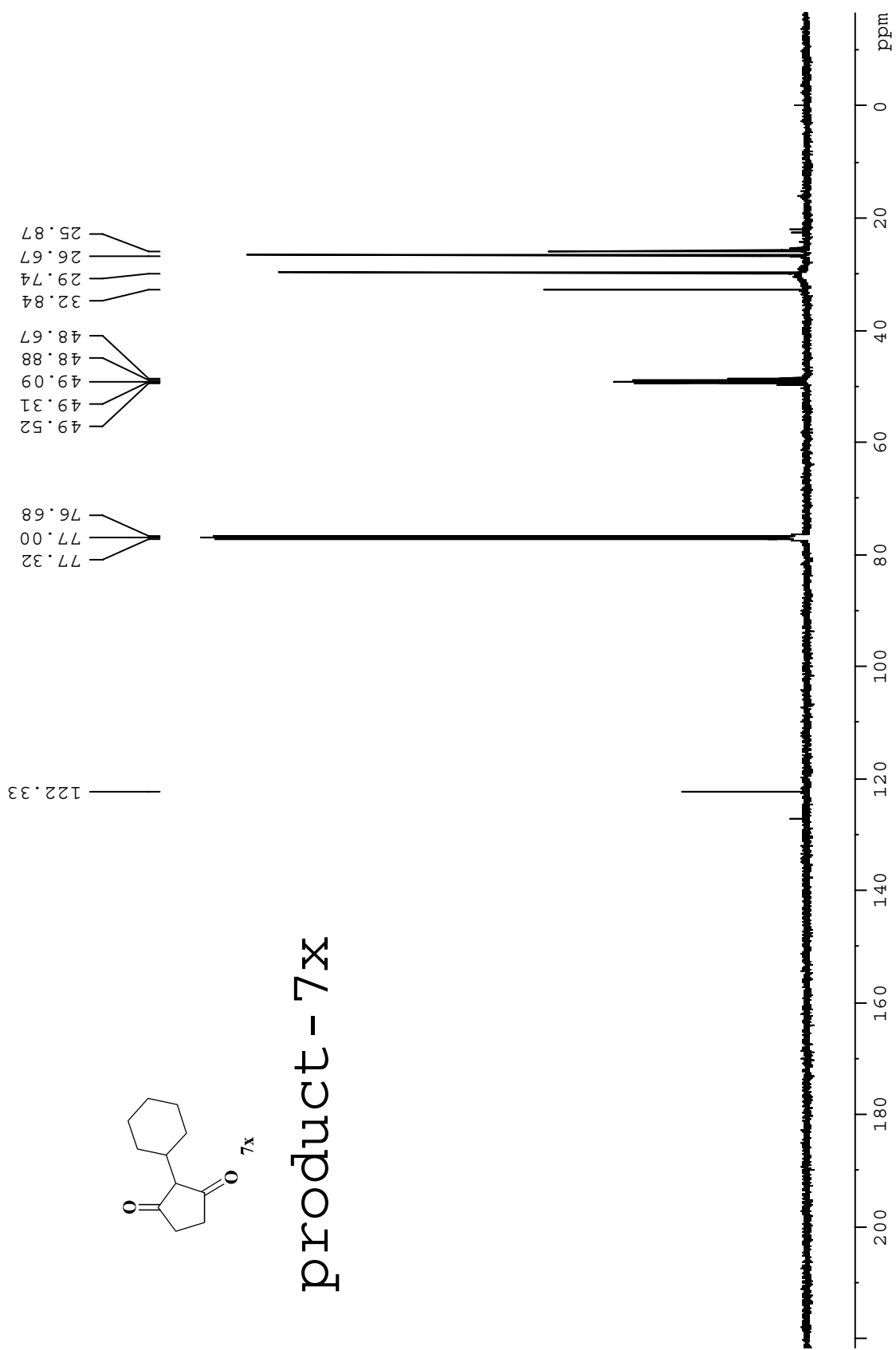



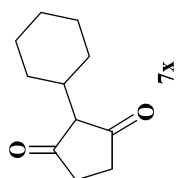

product - 7x

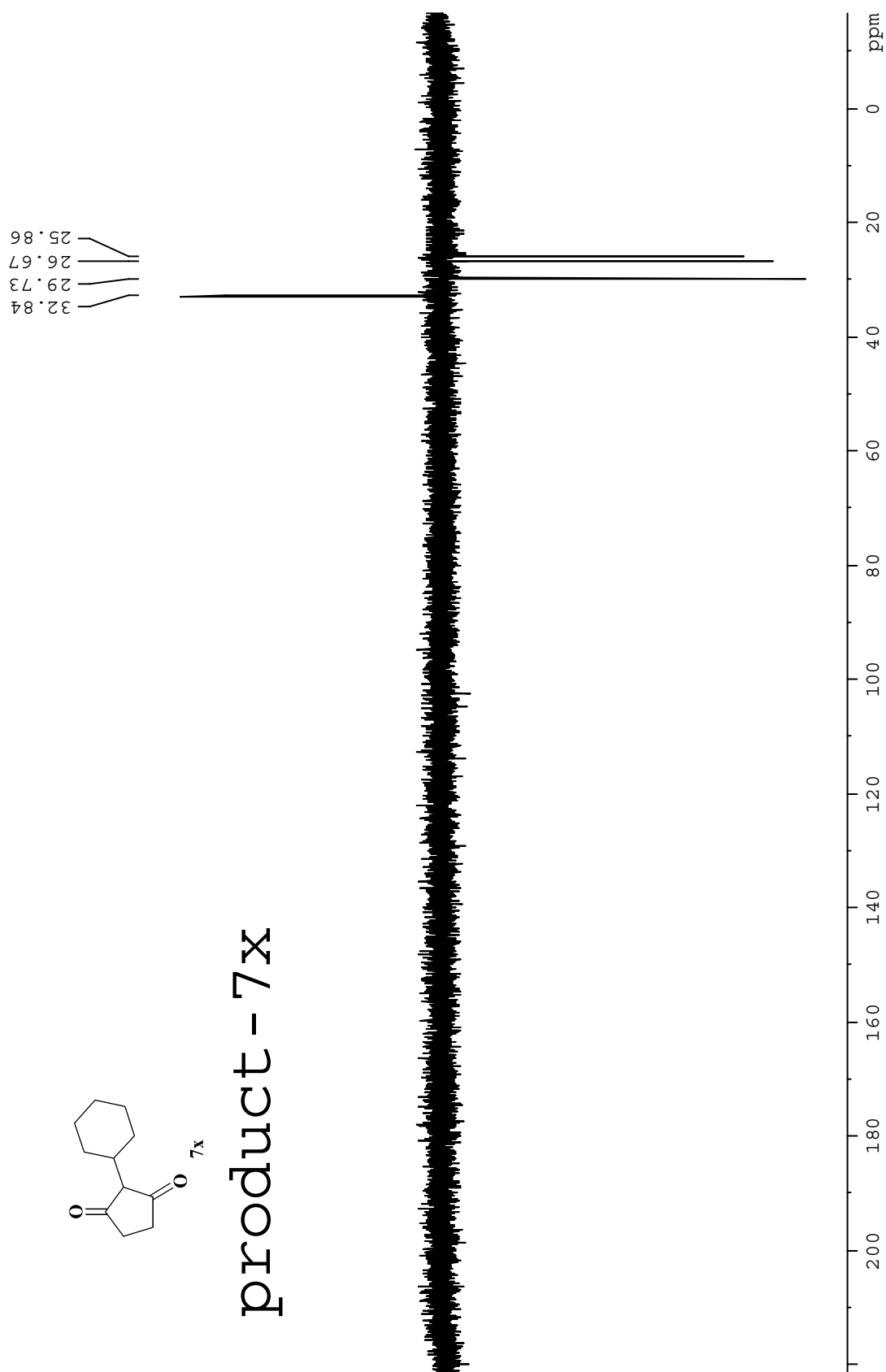

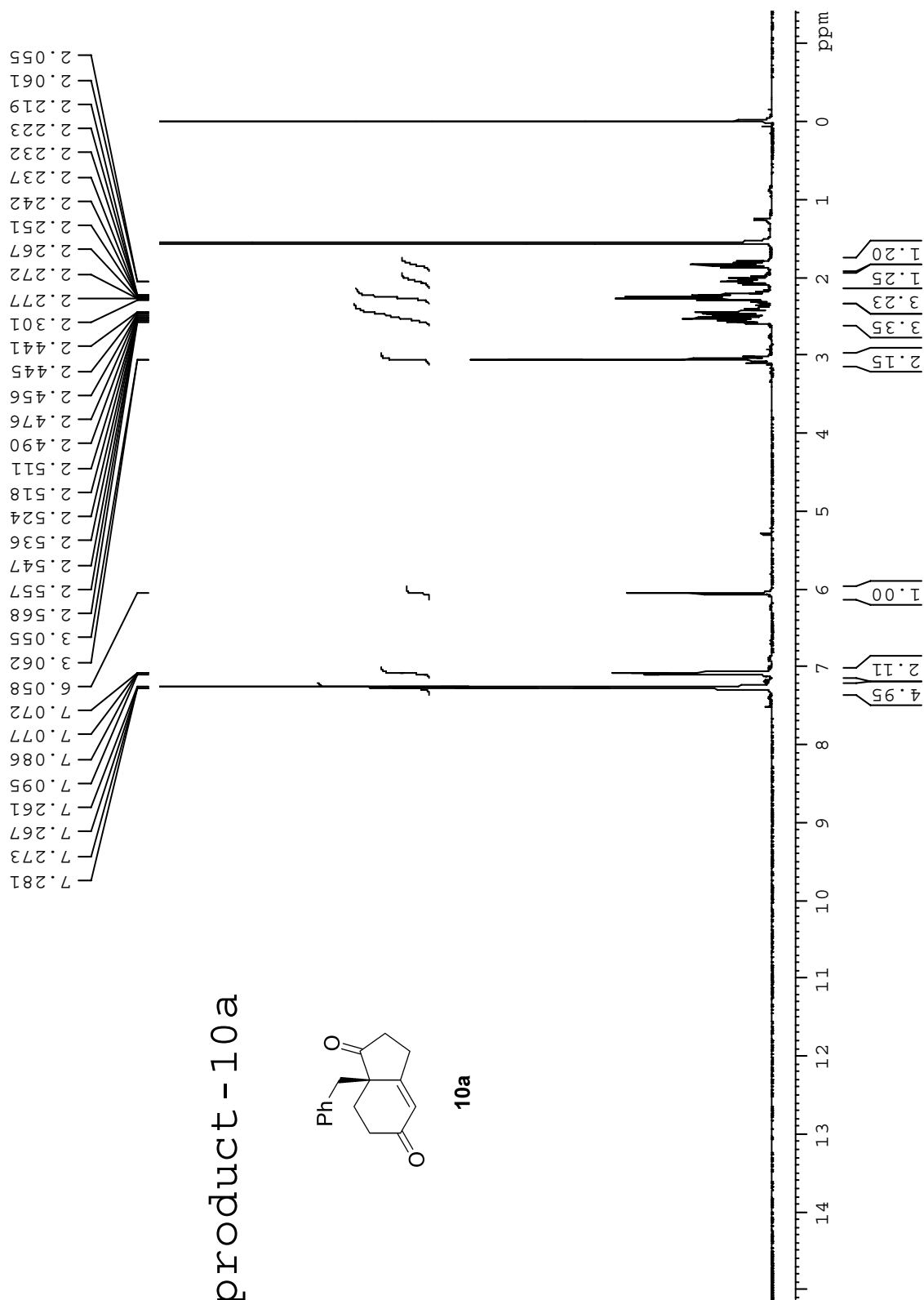

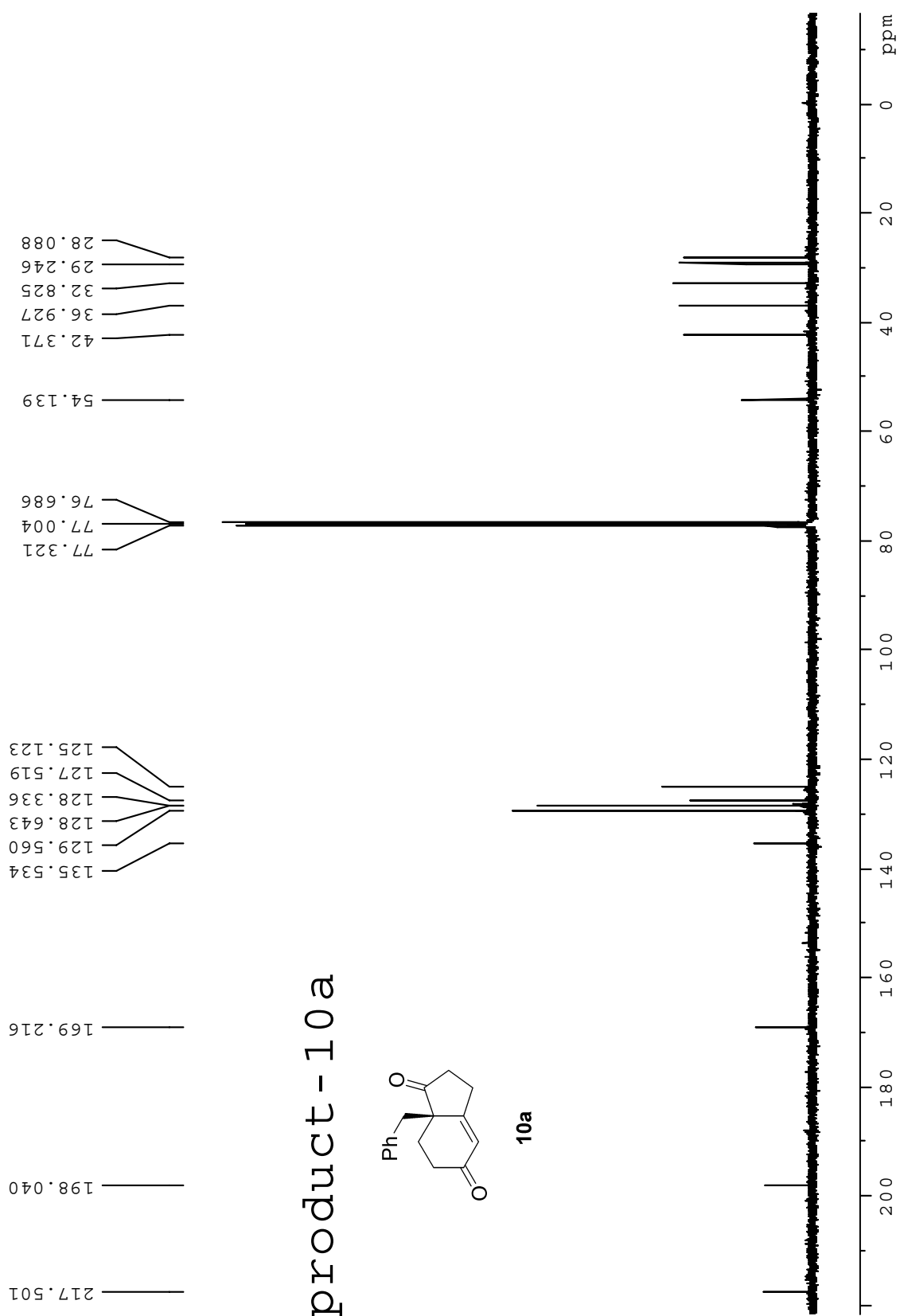

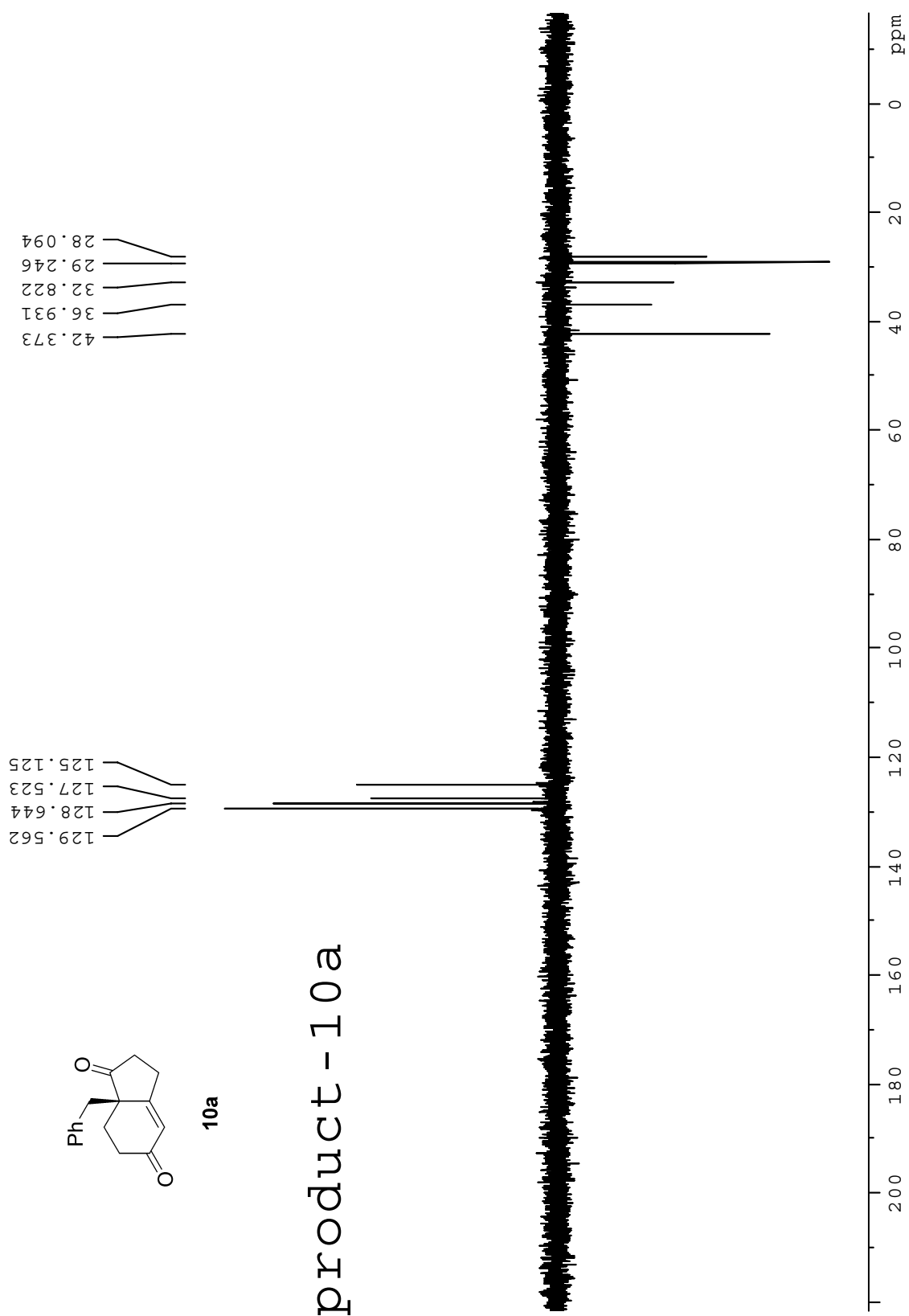

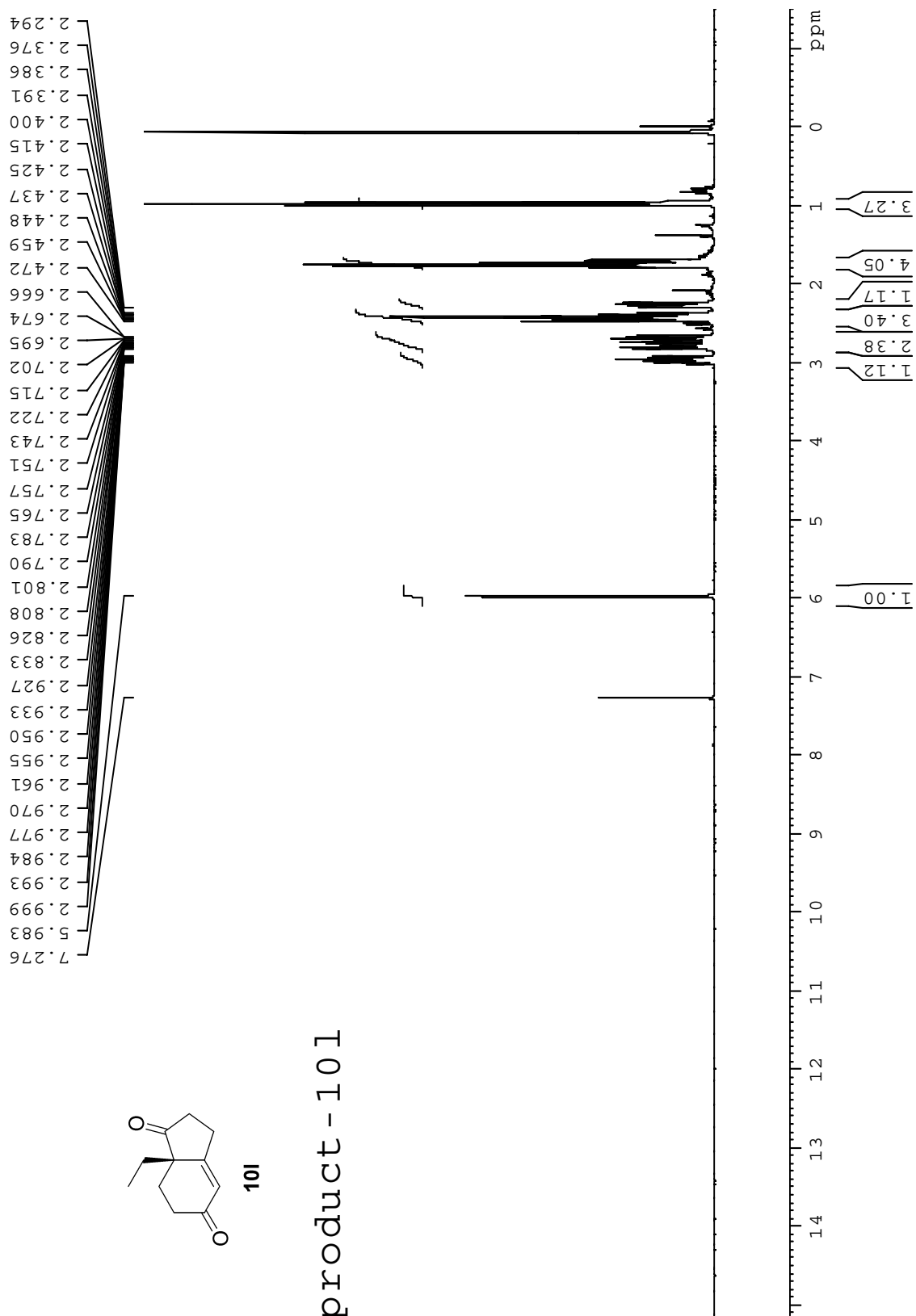

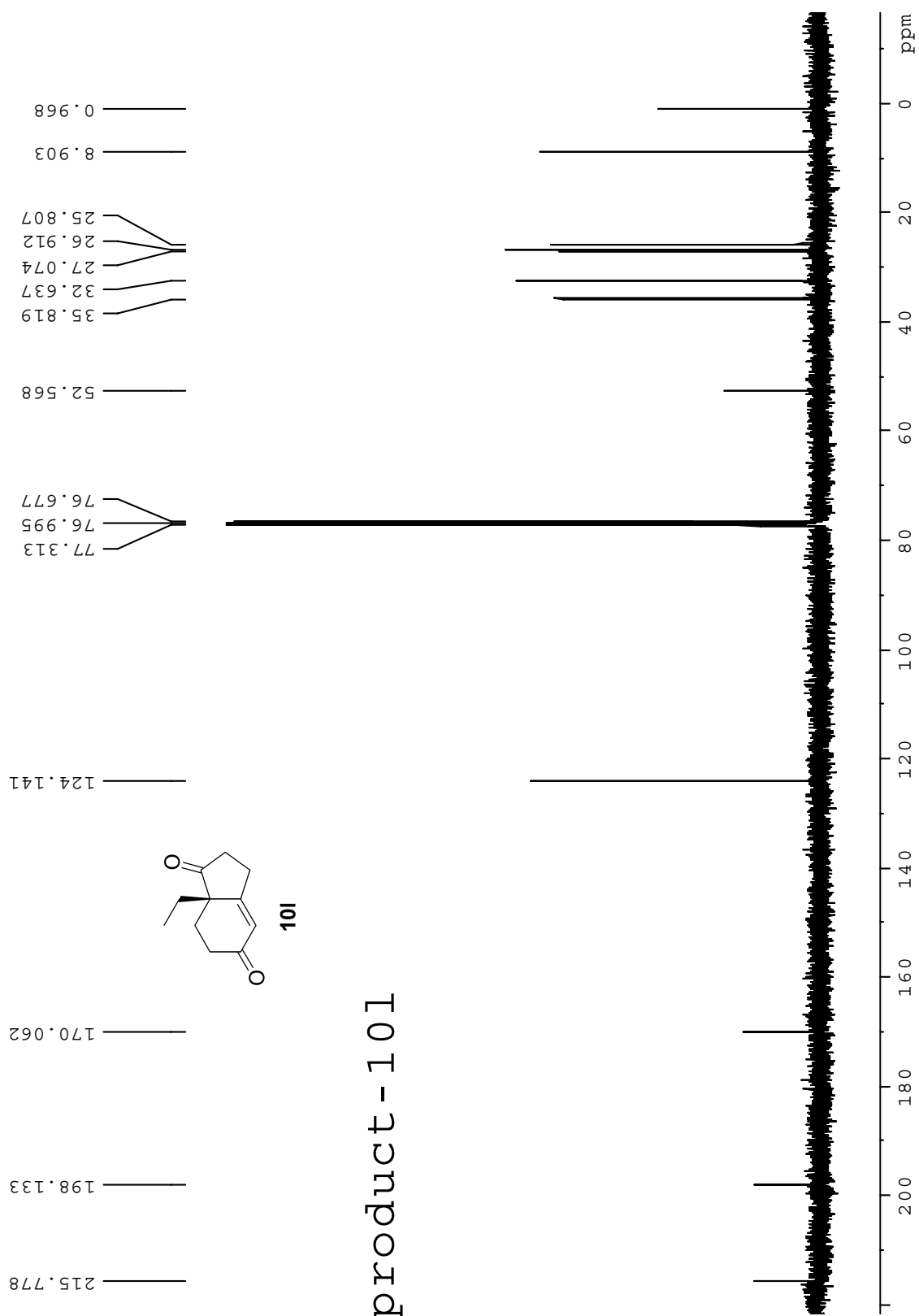

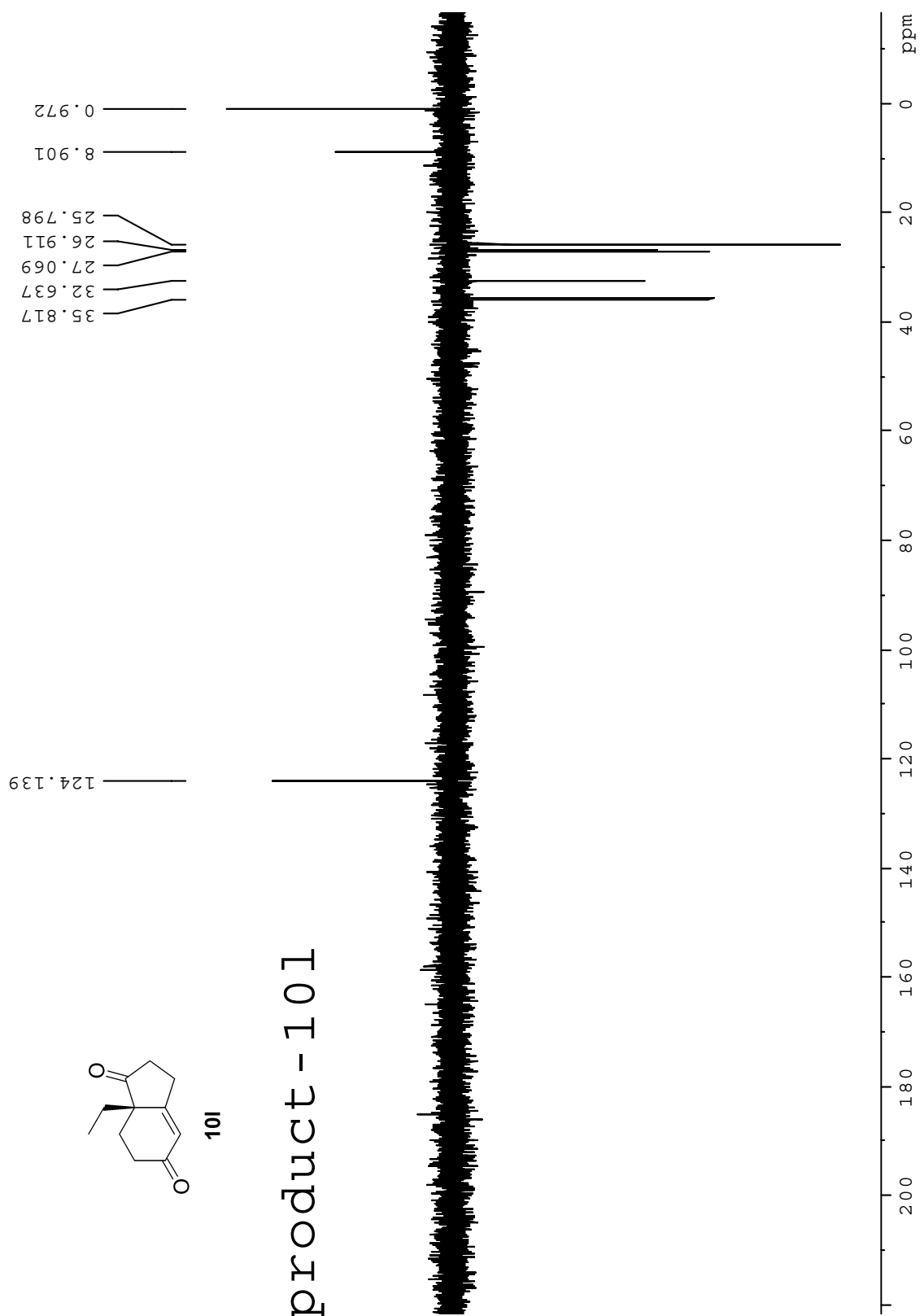

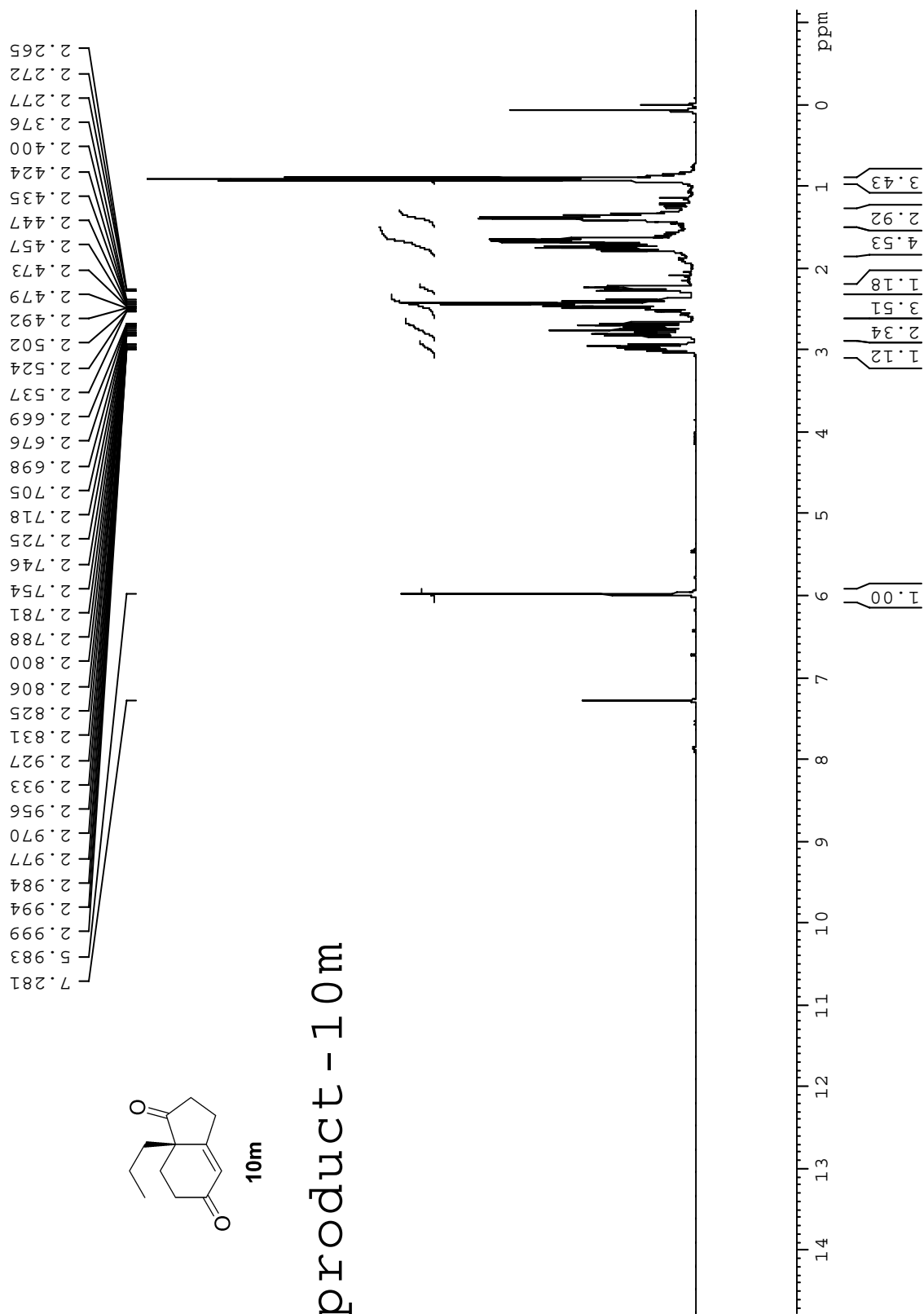



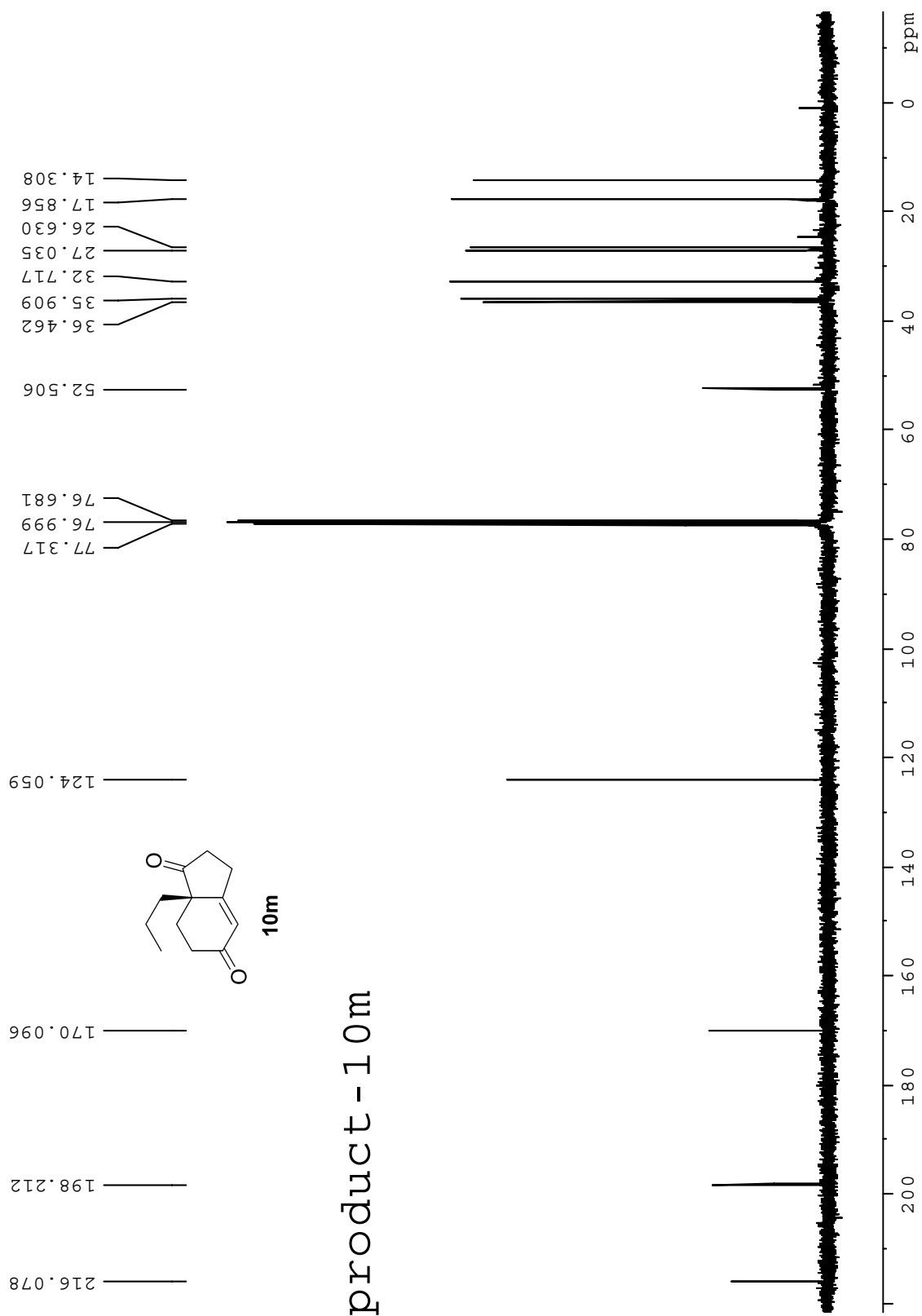

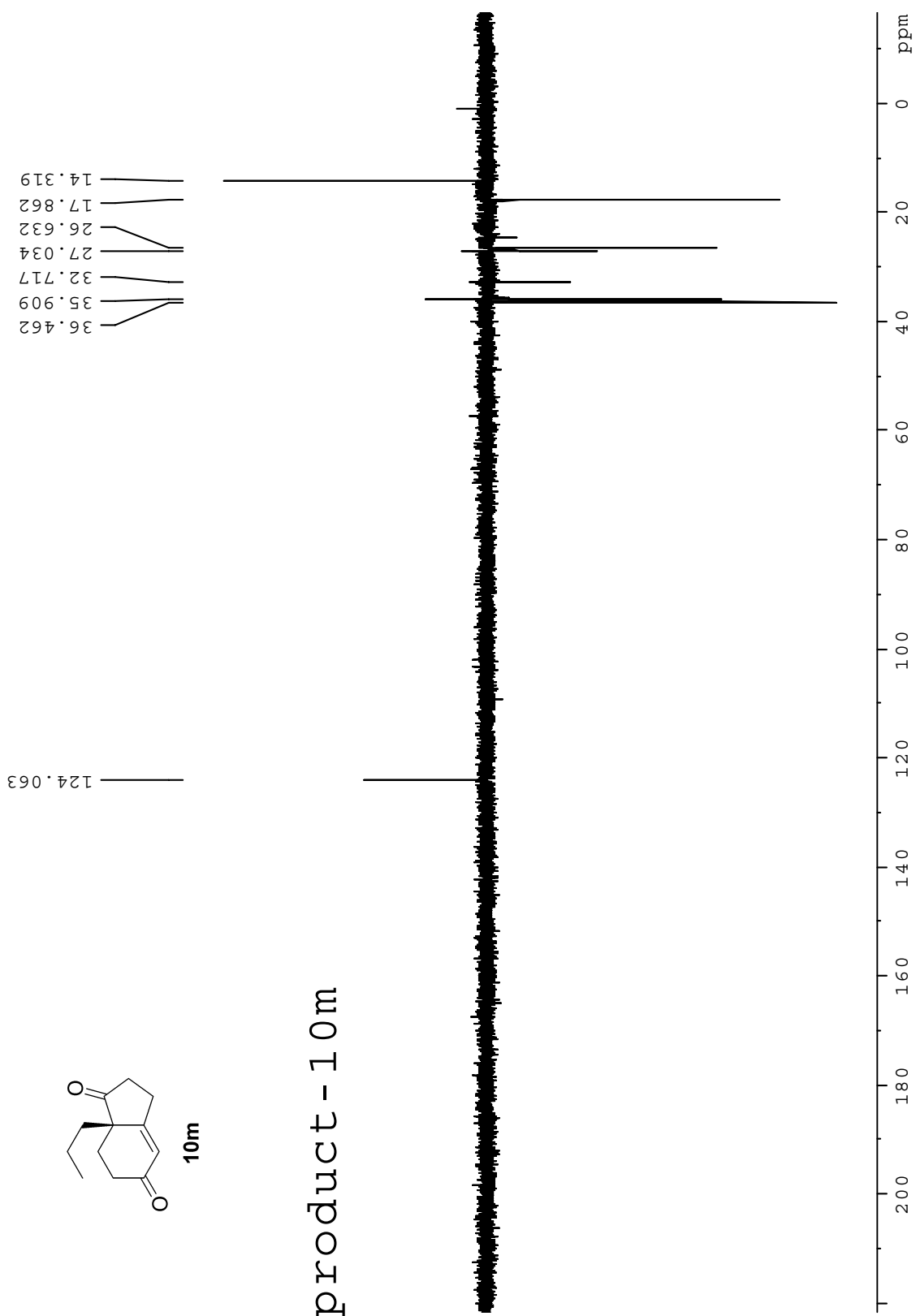

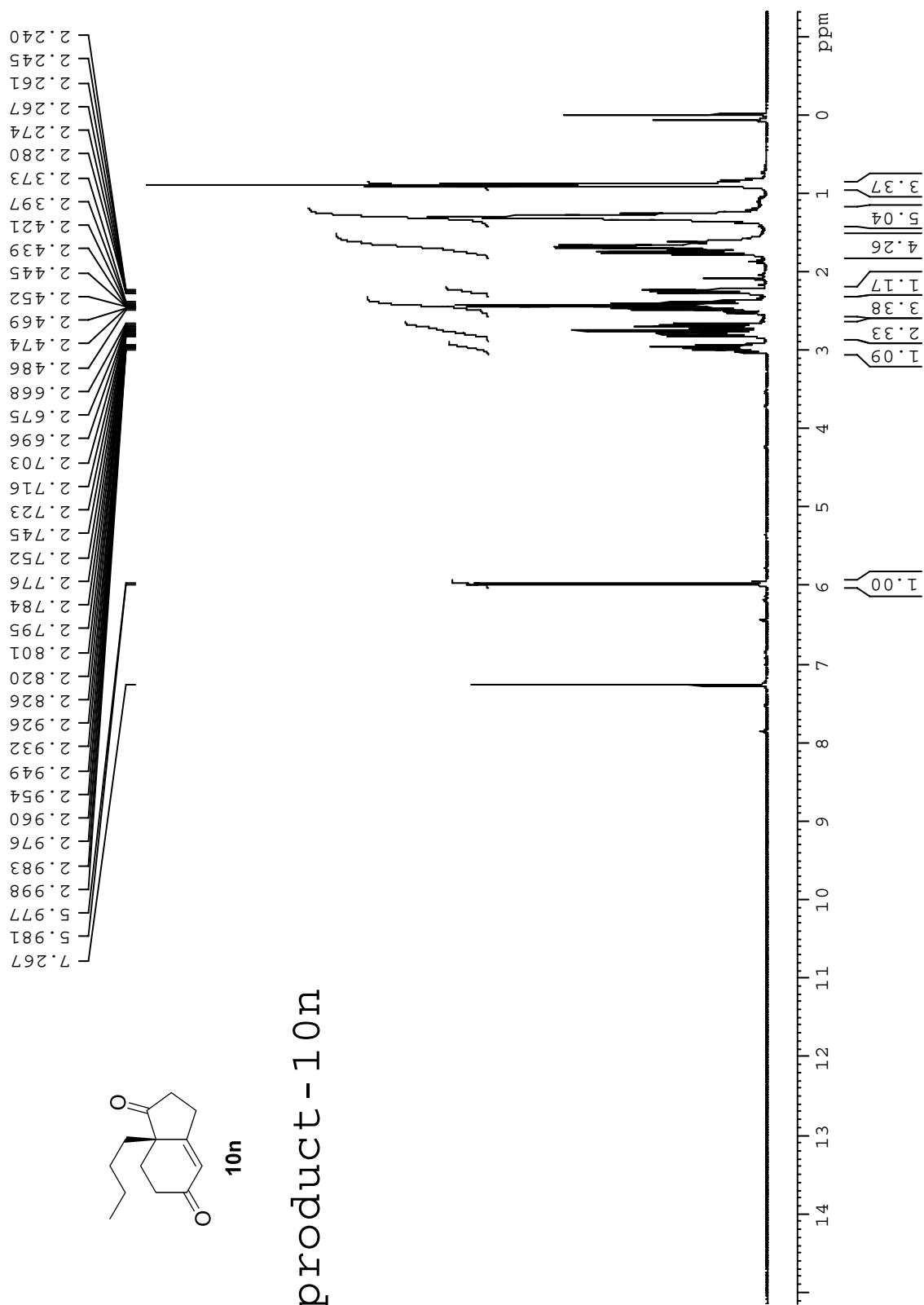

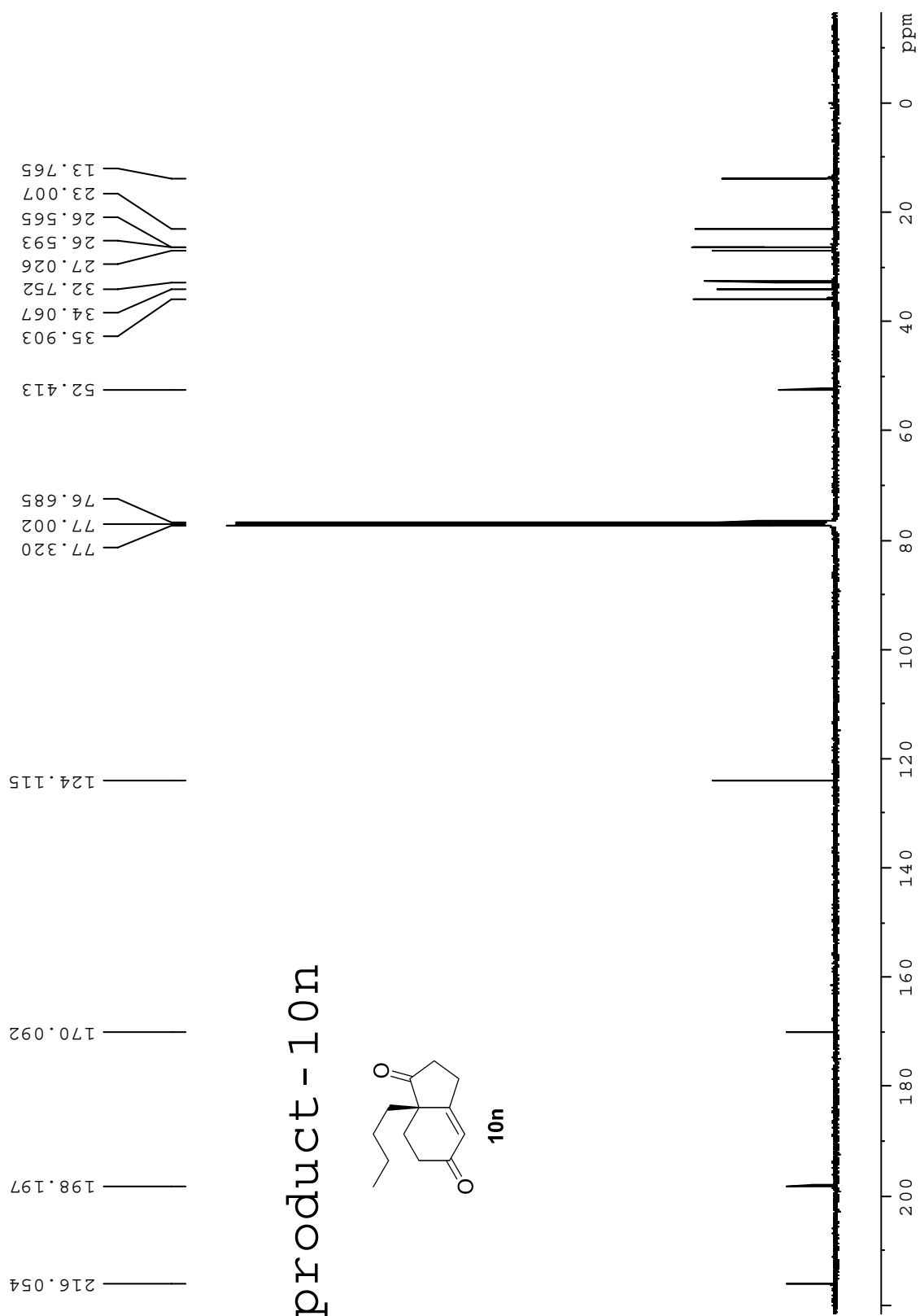

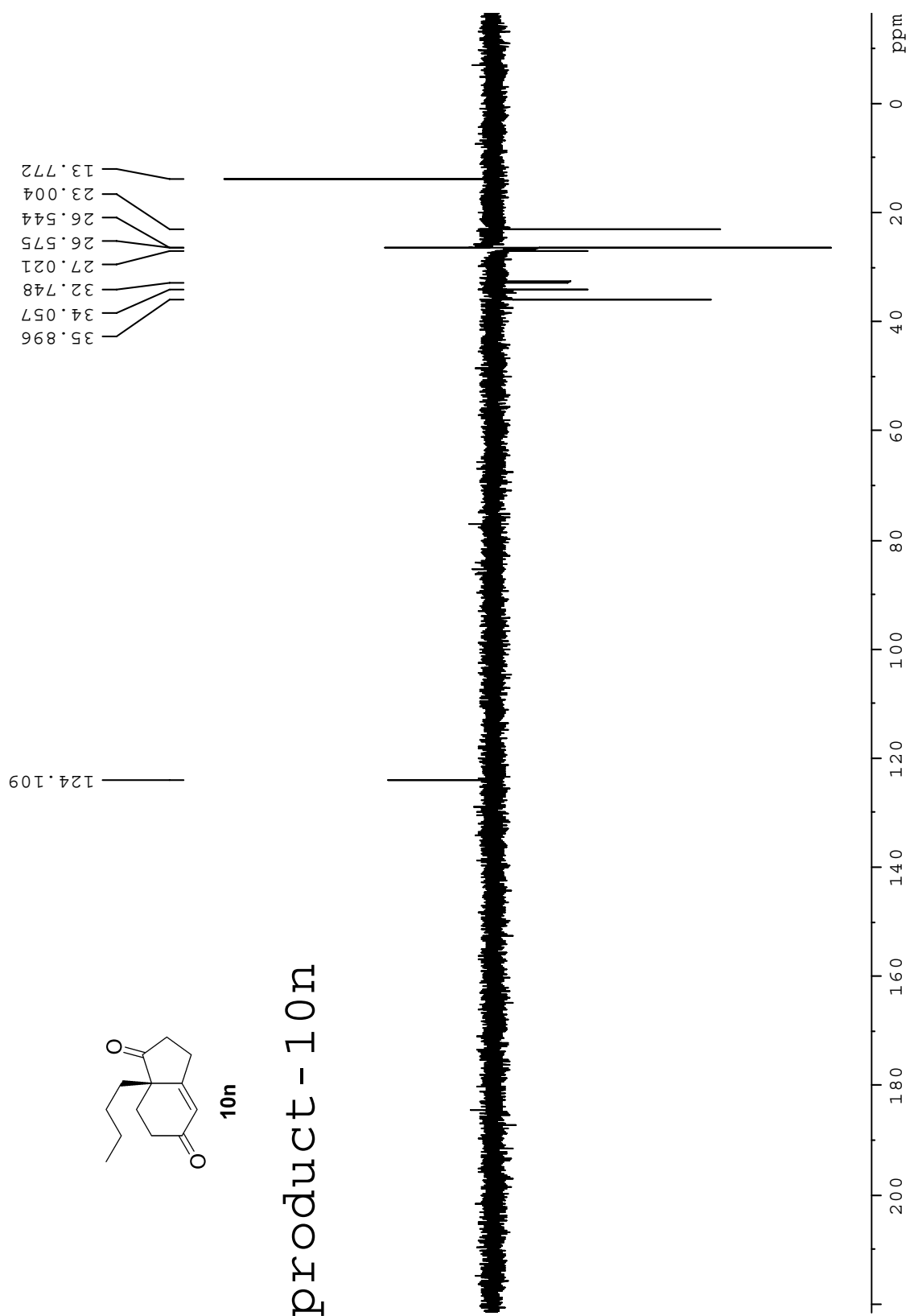

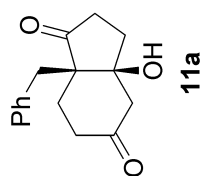

# product - 11a

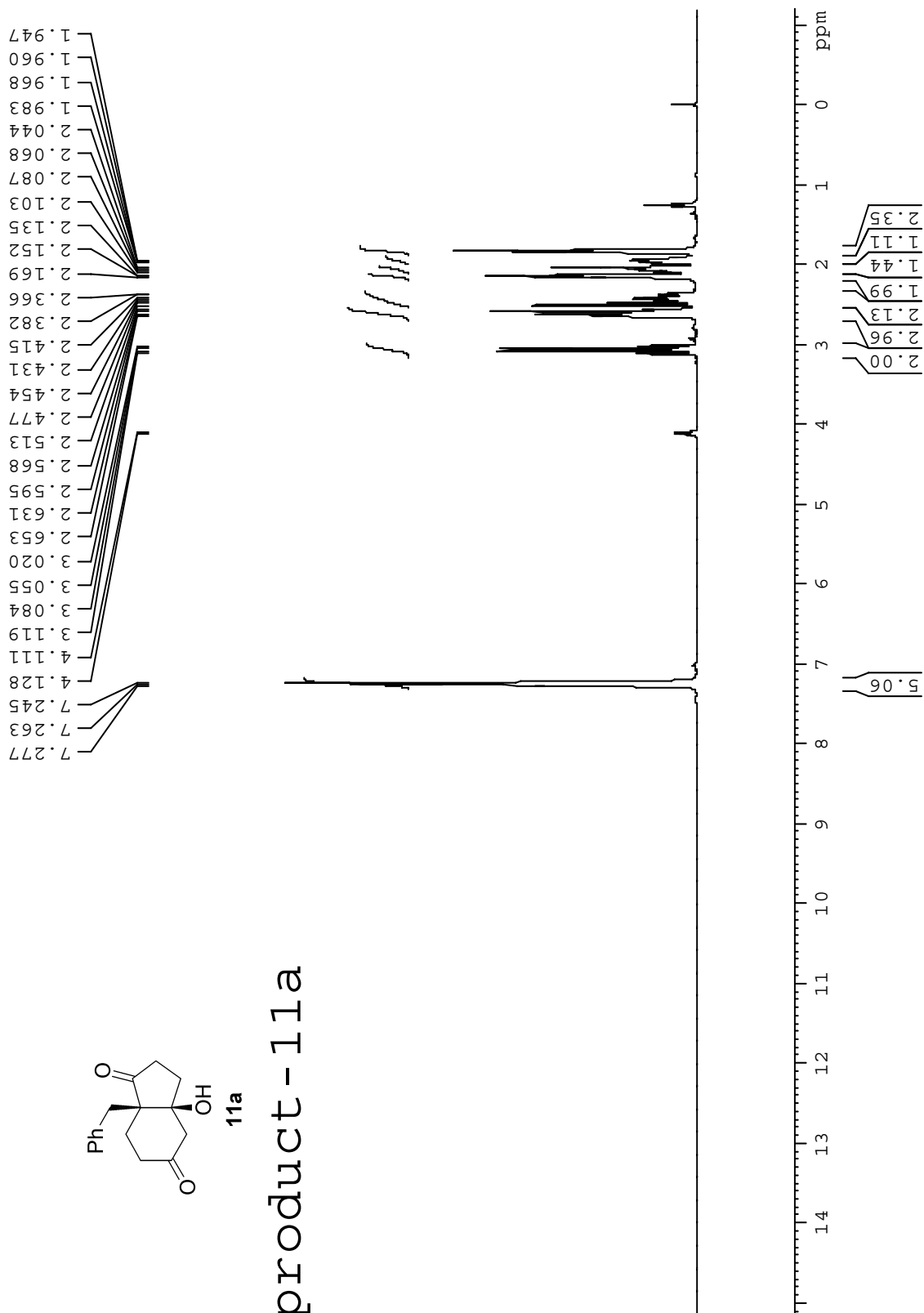

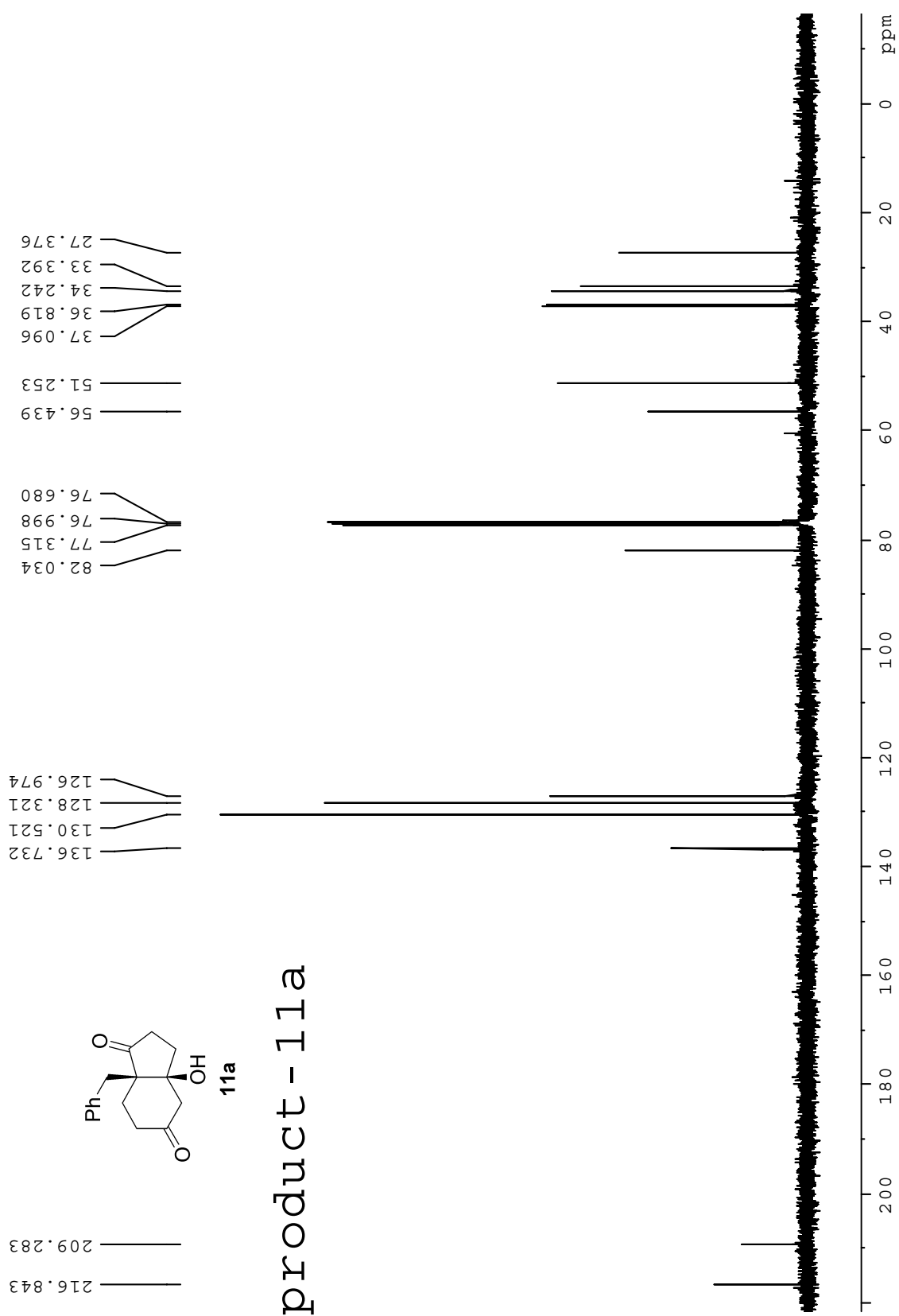

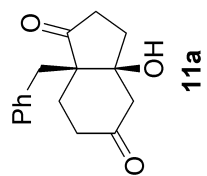

product - 11a

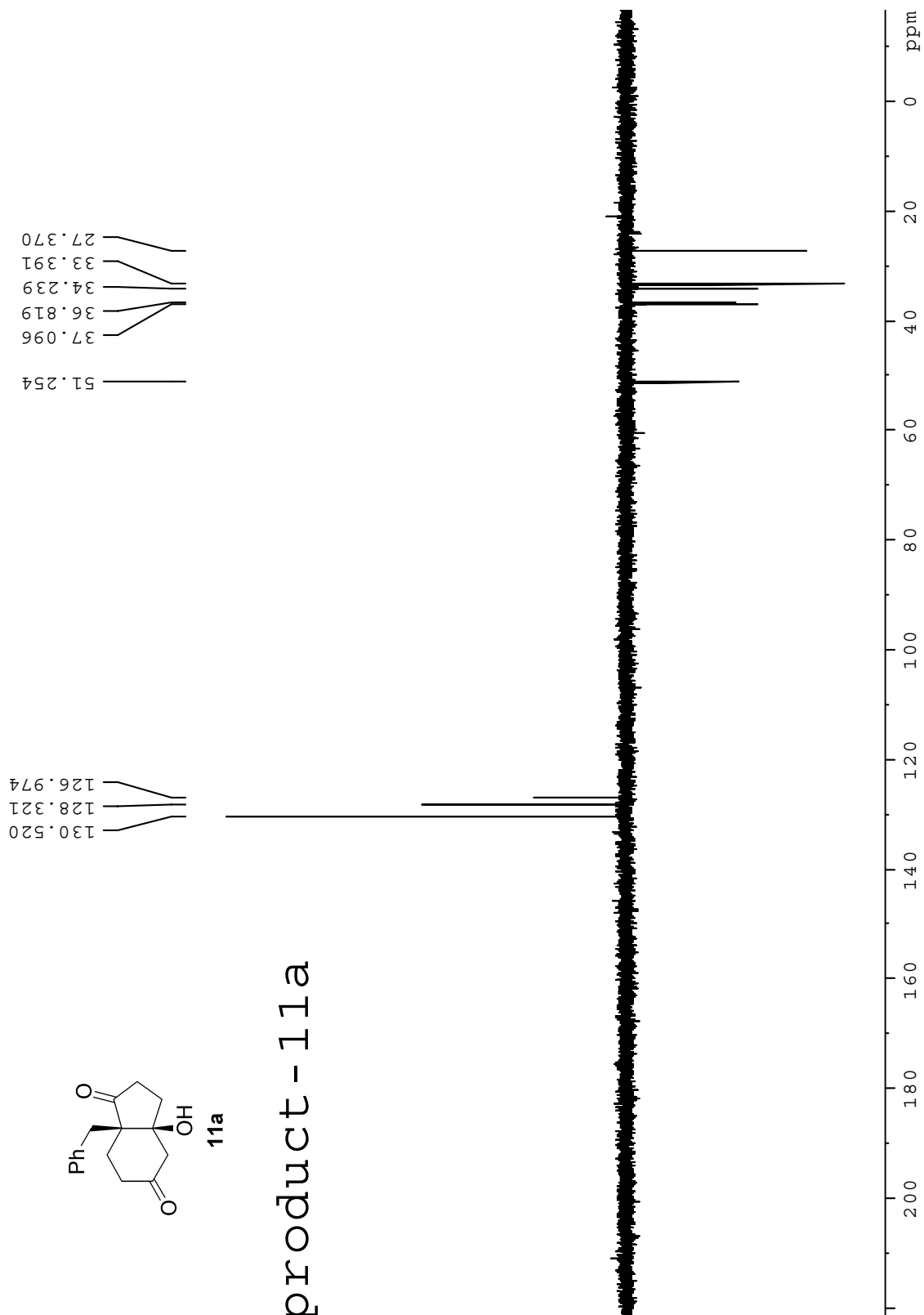



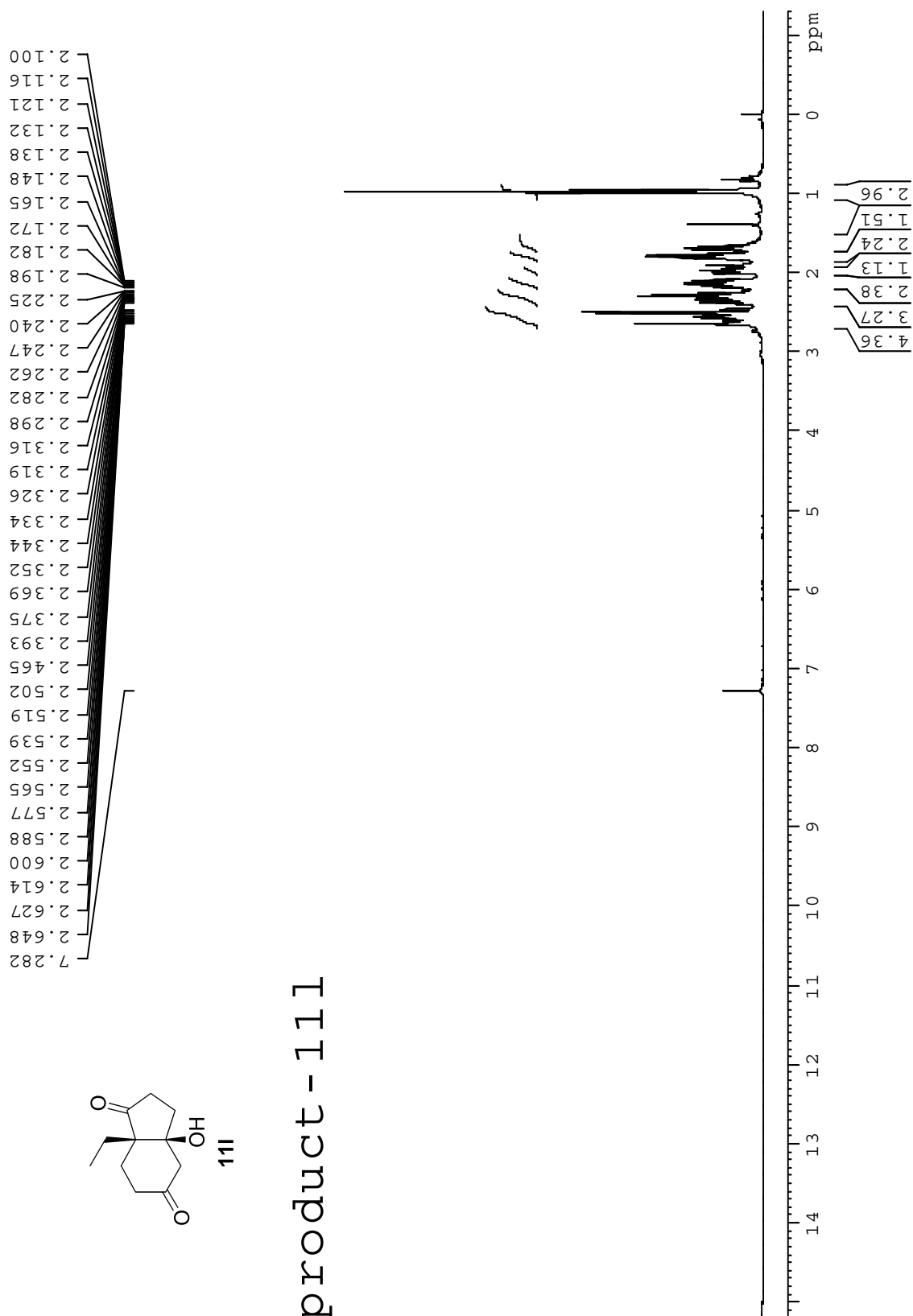

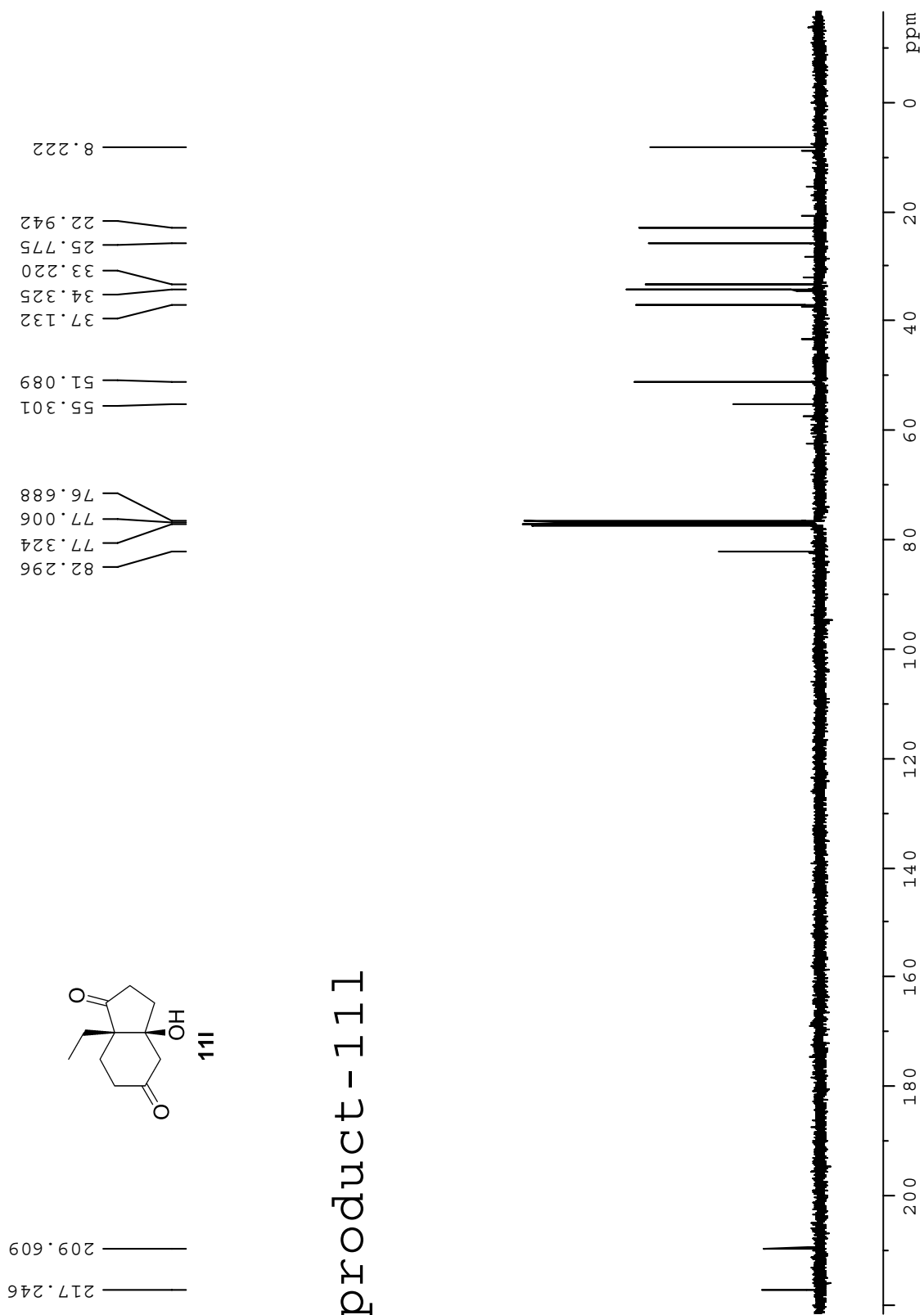

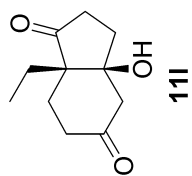

product - 111

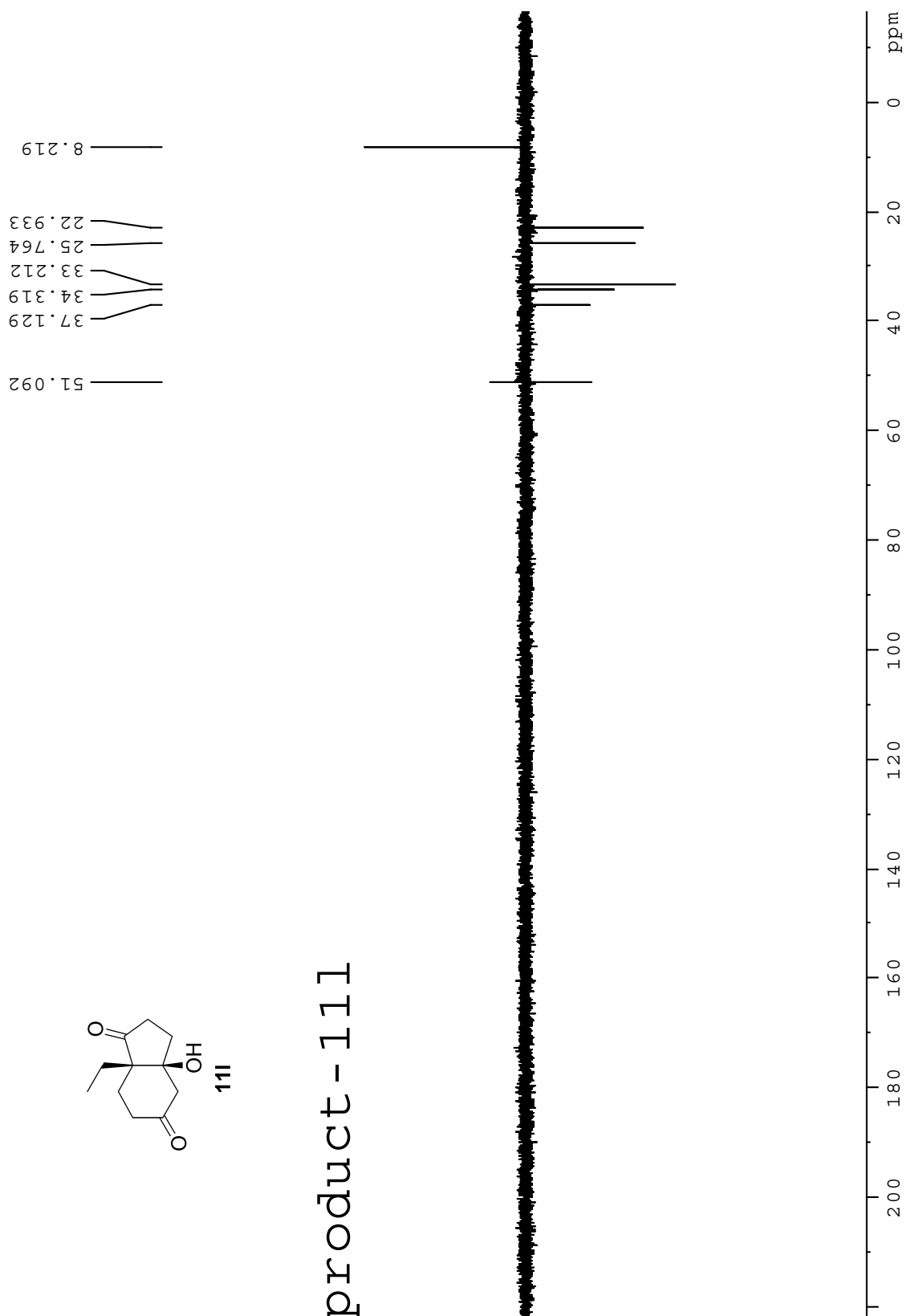

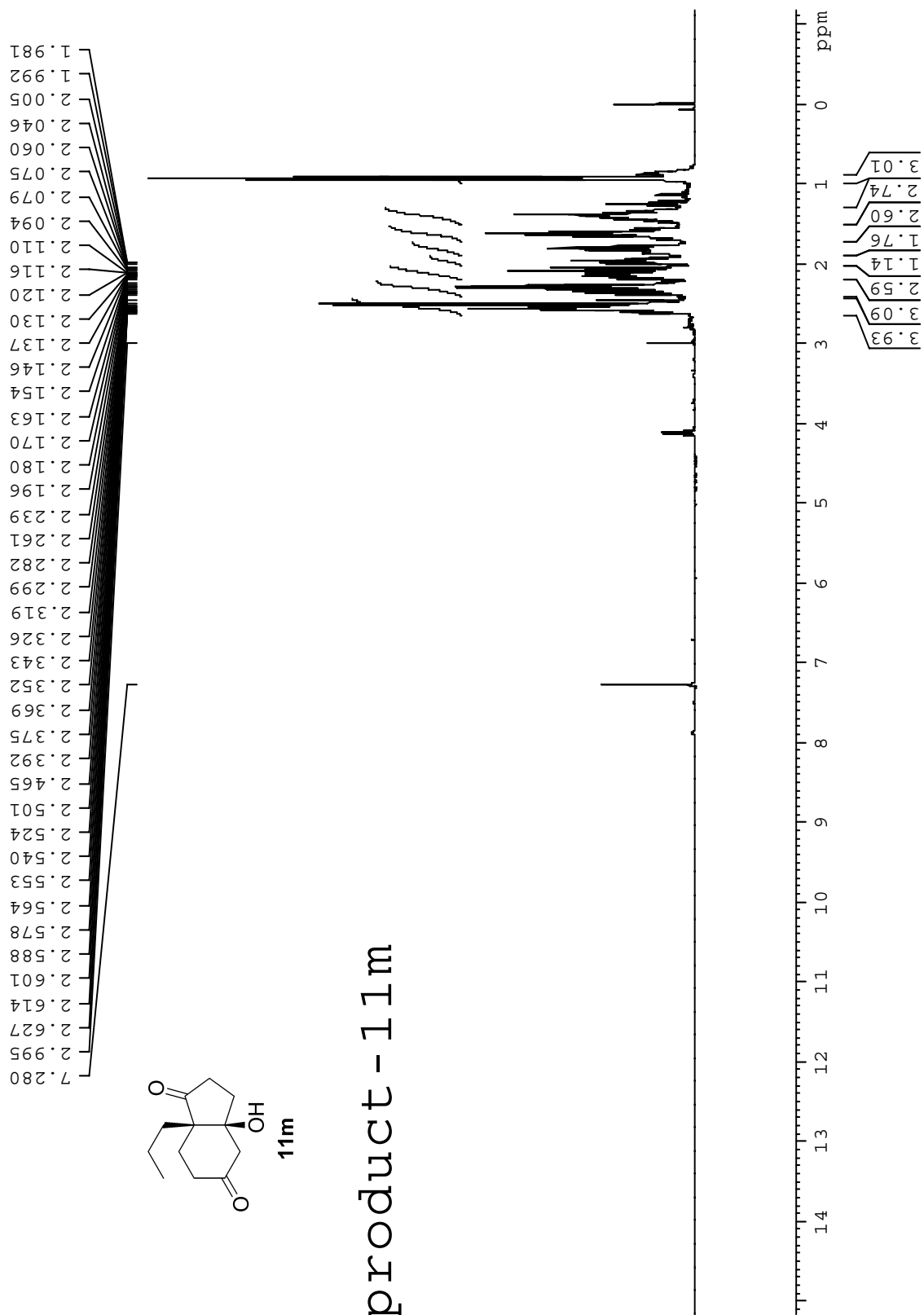

217.349  
209.439

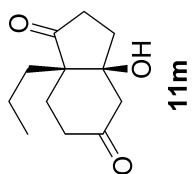

82.272  
77.318  
77.000  
76.683  
55.294  
51.036  
37.153  
34.303  
33.207  
32.482  
26.397  
17.056  
14.780

product - 11m

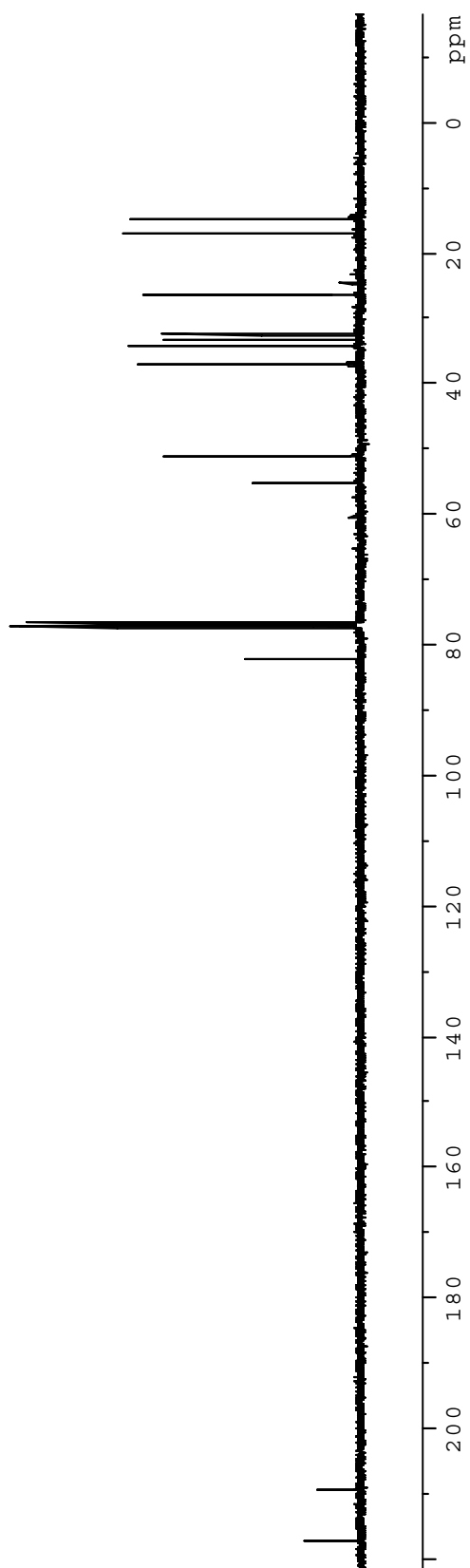

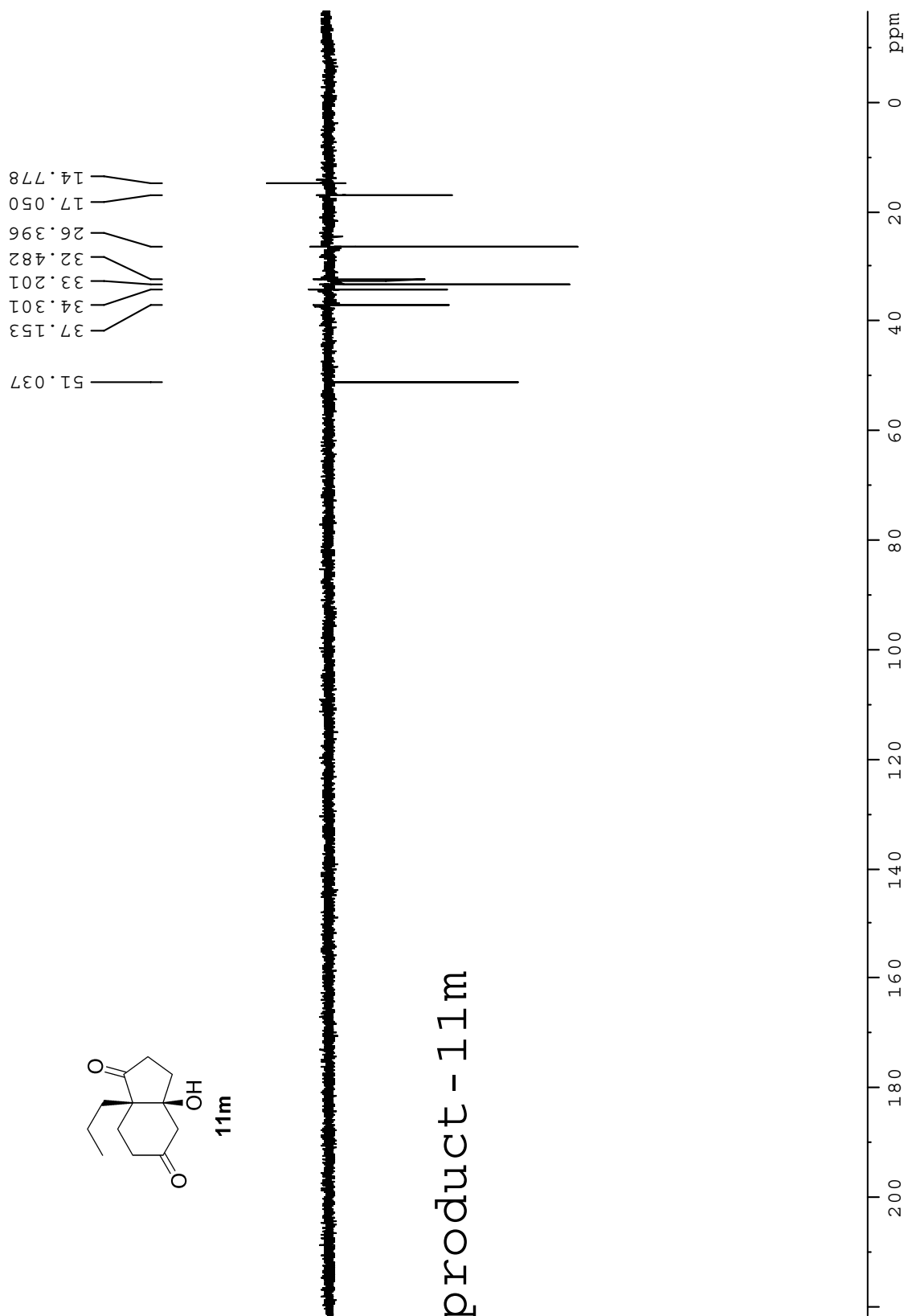
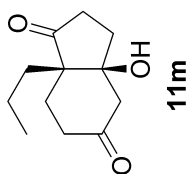

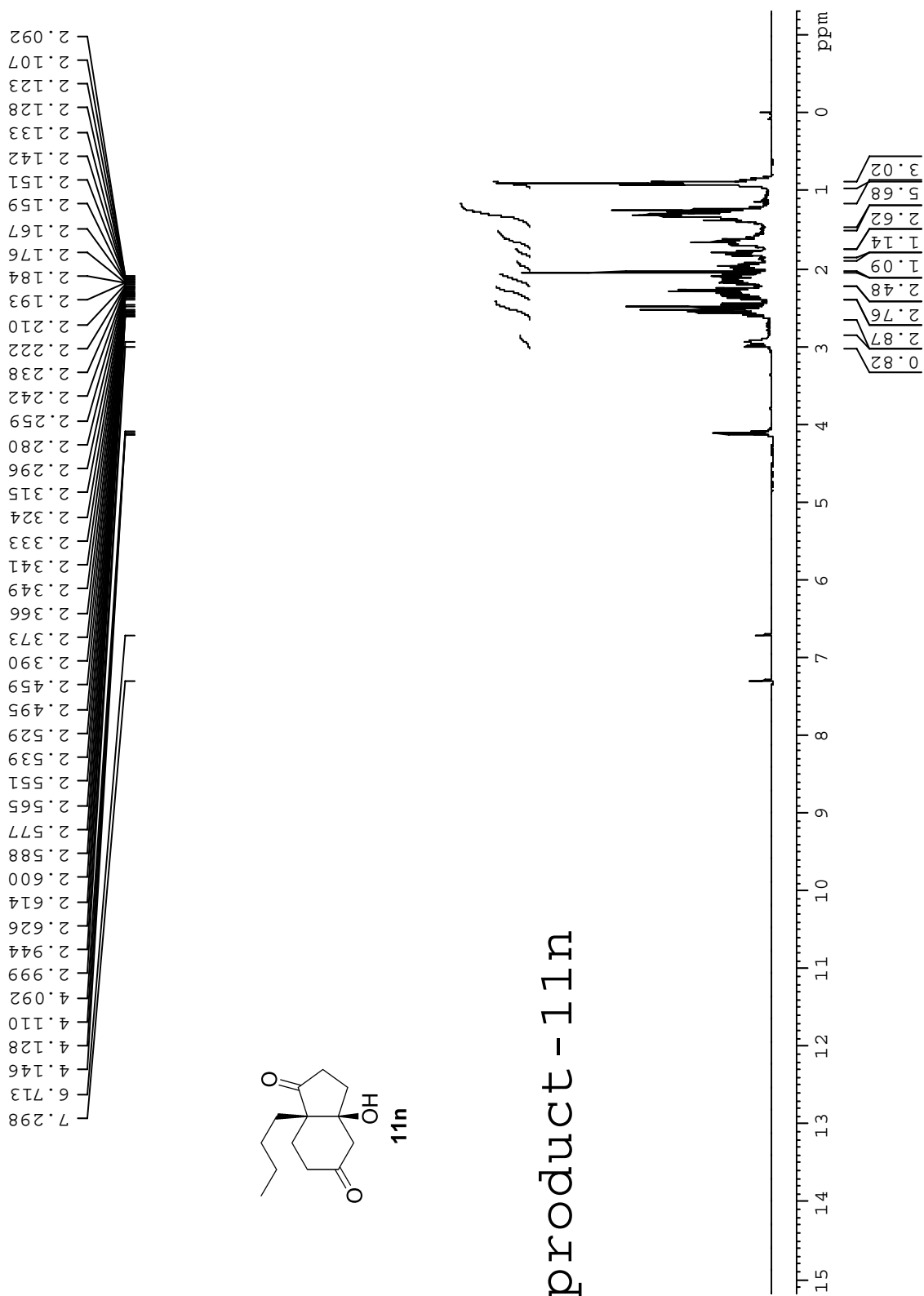

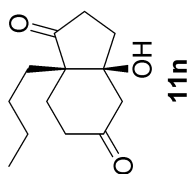

217.383  
209.650

82.251  
77.317  
77.000  
76.682  
55.205  
51.031  
37.160  
34.296  
33.161  
30.011  
26.348  
25.804  
23.400  
13.863

# product - 11n

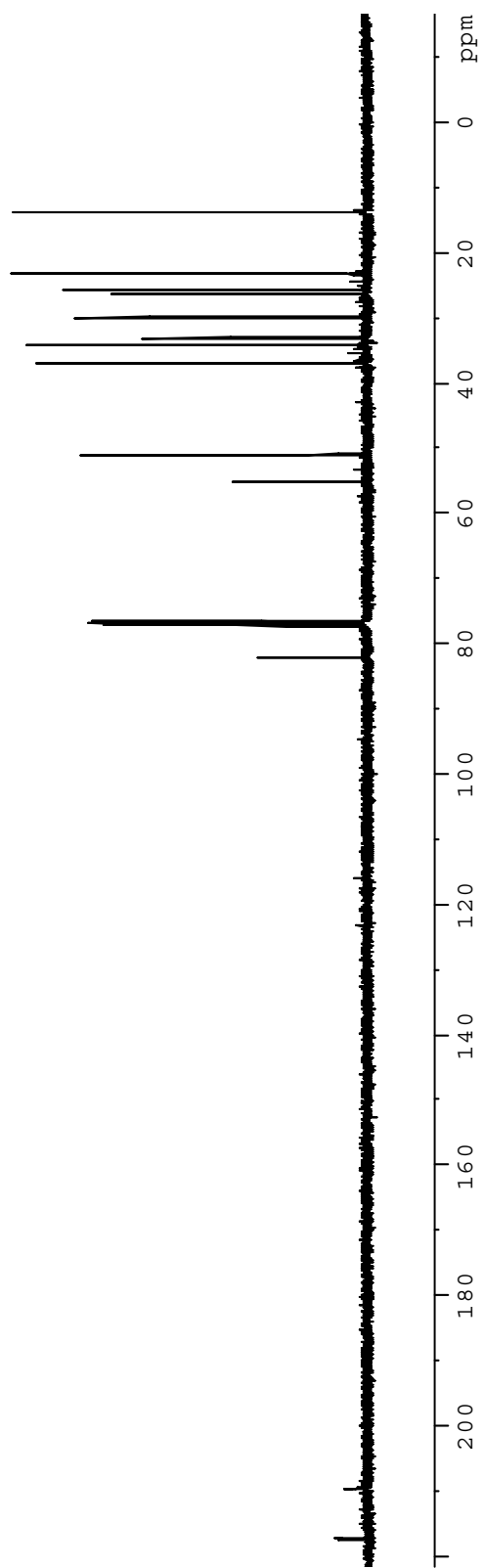



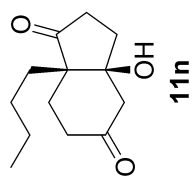

product - 11n

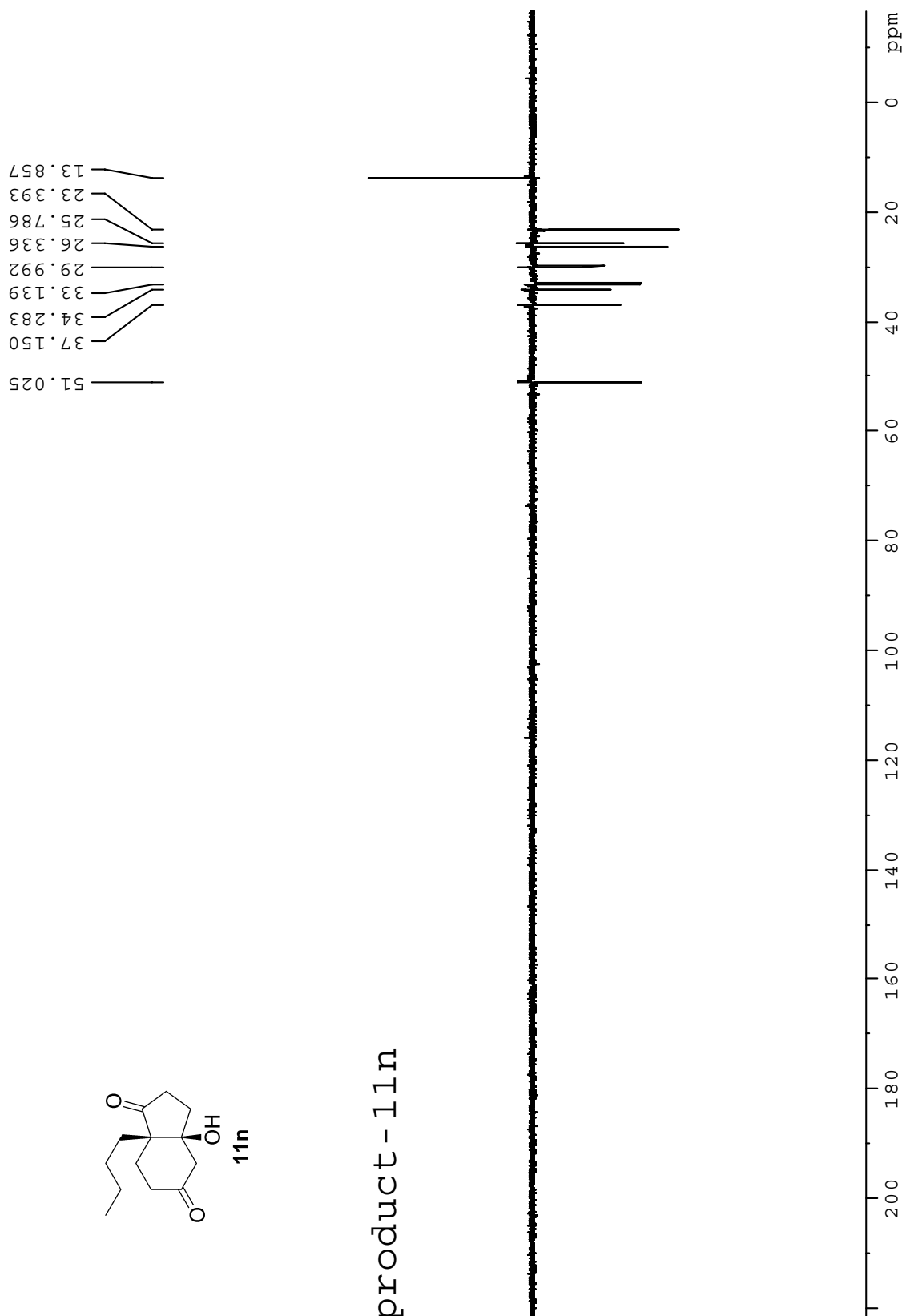

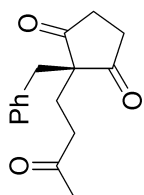

**12a**

product - 12a

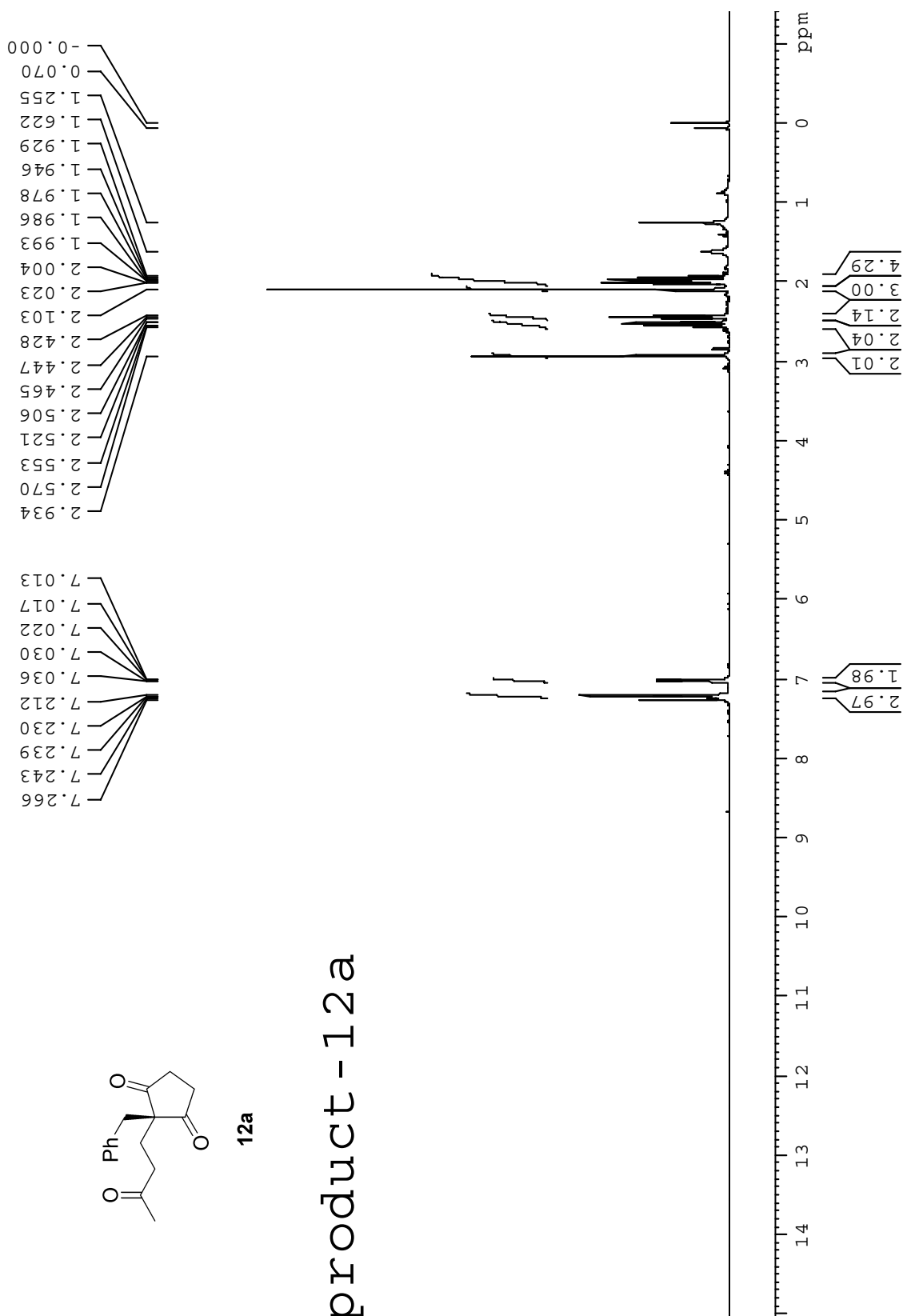

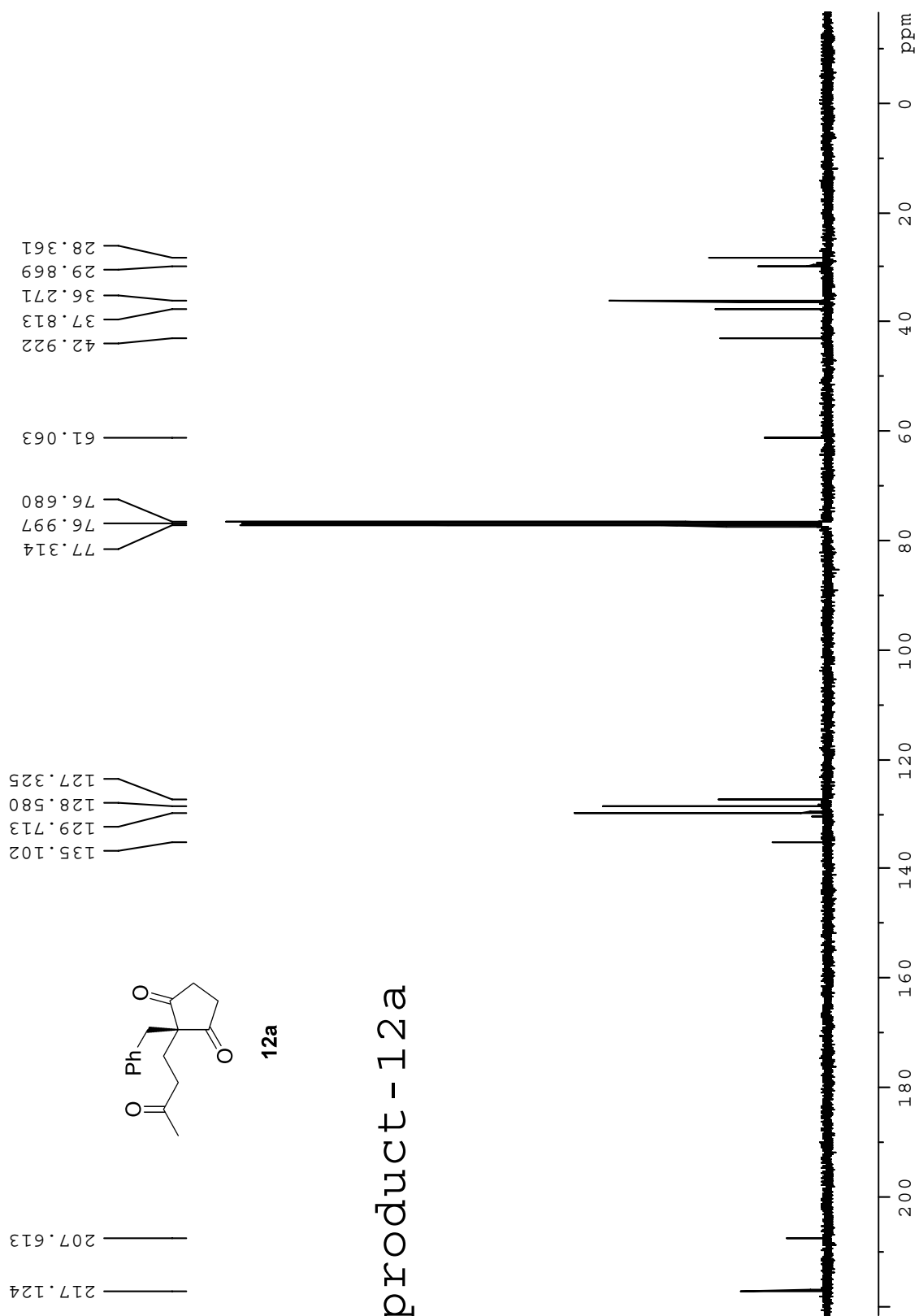

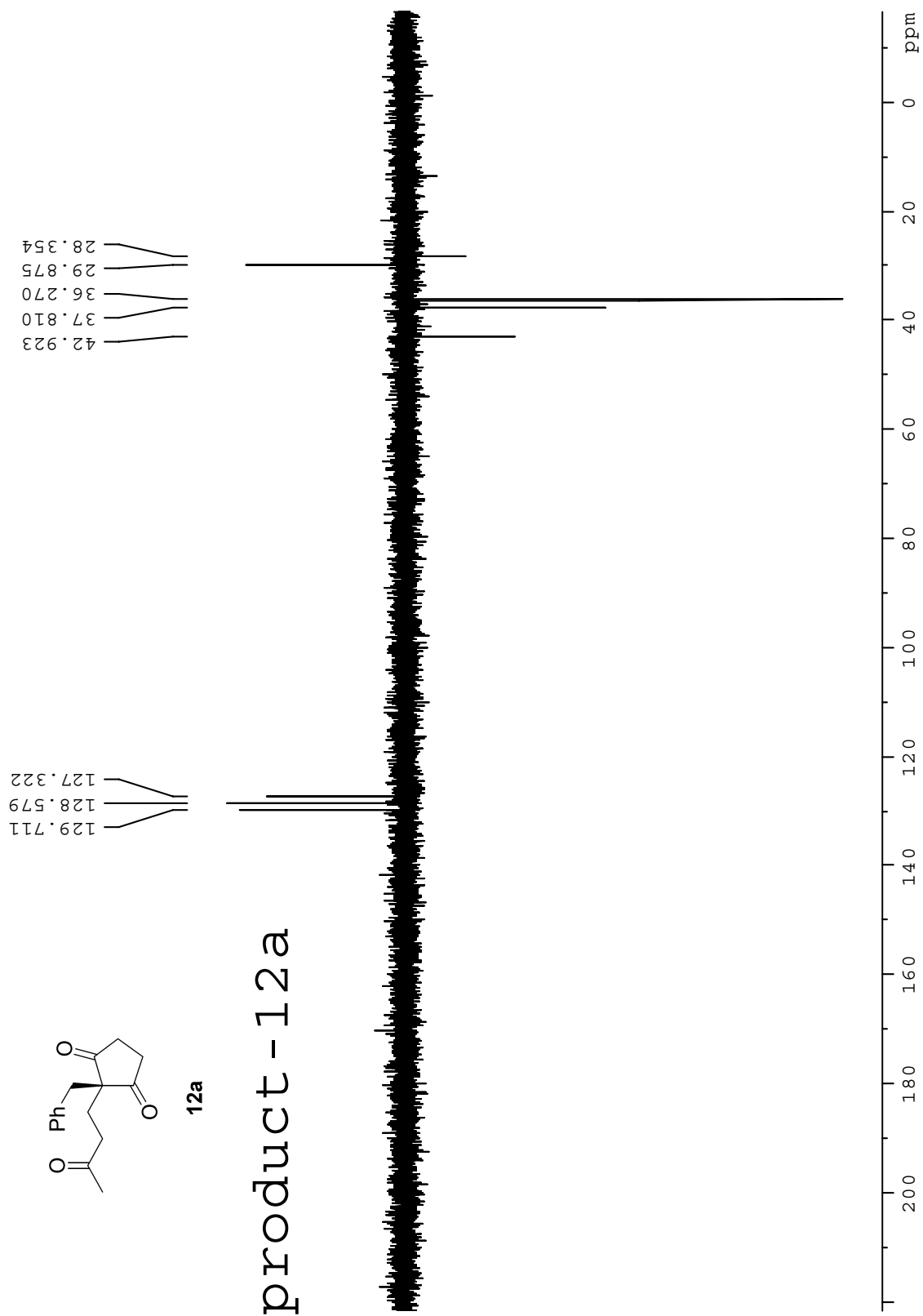

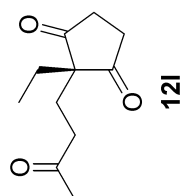

product - 121

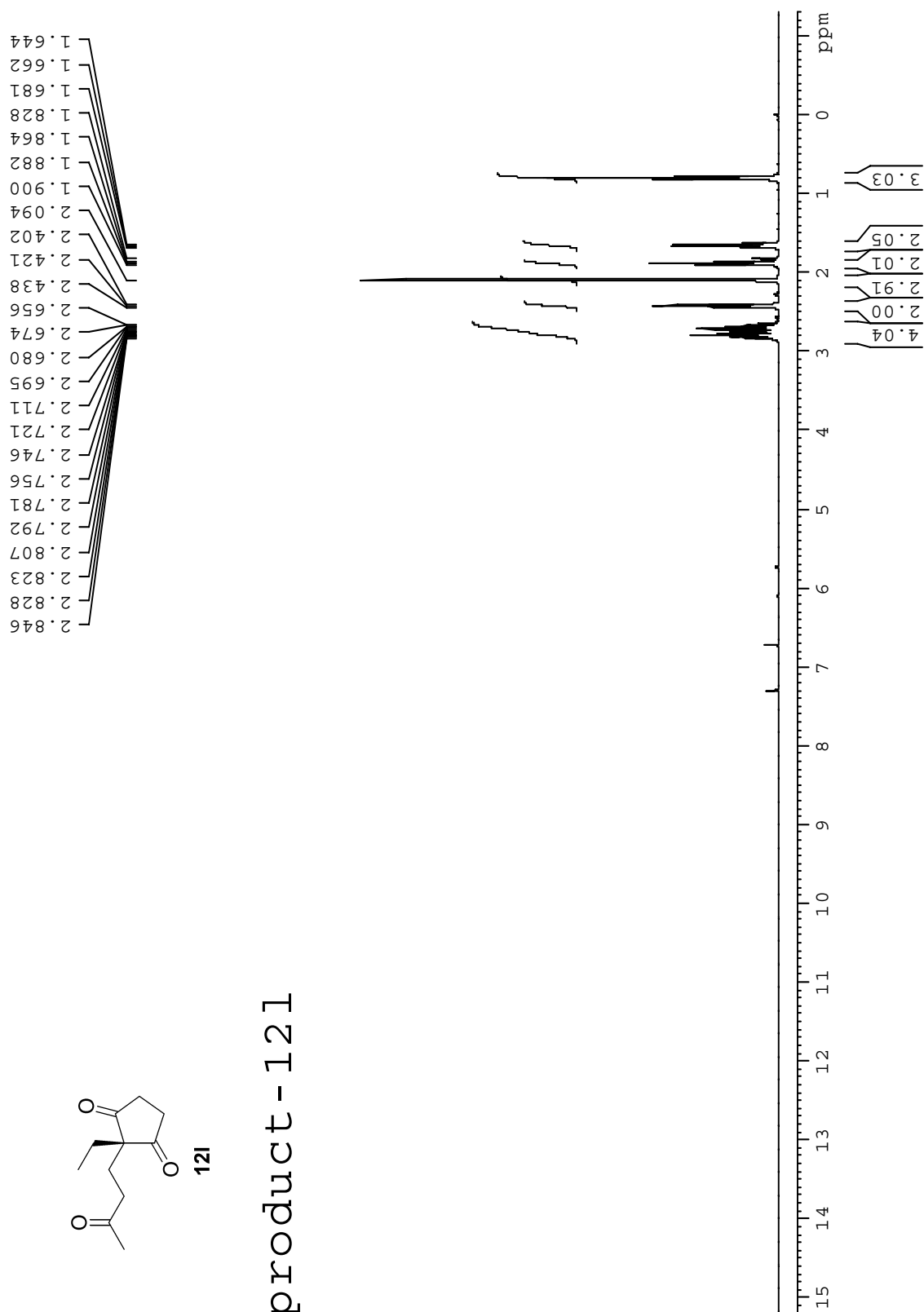

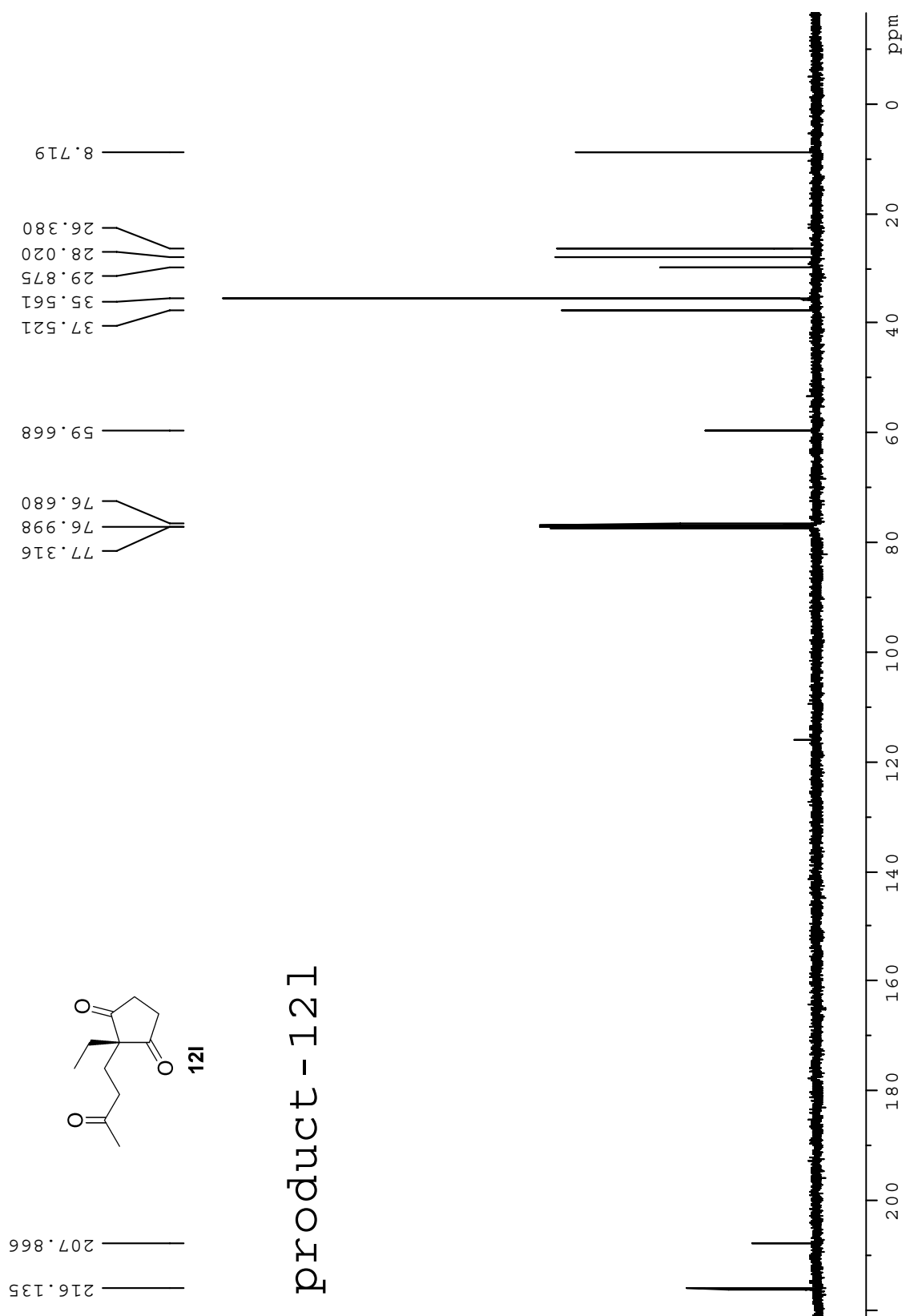

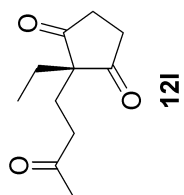

37.510  
35.552  
29.872  
28.018  
26.368  
8.720

product - 121

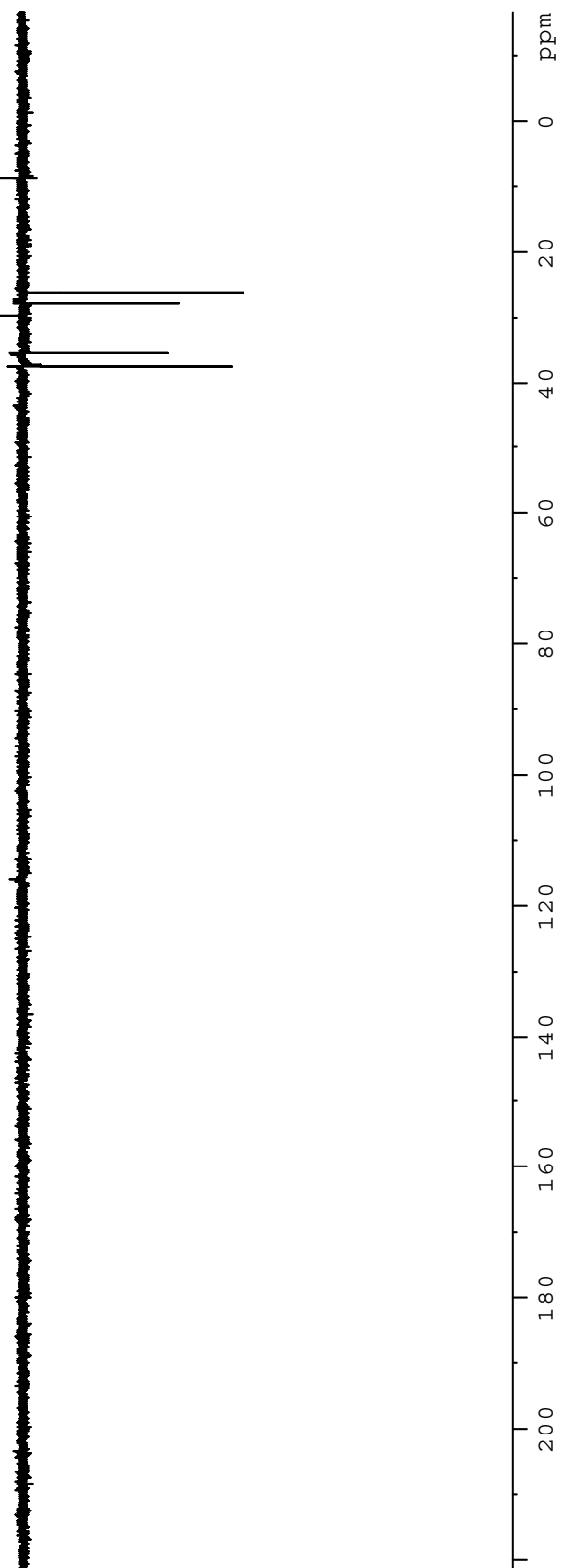

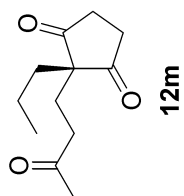

product - 12m

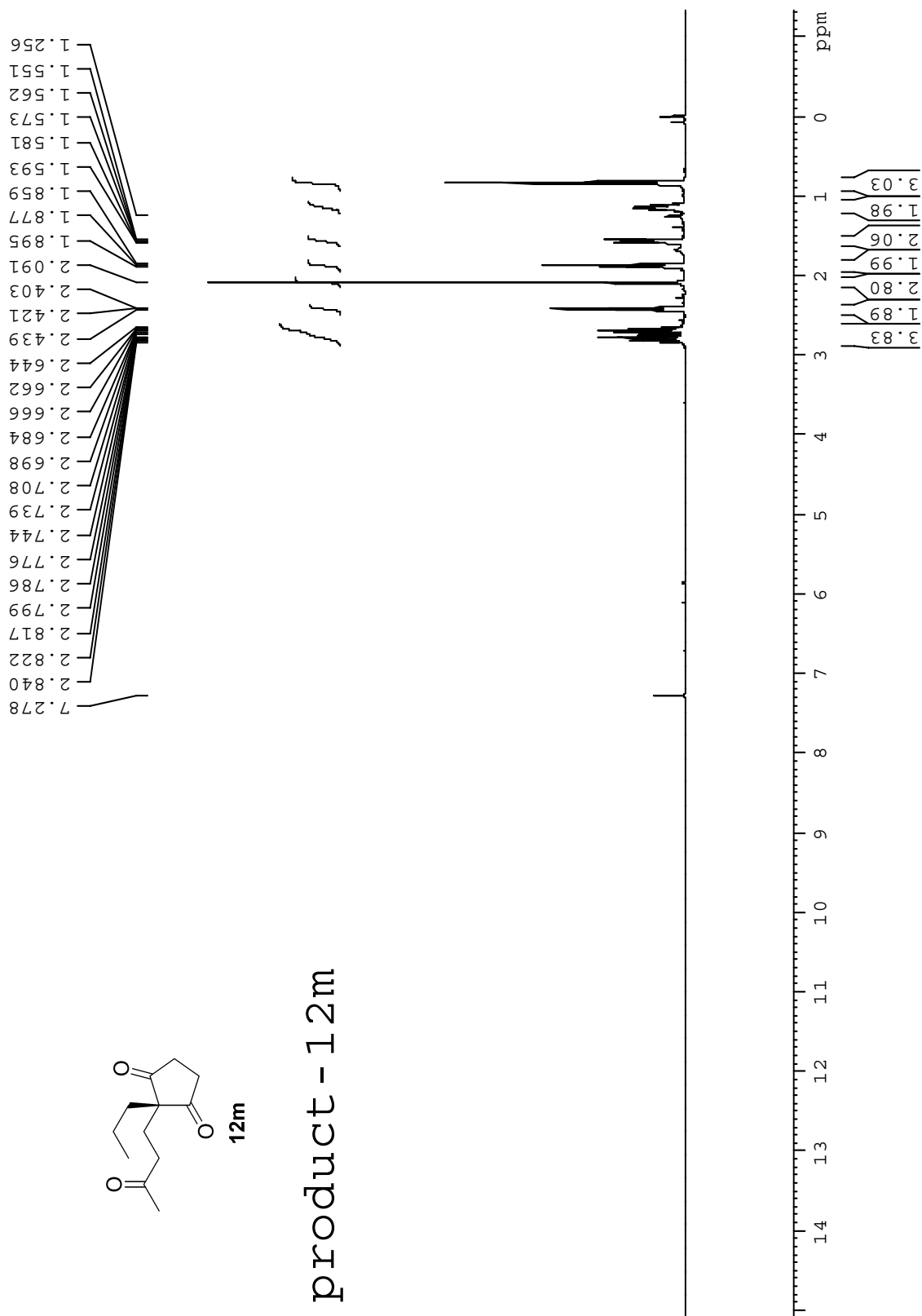



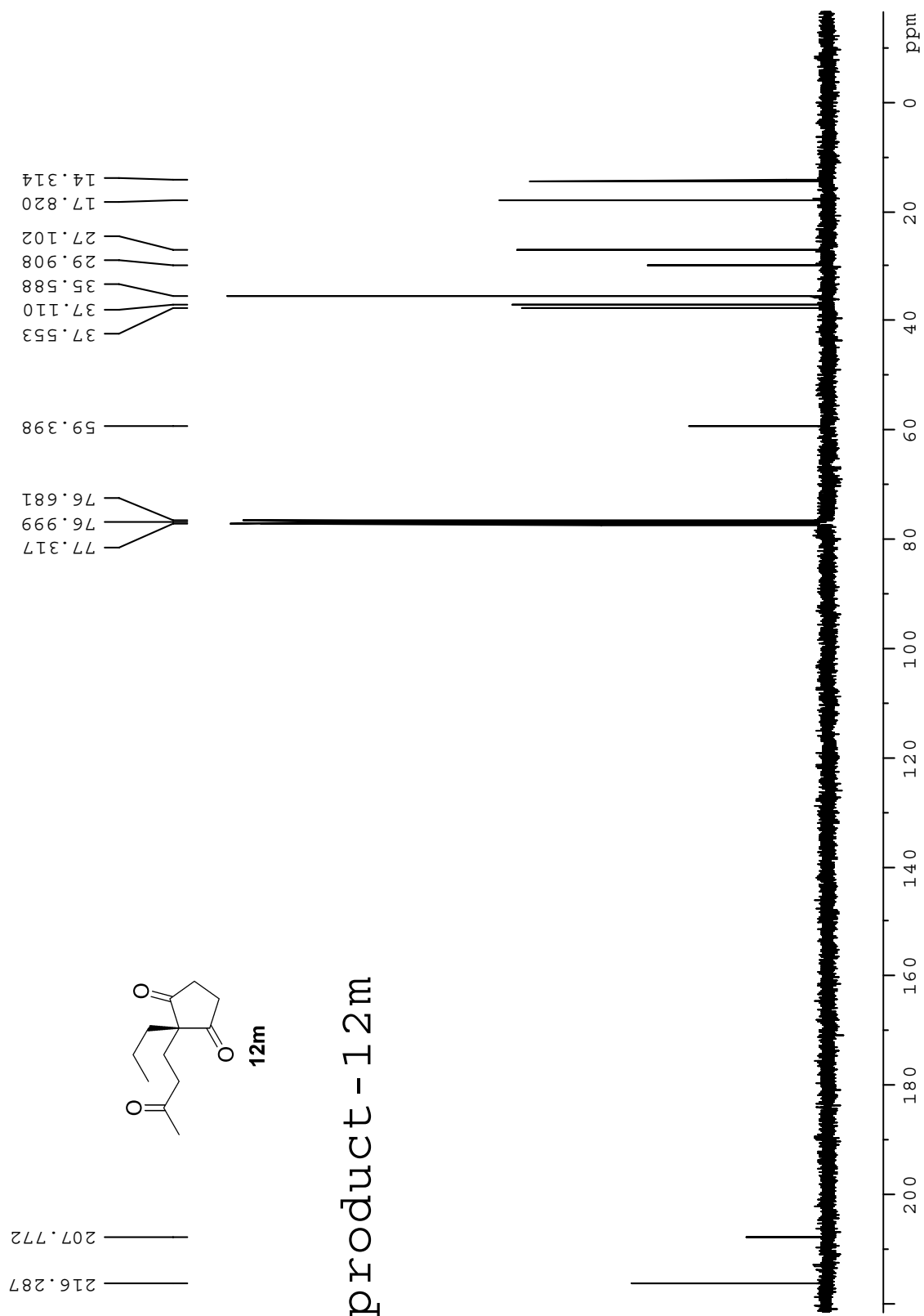

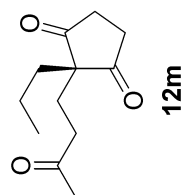

product - 12m

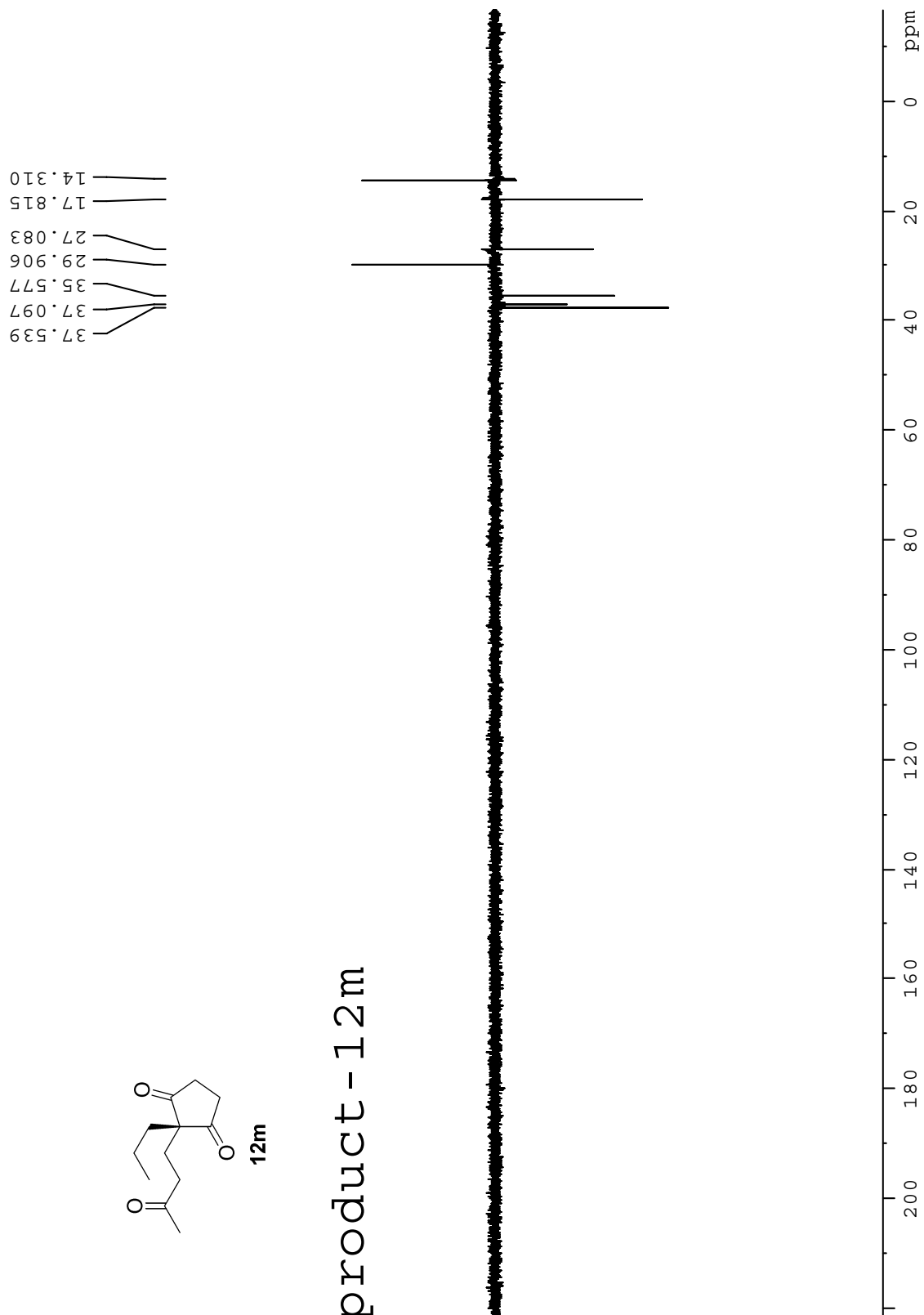

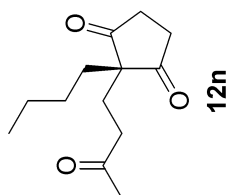

product - 12n

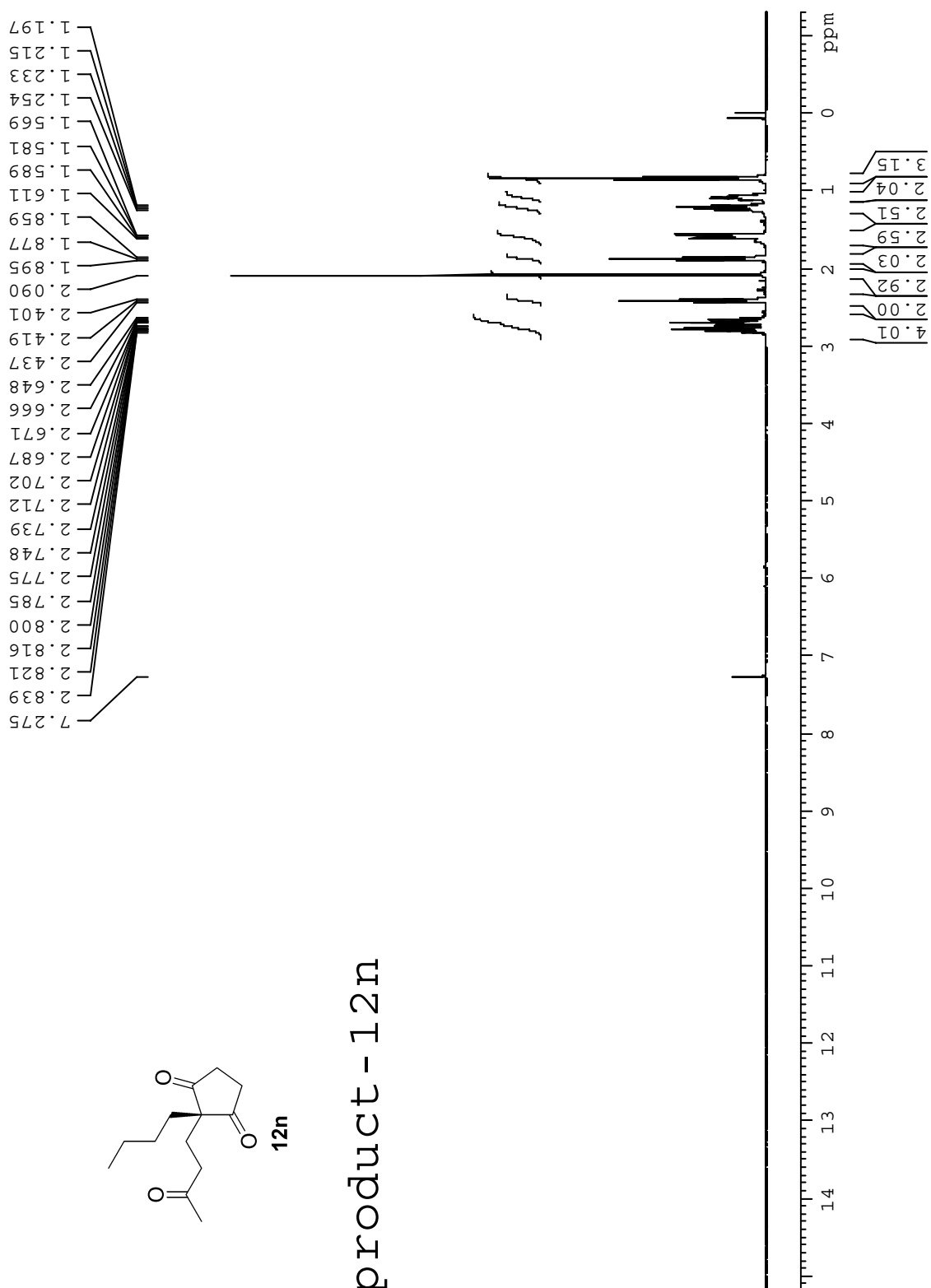

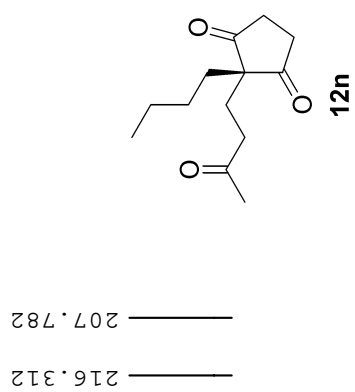

### product - 12n

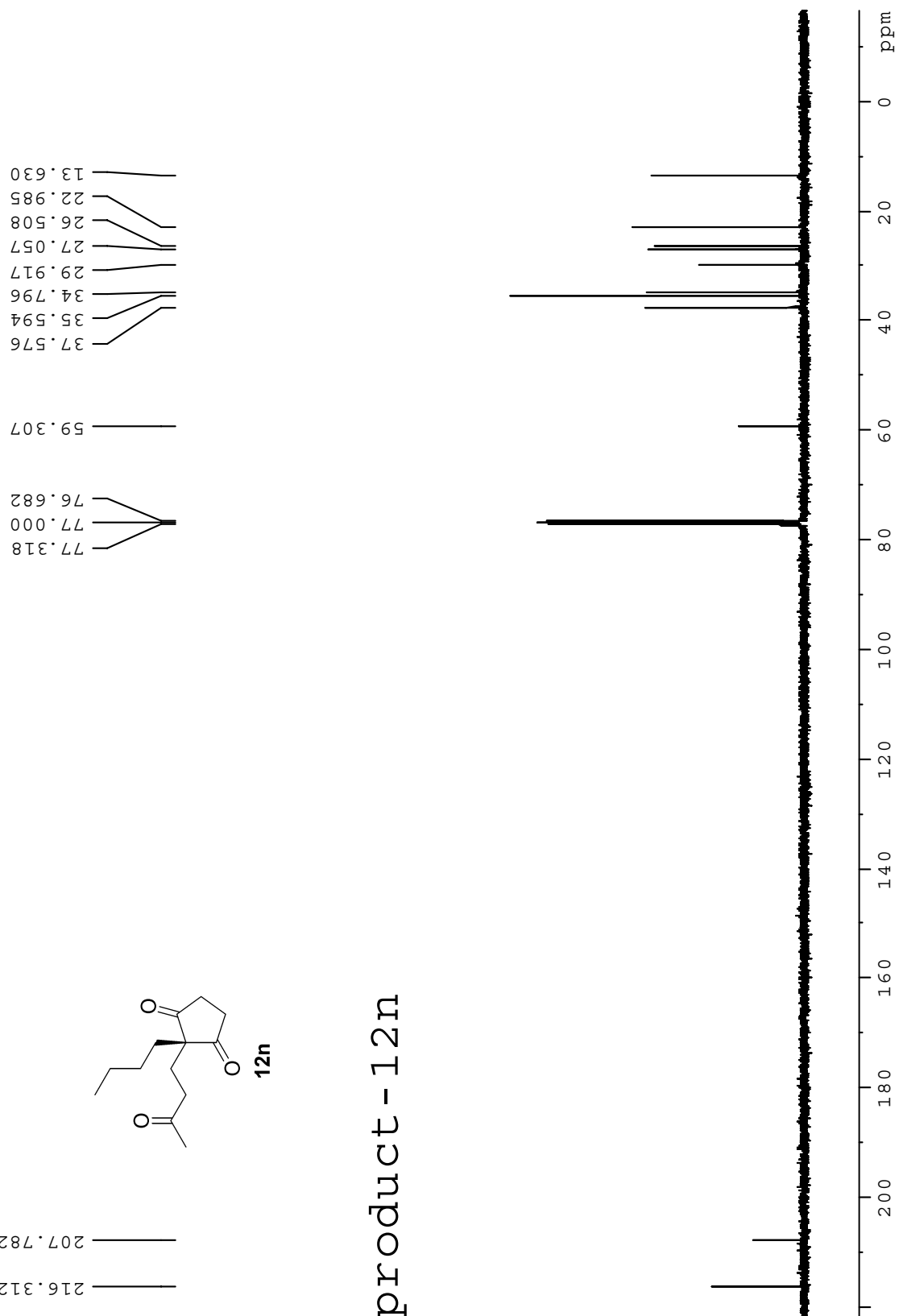

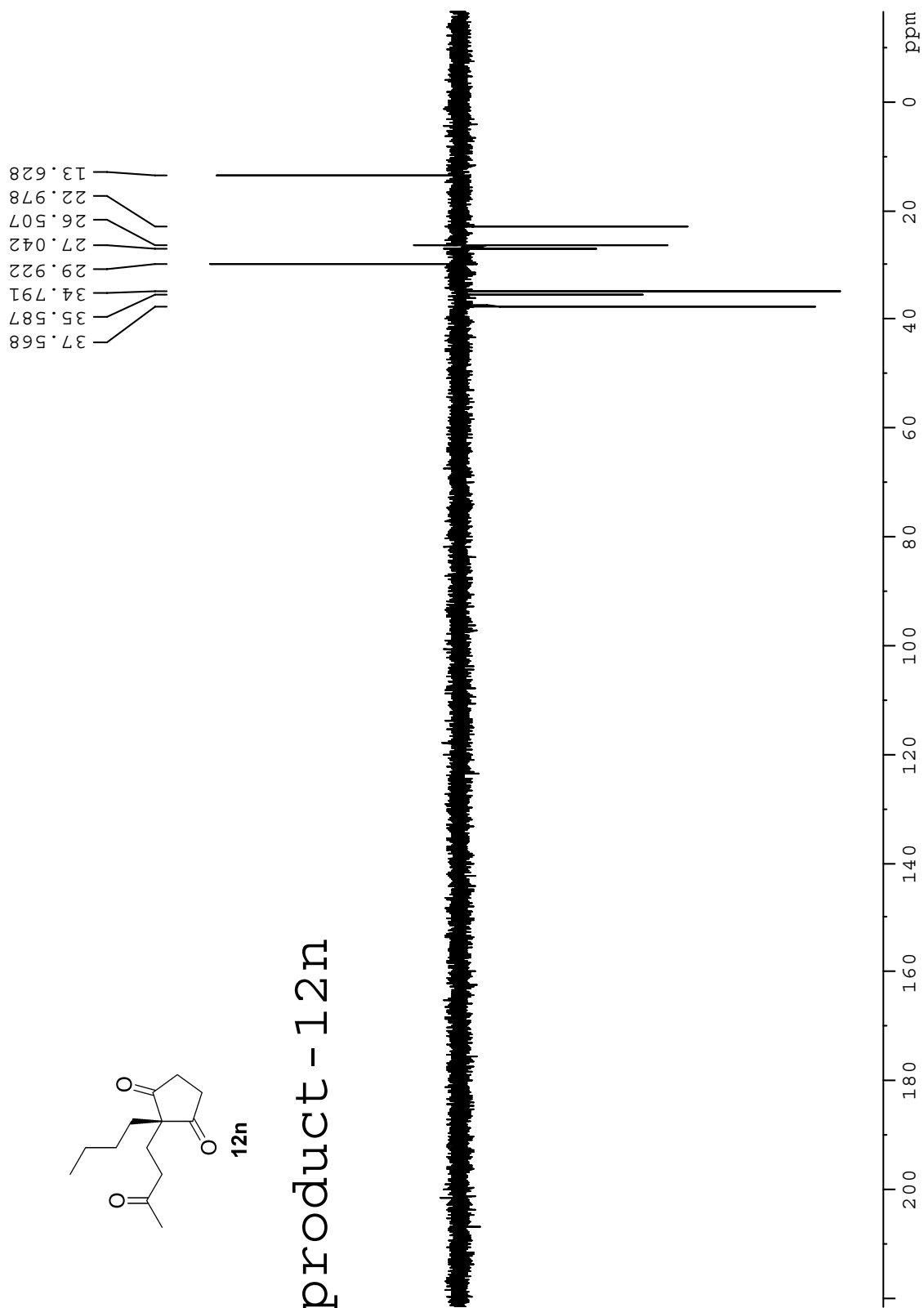

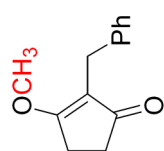

13a

# product - 13a

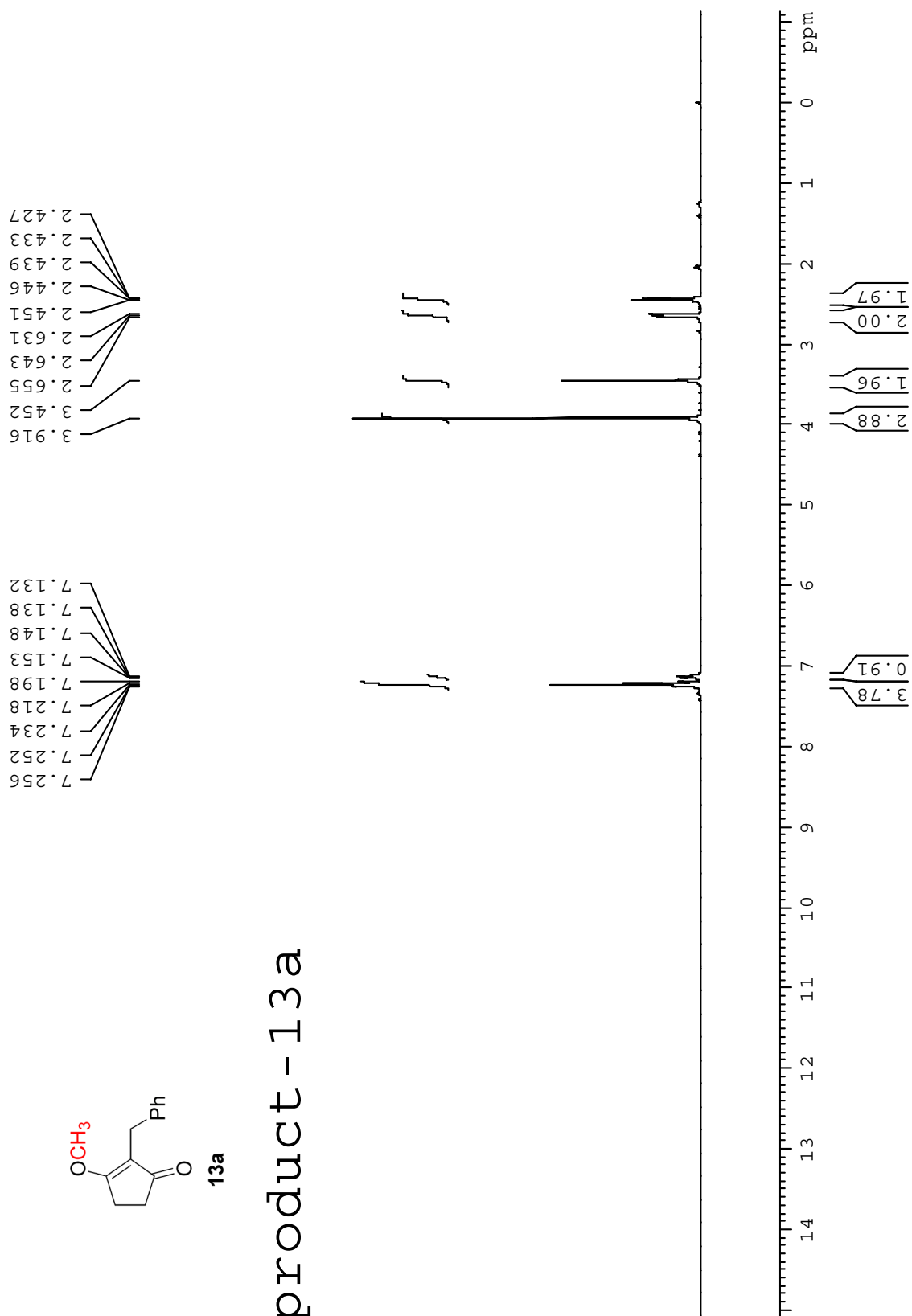

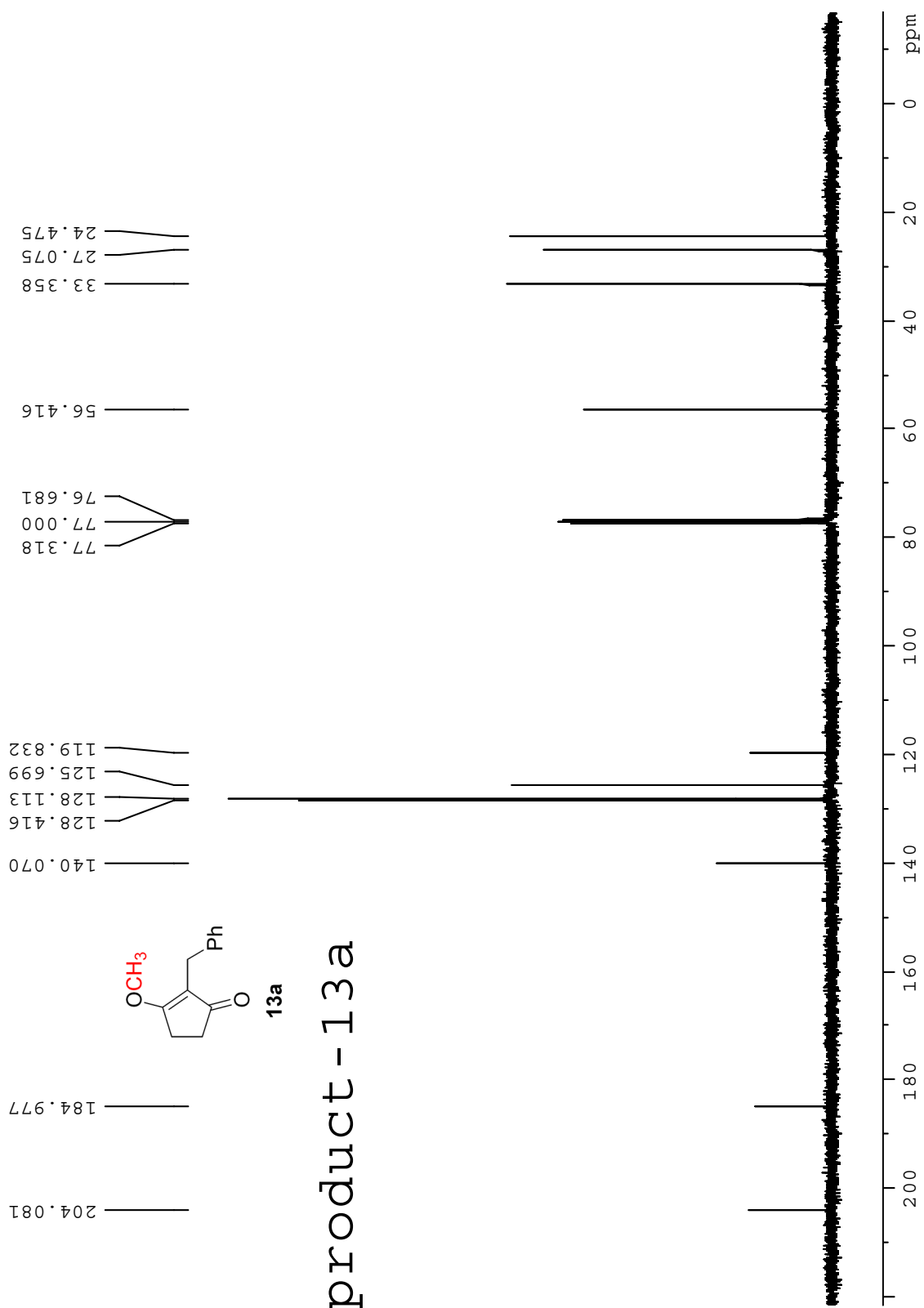

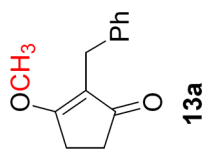

product - 13a

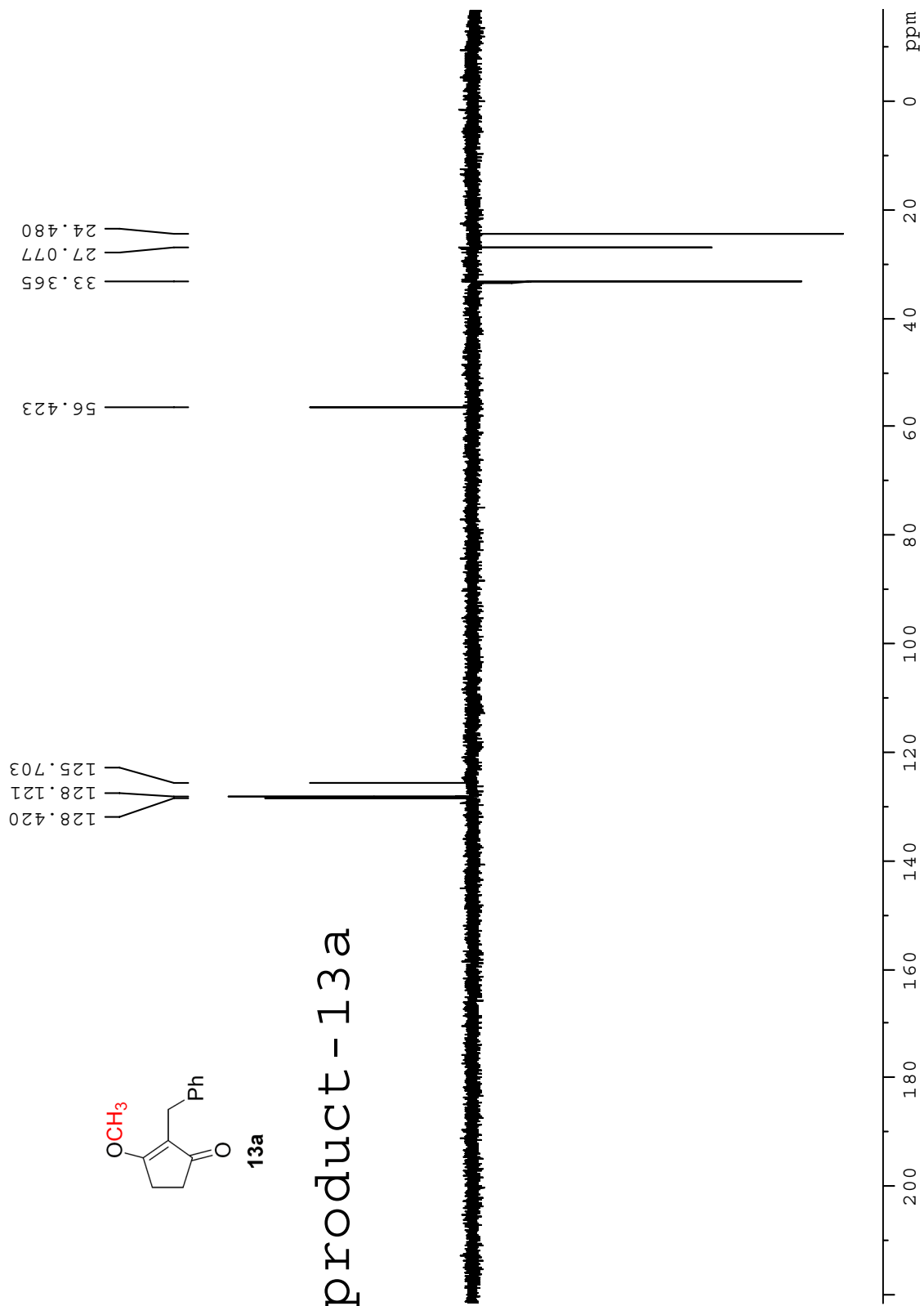



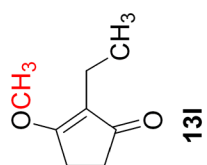

product - 131

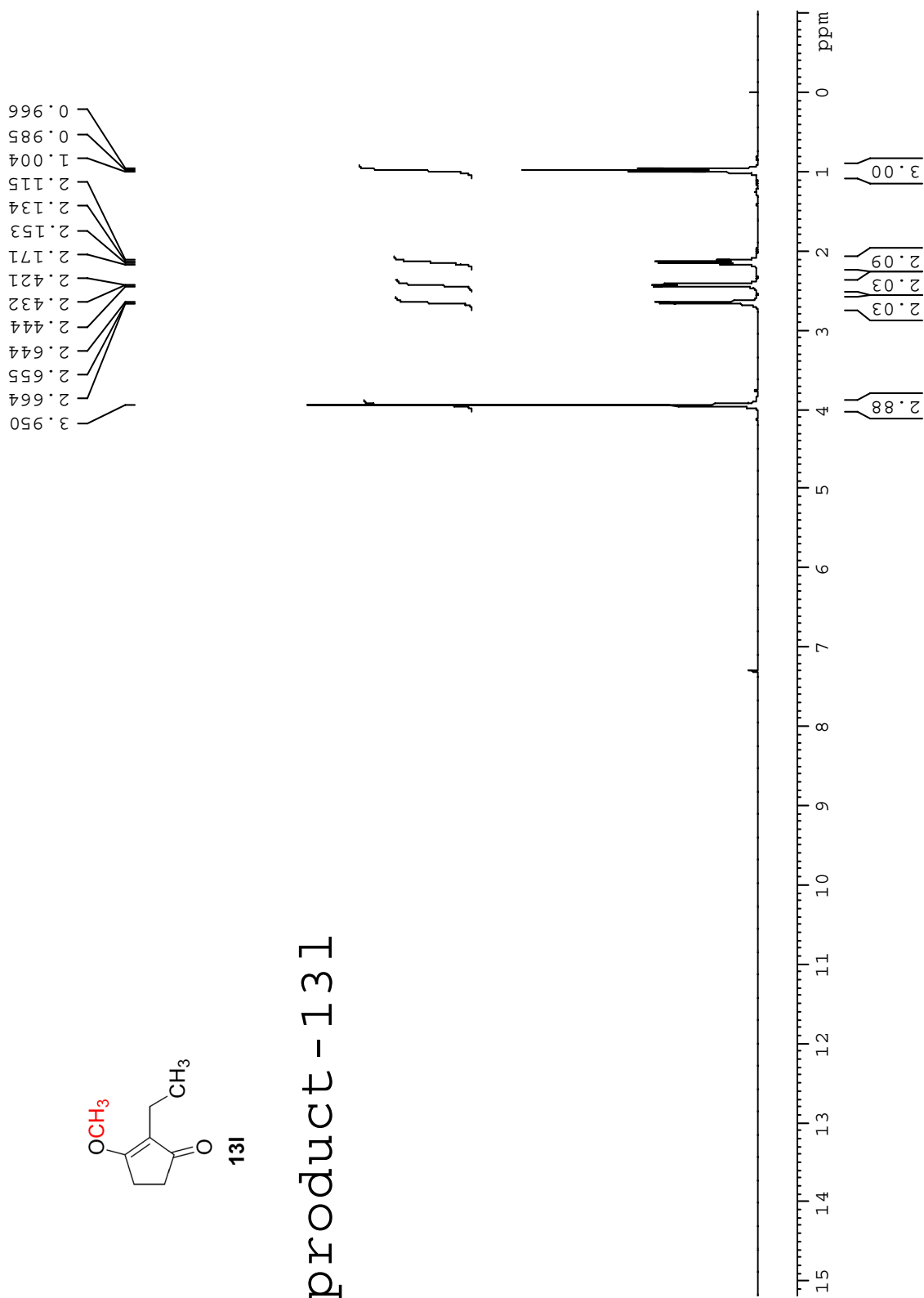

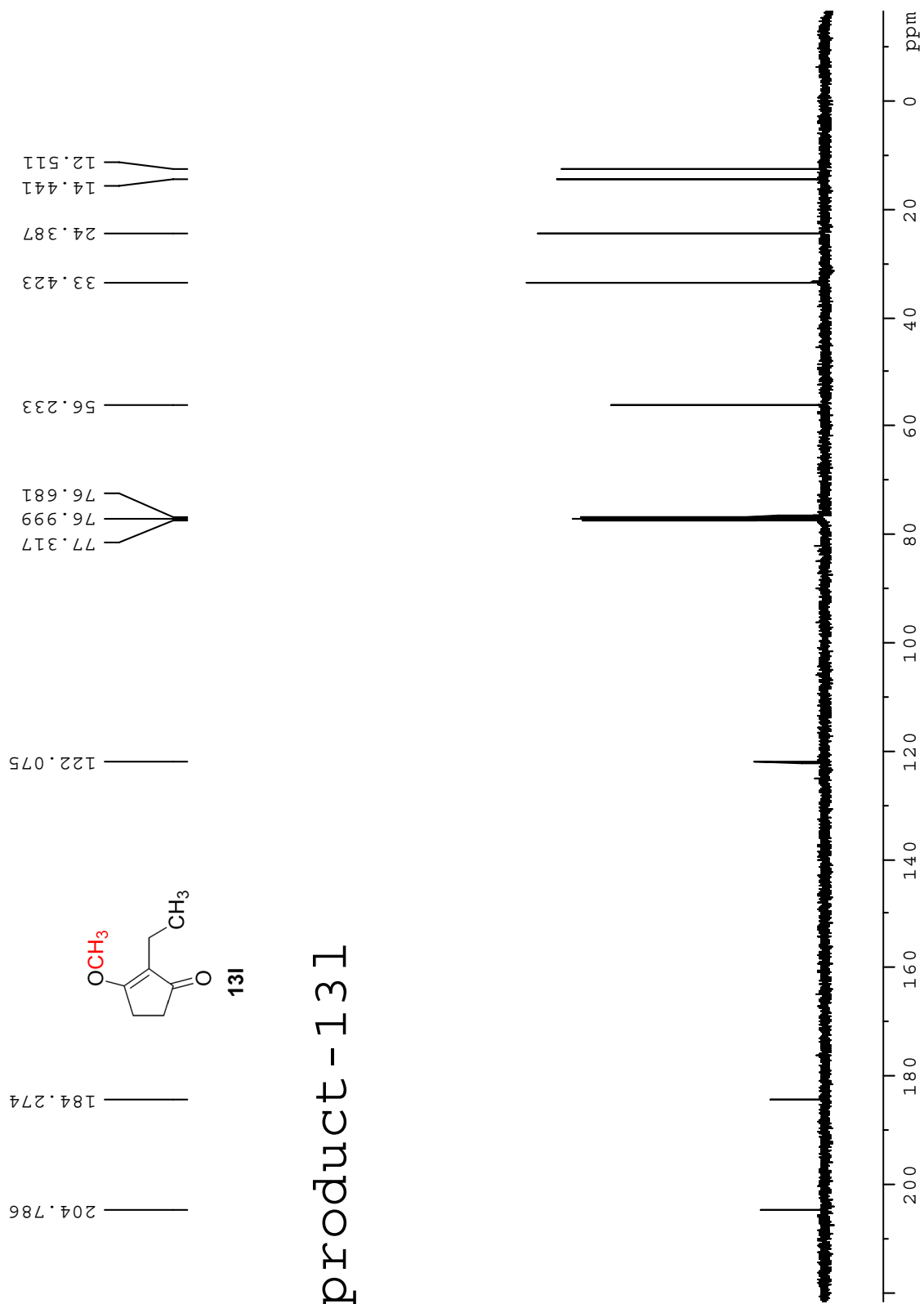

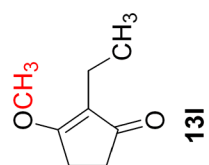

product - 13I

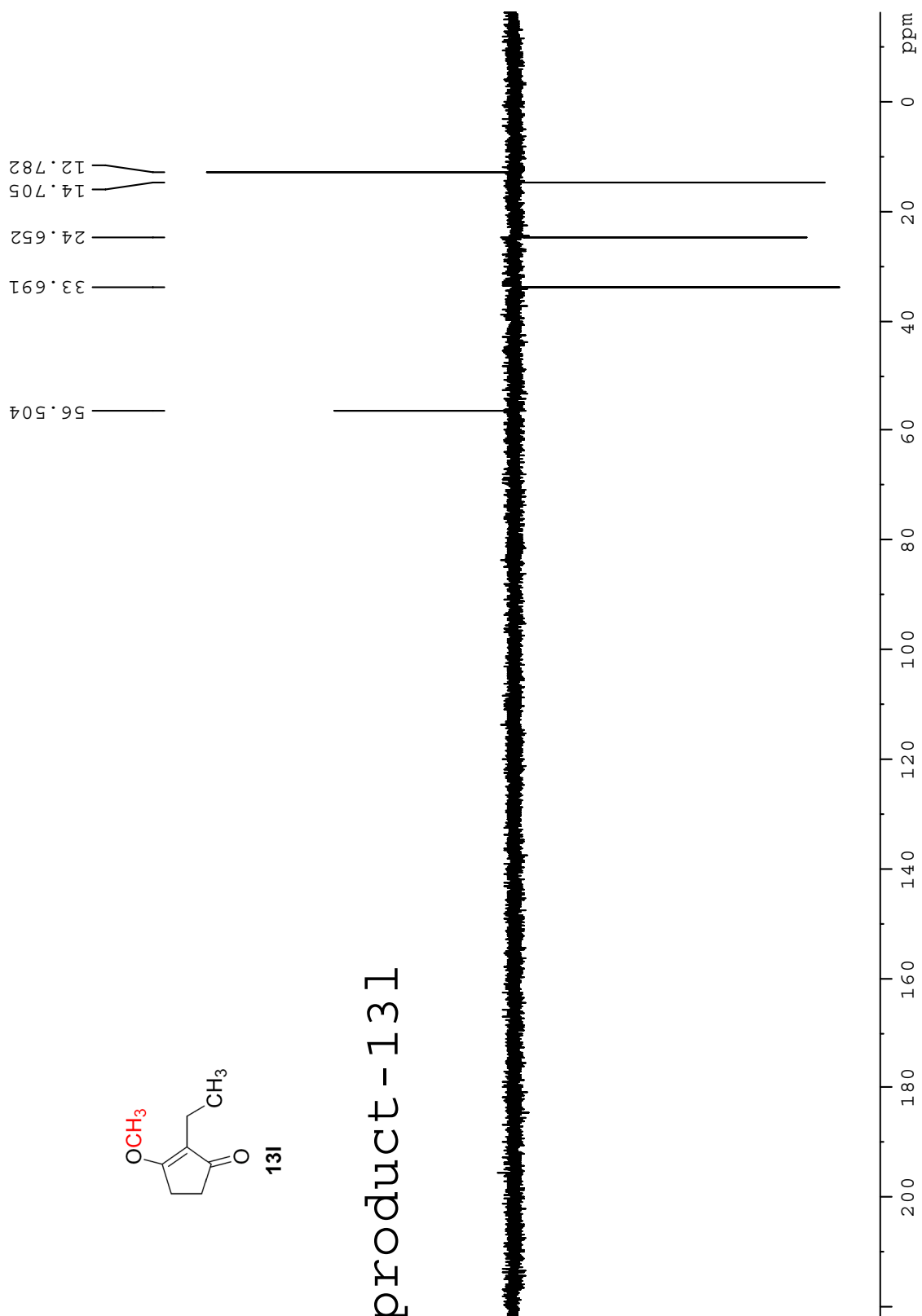

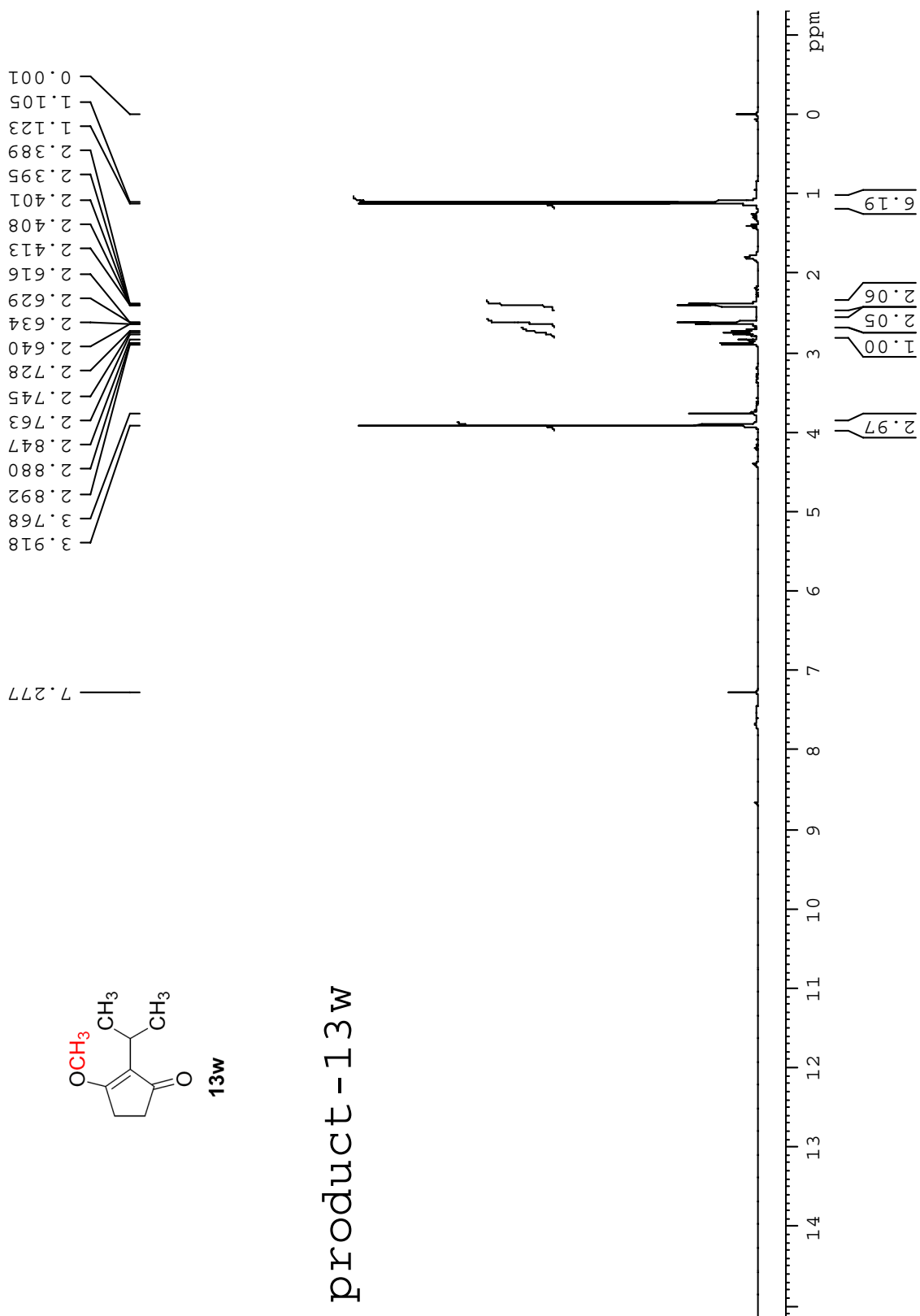

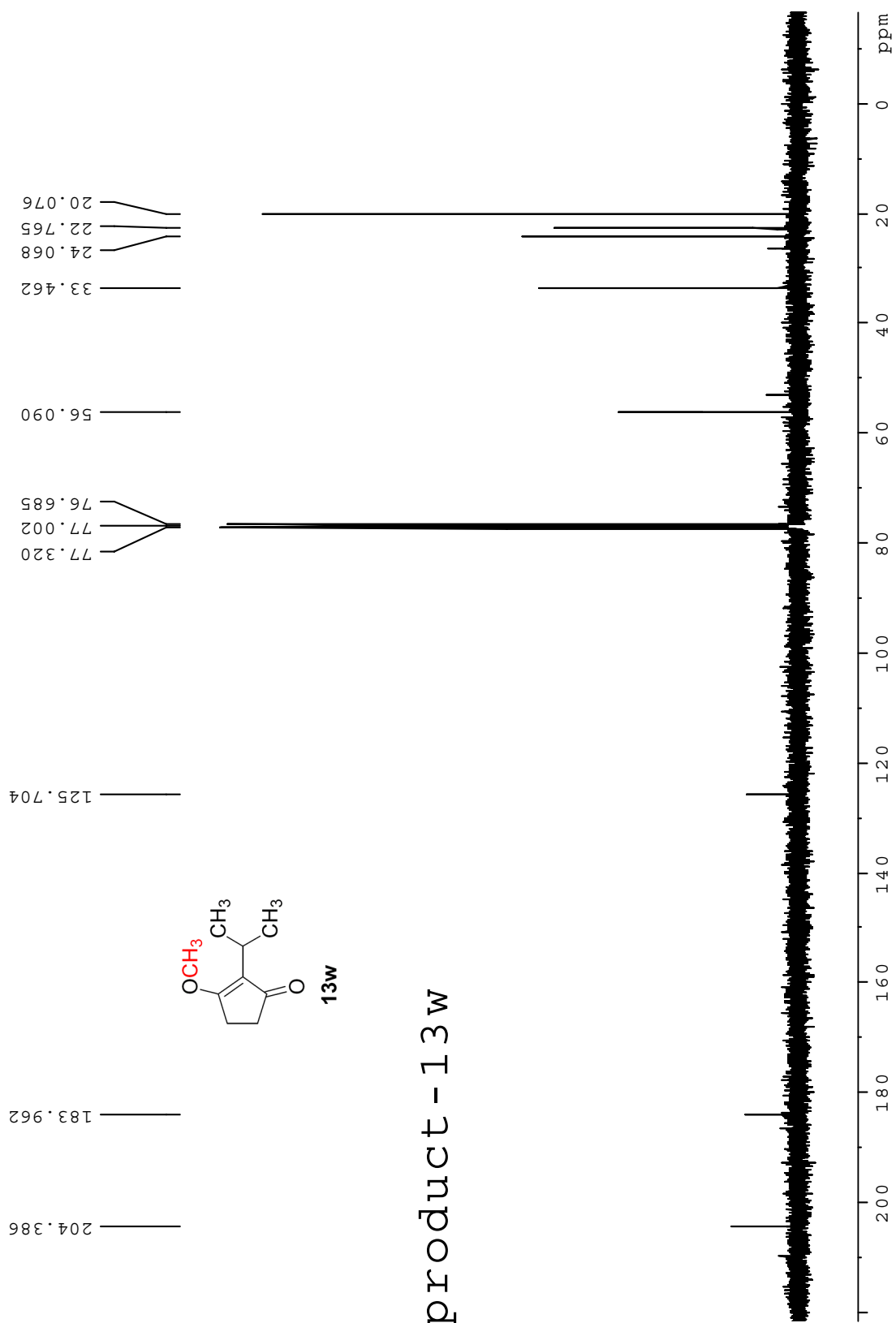

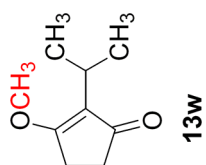

product-13w

