

**Supporting Information for:**

**Stereoselective Synthesis of Polyhydroxylated Aminocyclohexanes**

Sajjad Ahmad, Lynne H. Thomas and Andrew Sutherland\*

*WestCHEM, School of Chemistry, The Joseph Black Building, University of Glasgow, Glasgow, UK  
G12 8QQ. Email: Andrew.Sutherland@glasgow.ac.uk*

**Table of Contents**

1. Key NOE Enhancements for <b>15</b> , <b>17</b> , <b>22</b> and <b>23</b> .	S2
2. <sup>1</sup> H NMR and <sup>13</sup> C NMR Spectra of Compounds.	S3–S18

### 1. Key NOE Enhancements for 15, 17, 22 and 23.

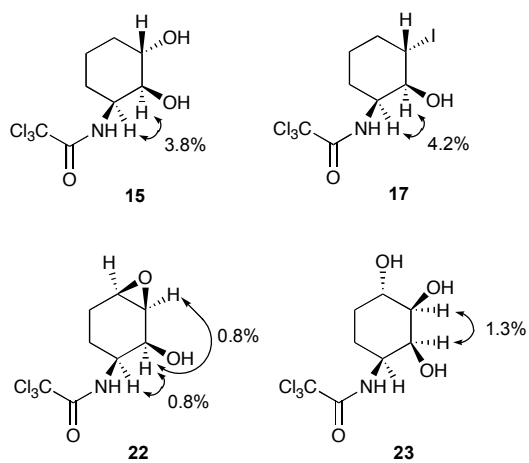

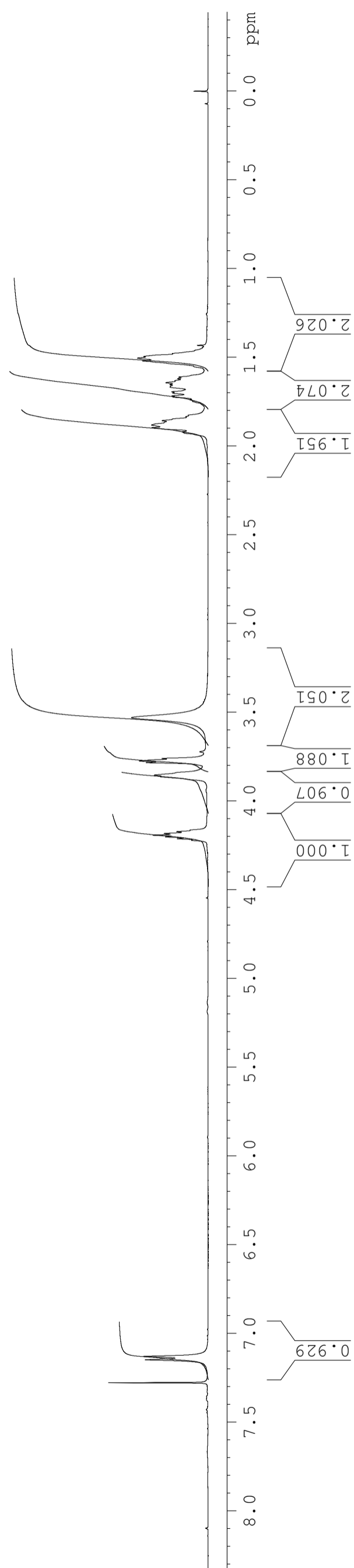
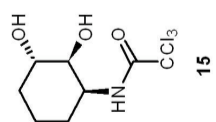

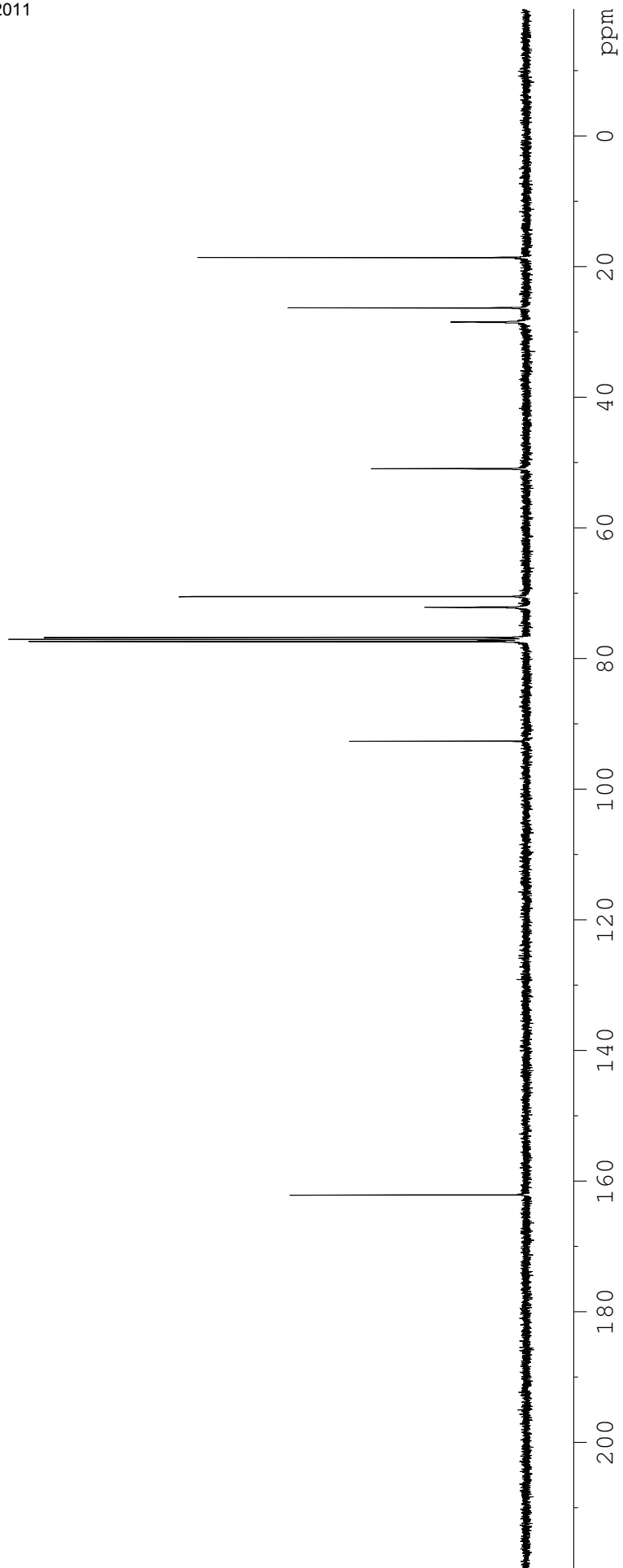
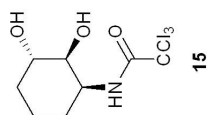

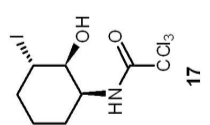

17

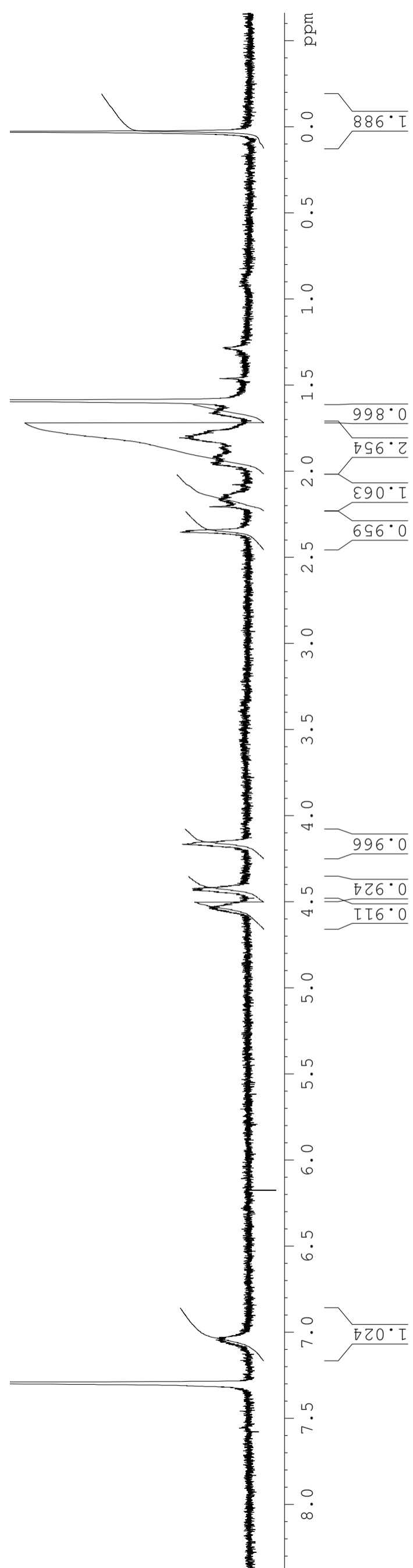

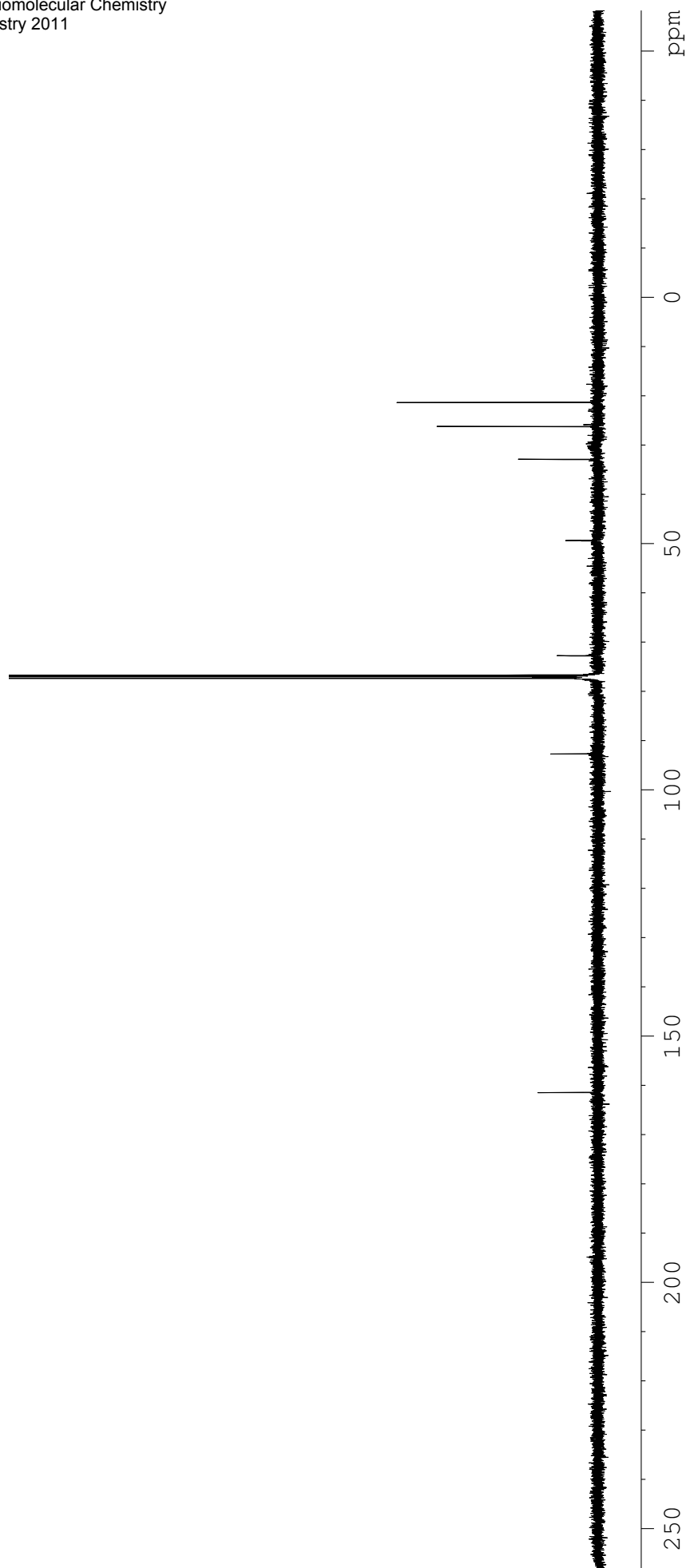
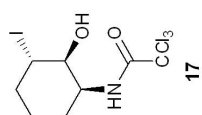

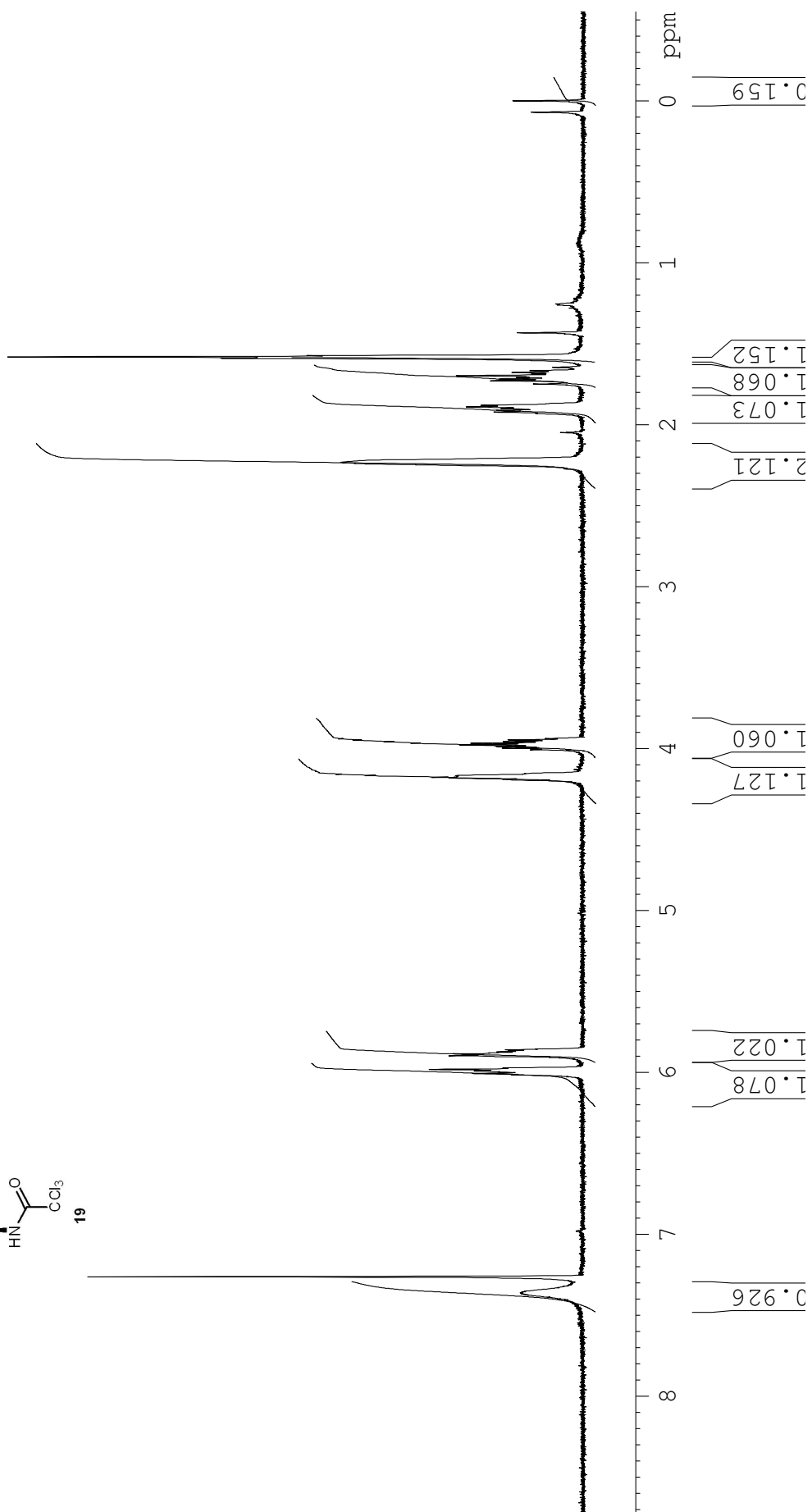
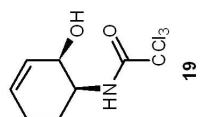

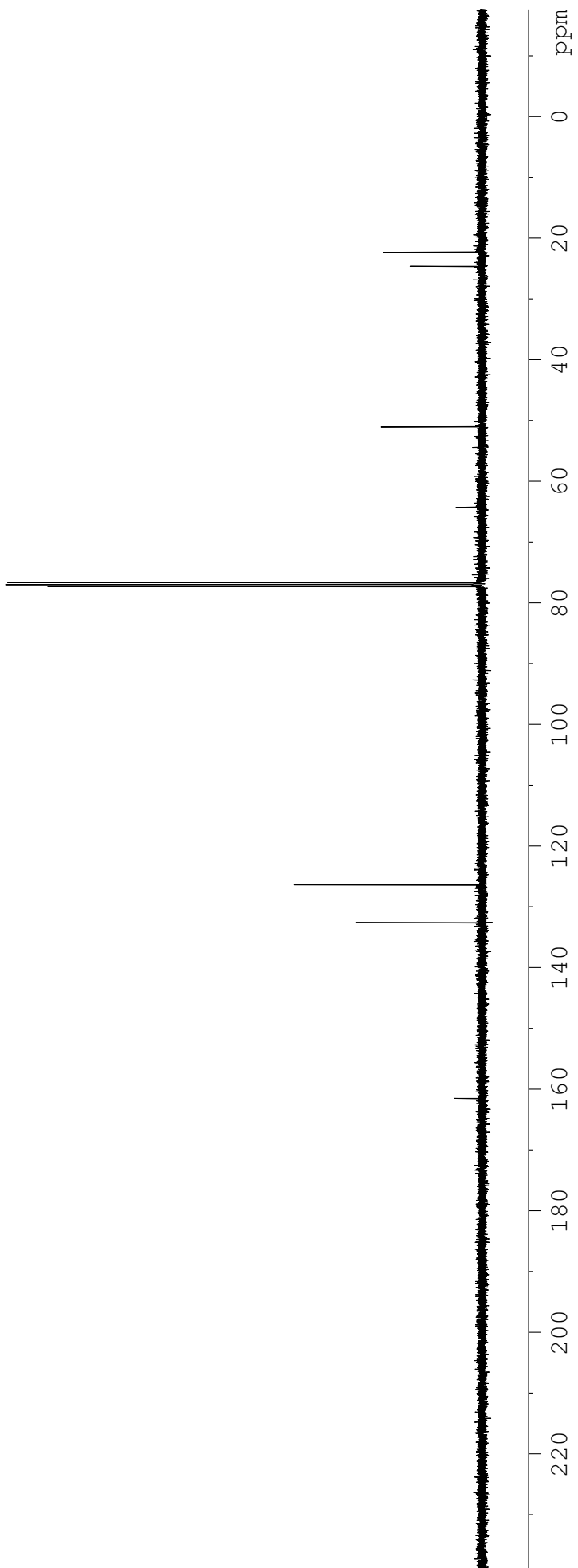
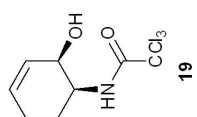



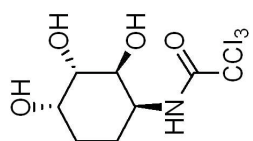

21

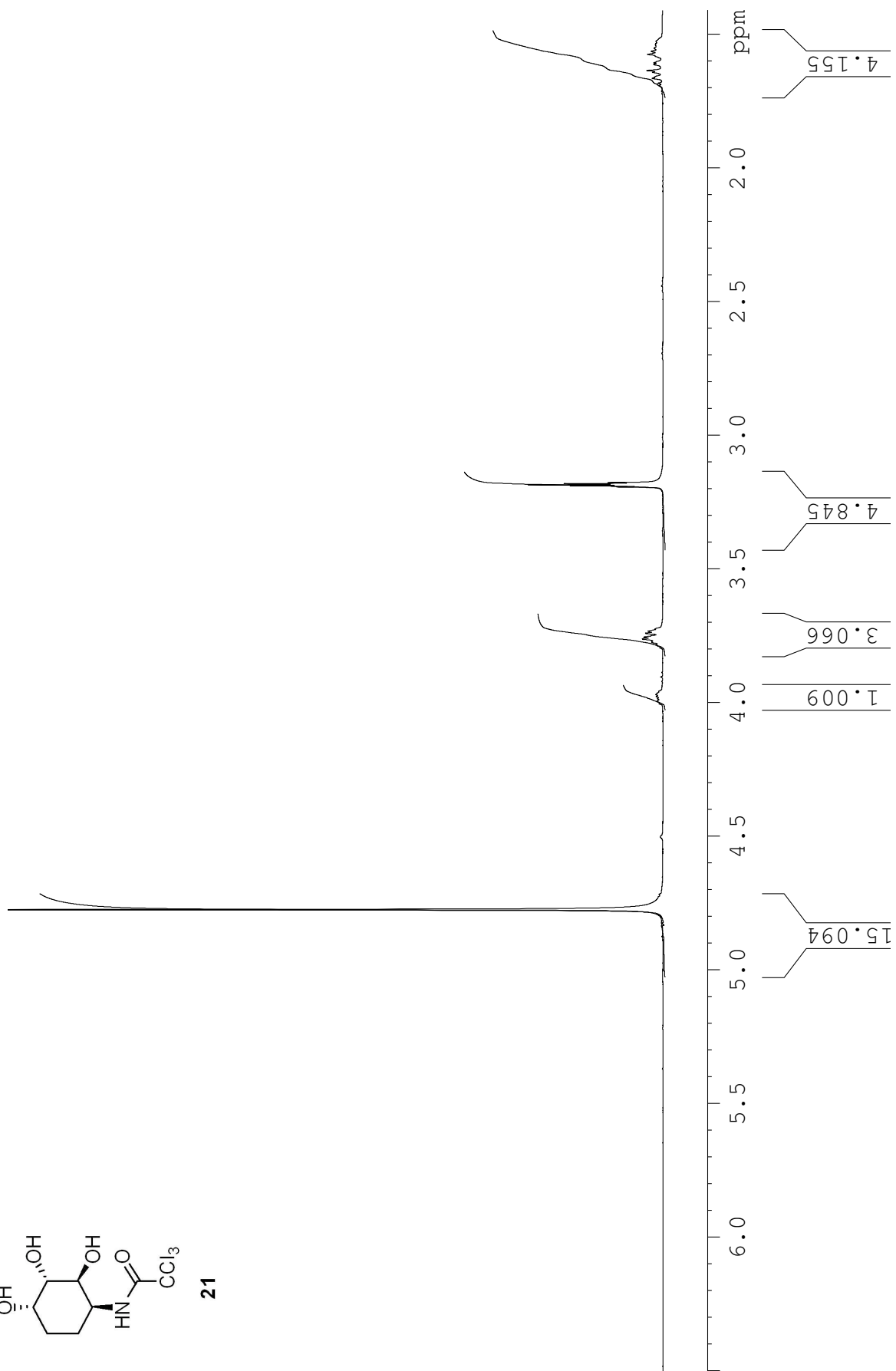

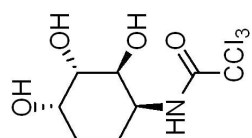

21

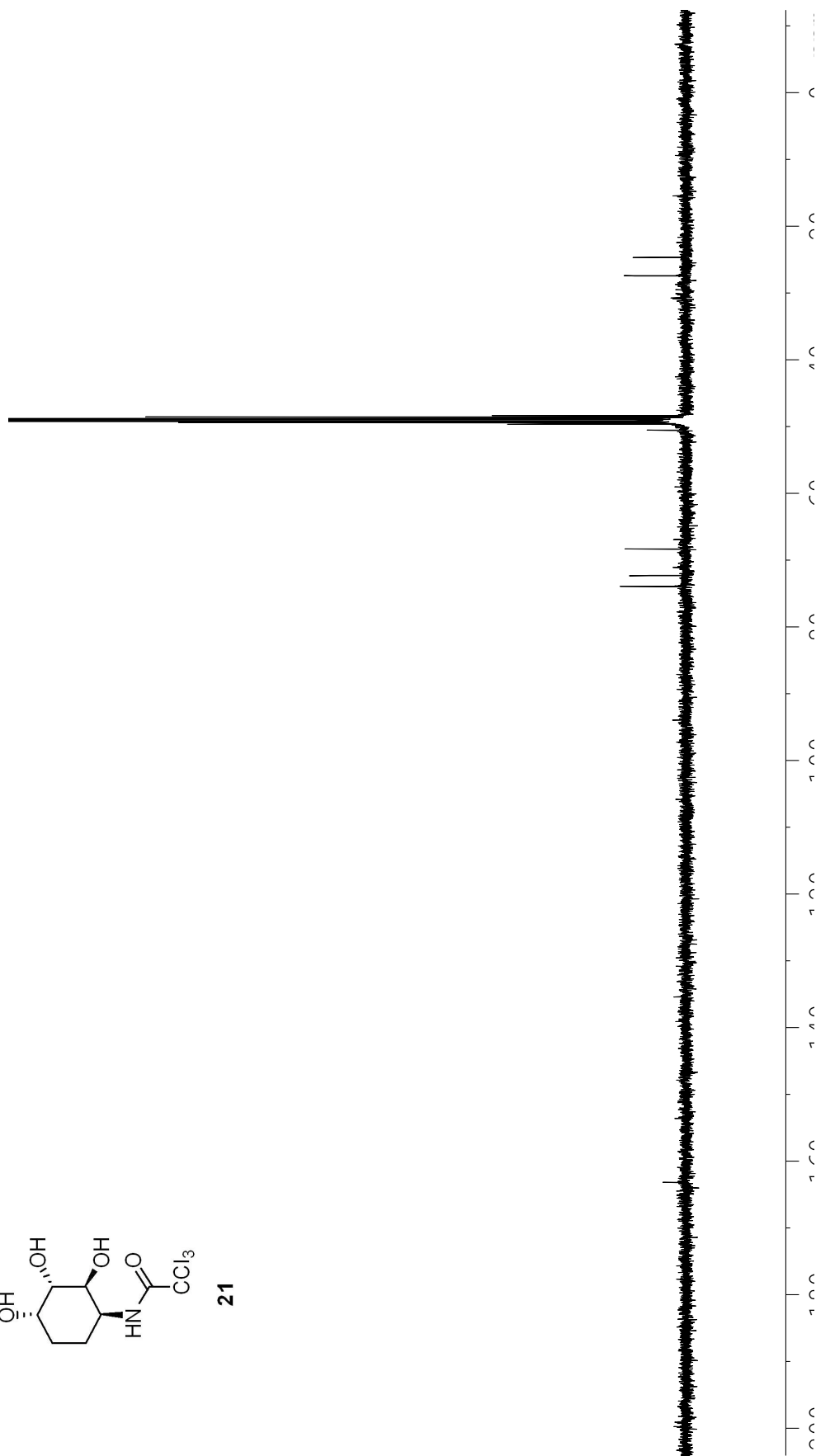

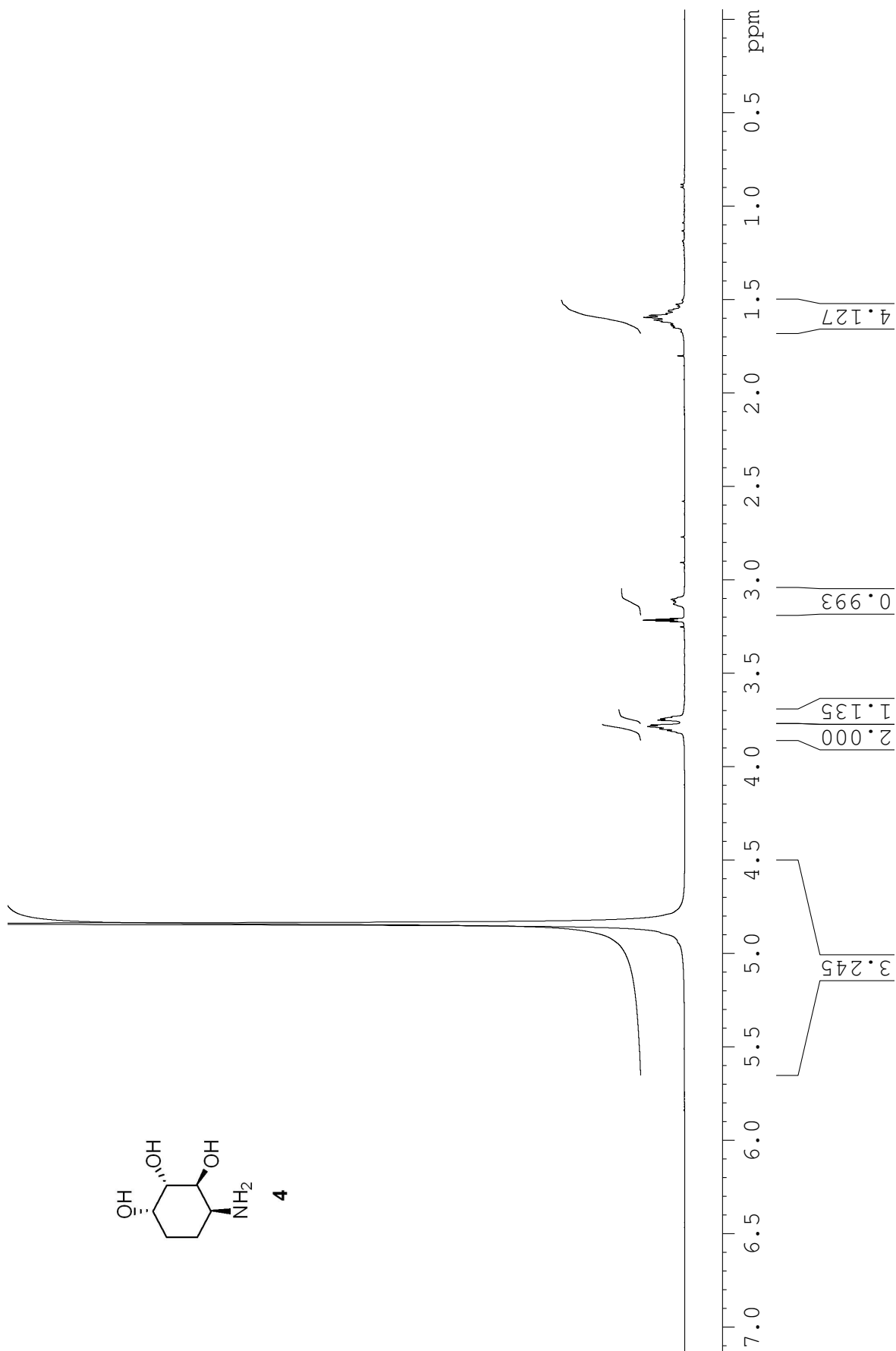

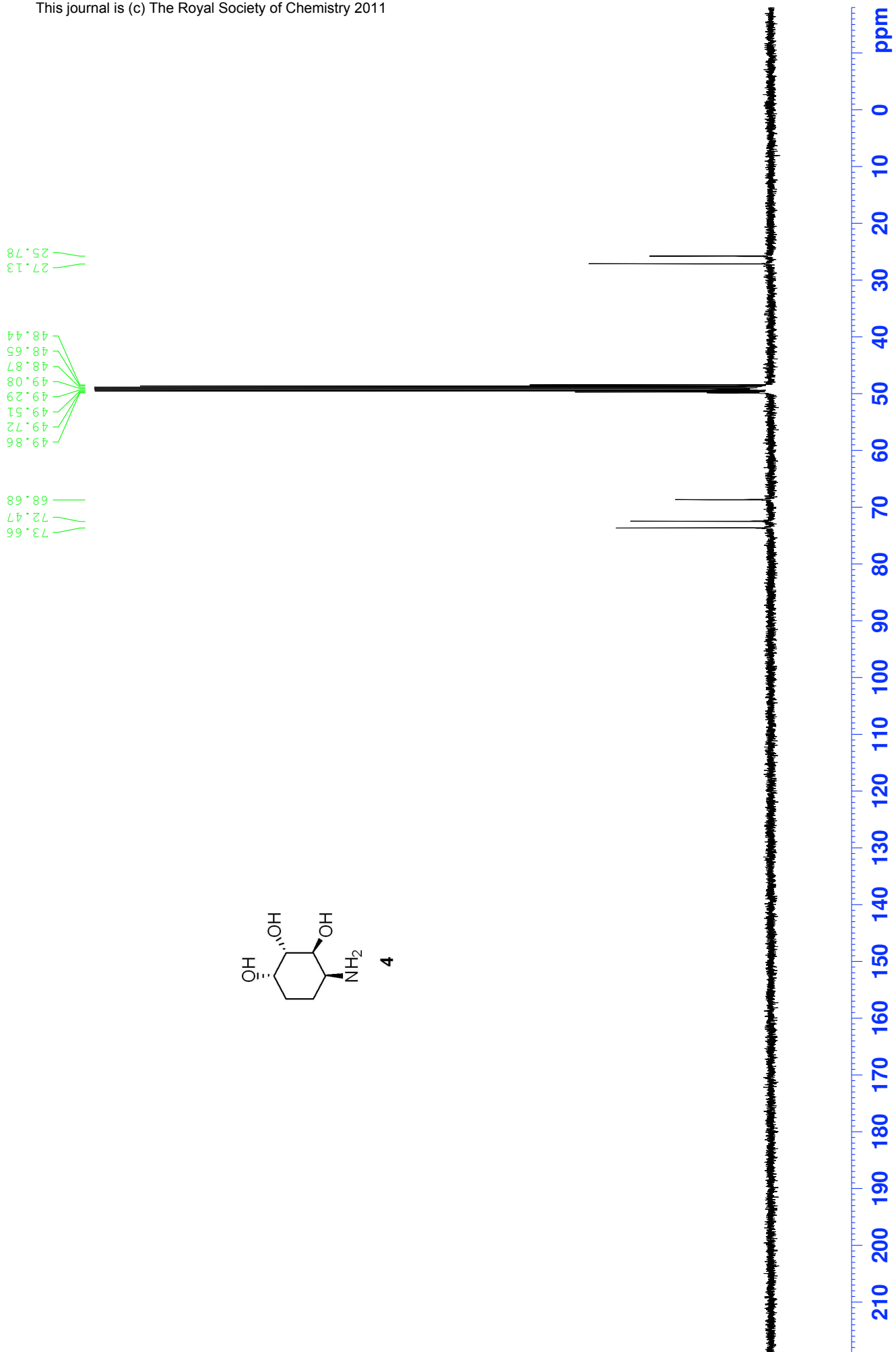
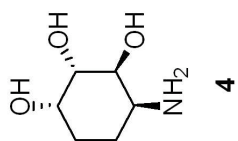

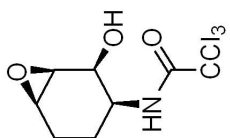
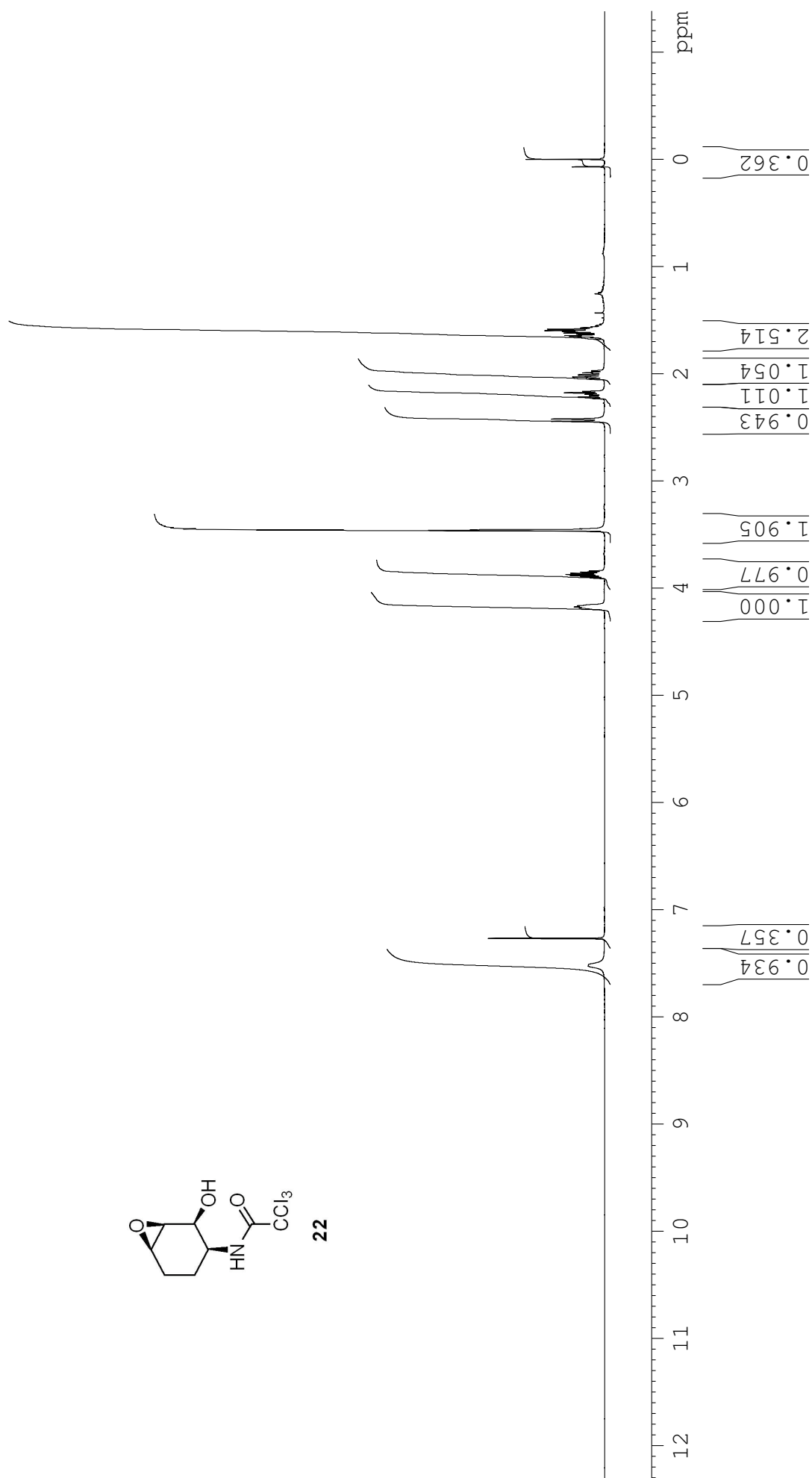

22

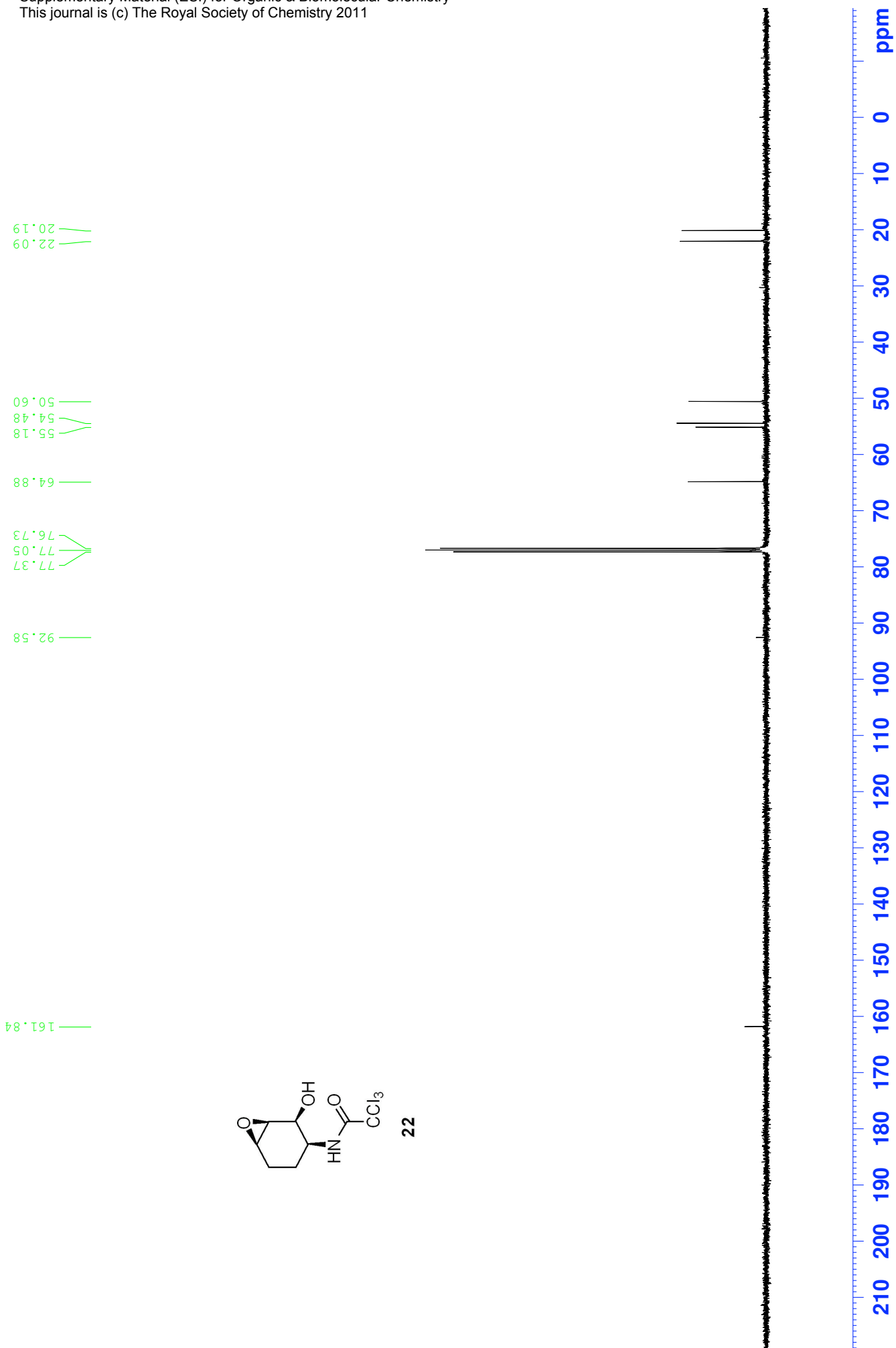

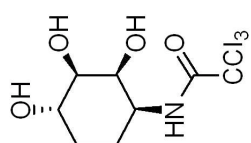

23

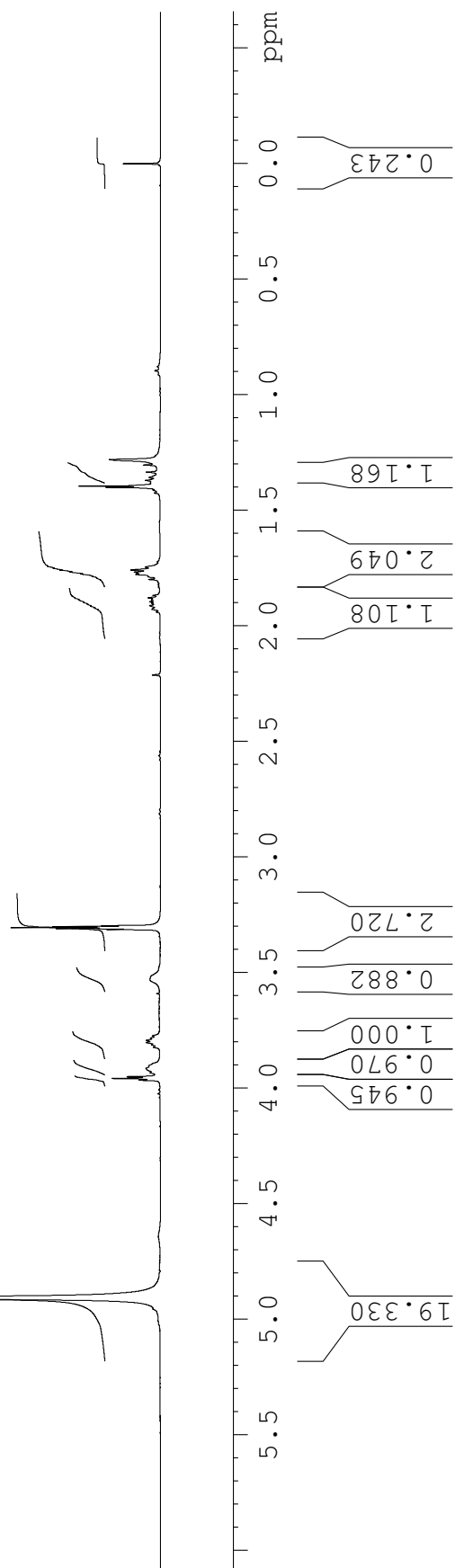

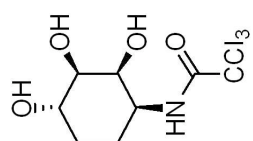

23





