

Electronic Supplementary Information (ESI)

**An Efficient Nickel-Catalyzed Alkenylation of Functionalized Benzylic Halides with
Alkenylaluminum Reagents**

Deepak B. Biradar and Han-Mou Gau*

Department of Chemistry, National Chung Hsing University, Taichung 402, Taiwan

e-mail: hmgau@dragon.nchu.edu.tw

Table of Contents

| | |
|--|------|
| ¹H and ¹³C NMR Spectra of Coupling Products | S-3 |
| 1. (<i>E</i>)-hept-2-enylbenzene (2a) | S-3 |
| 2. (<i>E</i>)-1-(hept-2-enyl)-2-methylbenzene (2b) | S-5 |
| 3. (<i>E</i>)-1-(hept-2-enyl)-3-methylbenzene (2c) | S-7 |
| 4. (<i>E</i>)-1-(hept-2-enyl)-4-methylbenzene (2d) | S-9 |
| 5. (<i>E</i>)-1-(hept-2-enyl)-3-methoxybenzene (2e) | S-11 |
| 6. (<i>E</i>)-1-(hept-2-enyl)-4-methoxybenzene (2f) | S-13 |
| 7. (<i>E</i>)-(4-(hept-2-enyl)phenyl)(methyl)sulfane (2g) | S-15 |
| 8. (<i>E</i>)-1- <i>tert</i> -butyl-4-(hept-2-enyl)benzene (2h) | S-17 |
| 9. (<i>E</i>)-2-(hept-2-enyl)biphenyl (2i) | S-19 |
| 10. (<i>E</i>)-3-(hept-2-enyl)biphenyl (2j) | S-21 |
| 11. (<i>E</i>)-1-(hept-2-enyl)-3,5-dimethoxybenzene (2k) | S-23 |
| 12. (<i>E</i>)-1-chloro-4-(hept-2-enyl)benzene (2l) | S-25 |
| 13. (<i>E</i>)-1-(hept-2-enyl)-3,5-bis(trifluoromethyl)benzene (2m) | S-27 |
| 14. (<i>E</i>)-methyl 4-(hept-2-enyl)benzoate (2n) | S-29 |
| 15. (<i>E</i>)-1,4-diphenylbut-2-ene (2o) | S-31 |
| 16. (<i>E</i>)-(3-cyclohexylallyl)benzene (2p) | S-33 |
| 17. (<i>E</i>)-3-(3-phenylprop-1-enyl)thiophene (2q) | S-35 |
| 18. (<i>E</i>)-1-fluoro-4-(hept-2-enyl)benzene (2r) | S-37 |
| 19. (<i>E</i>)-1-(hept-2-enyl)-4-vinylbenzene (2s) | S-39 |

^1H and ^{13}C NMR Spectra of Coupling Products

1. (*E*)-hept-2-enylbenzene (2a)

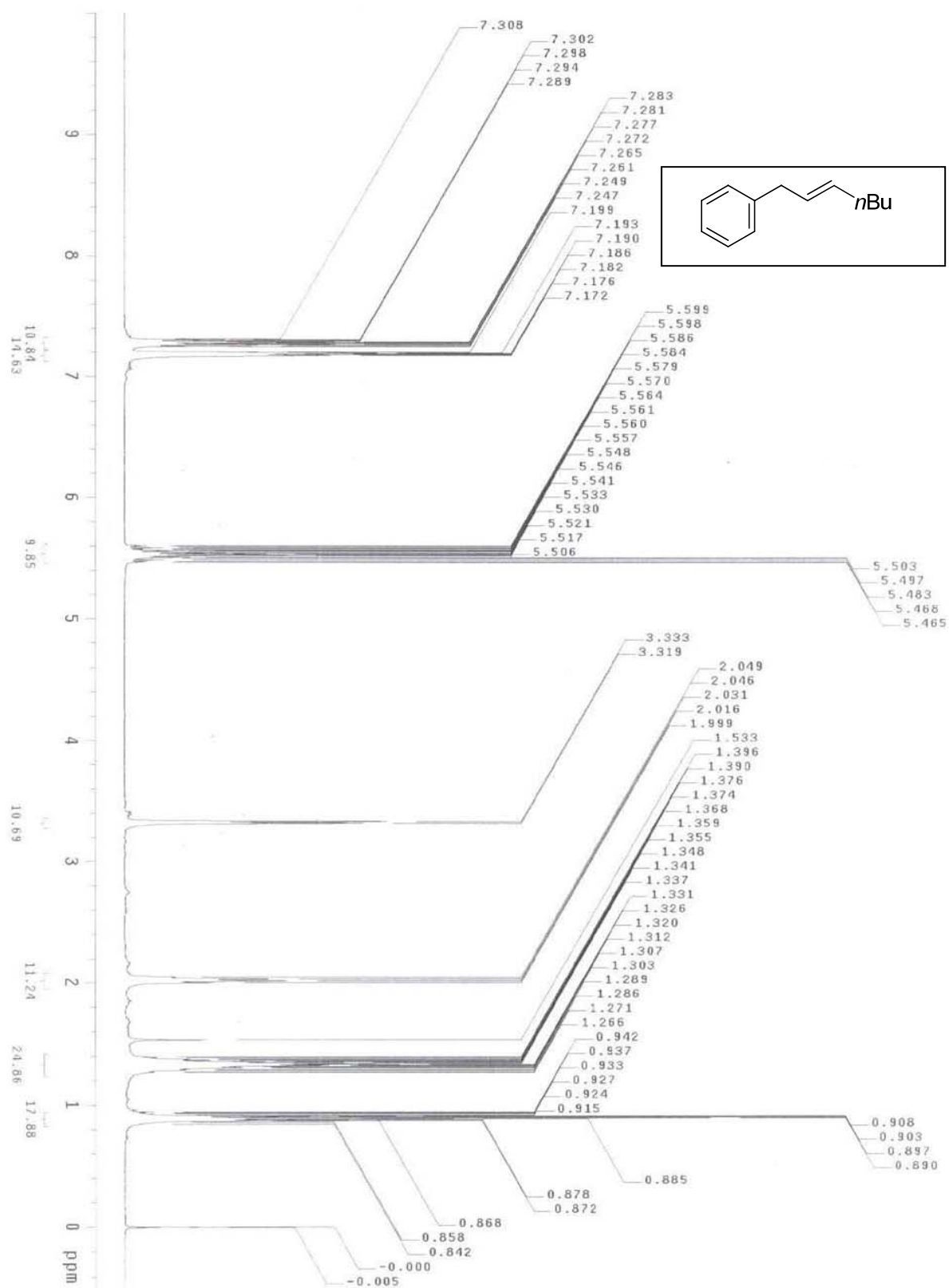

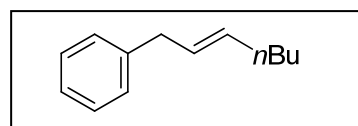
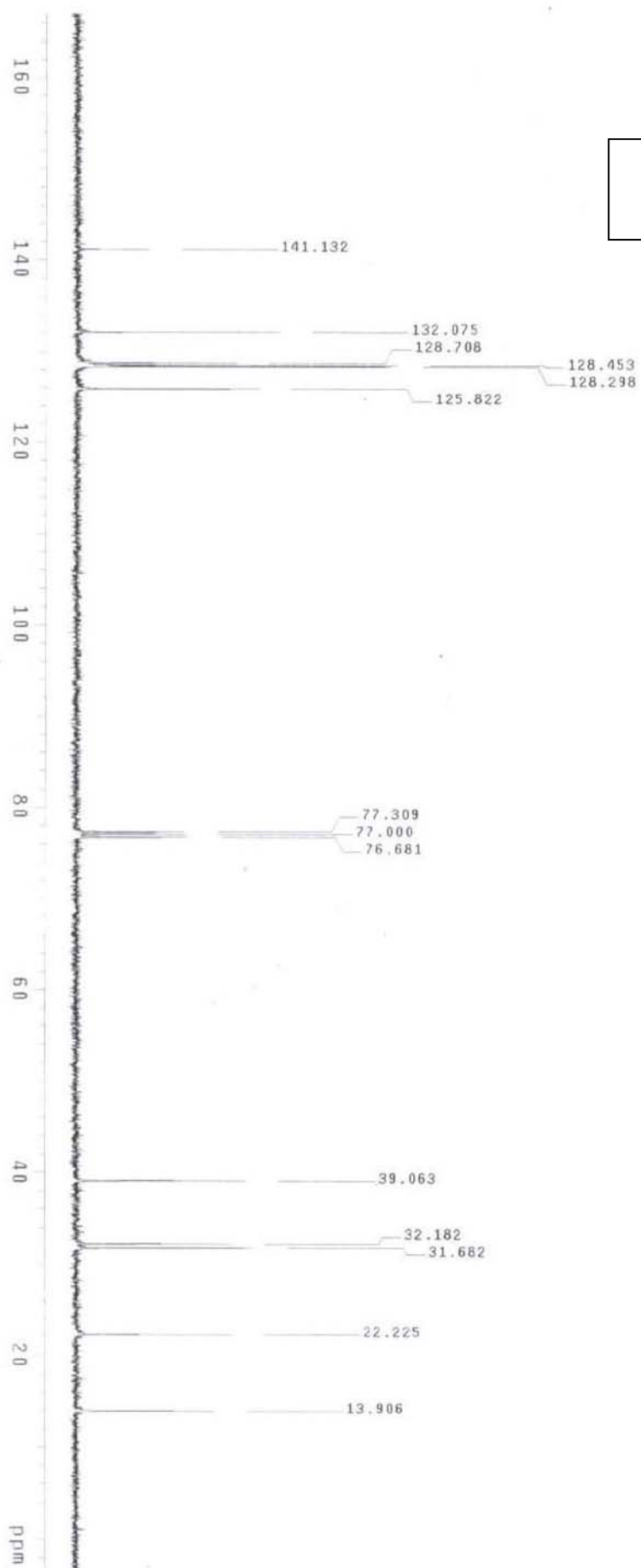

2. (E)-1-(hept-2-enyl)-2-methylbenzene (2b)

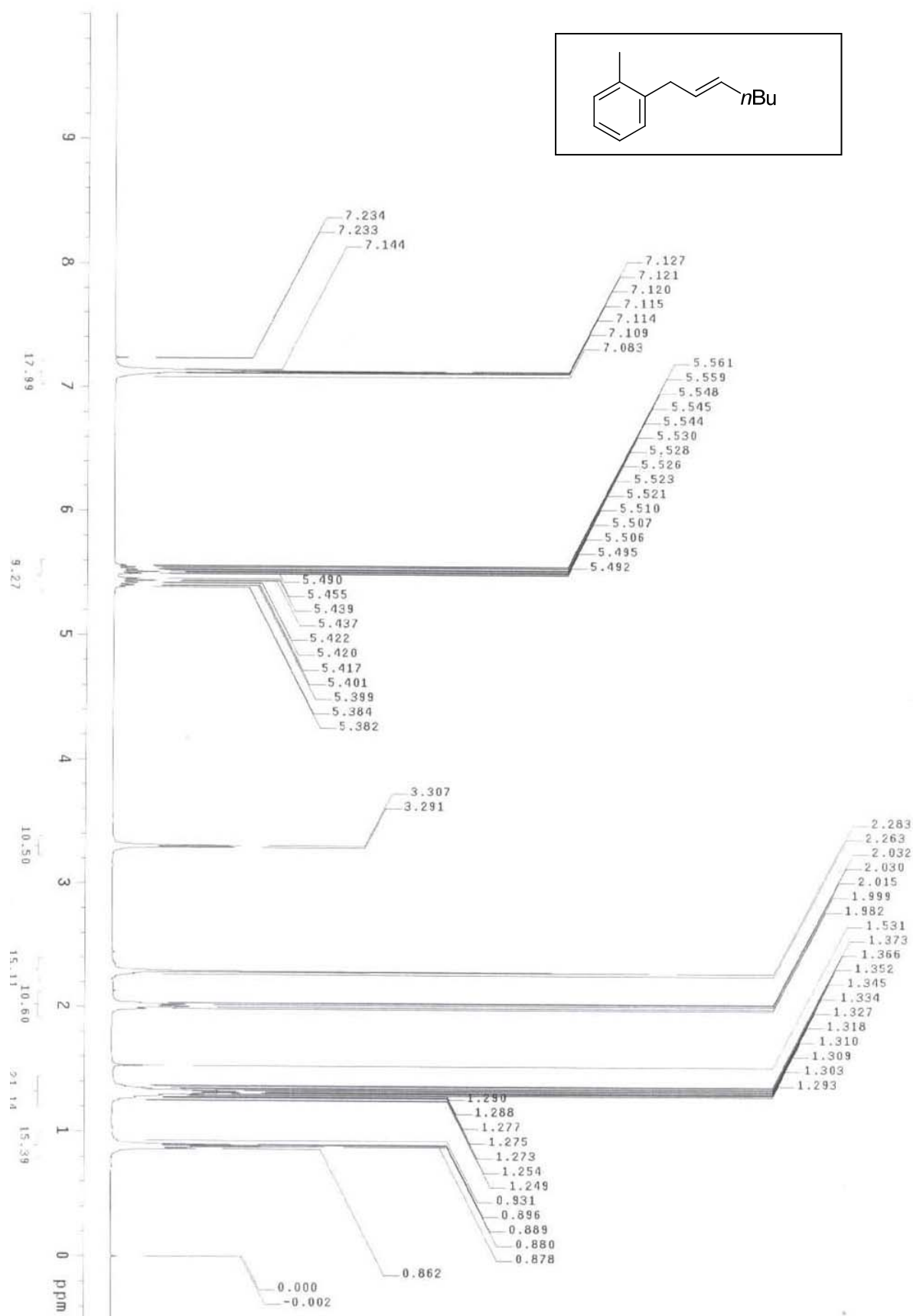

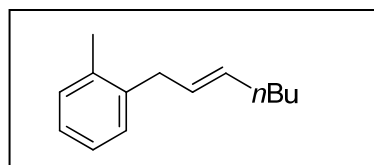
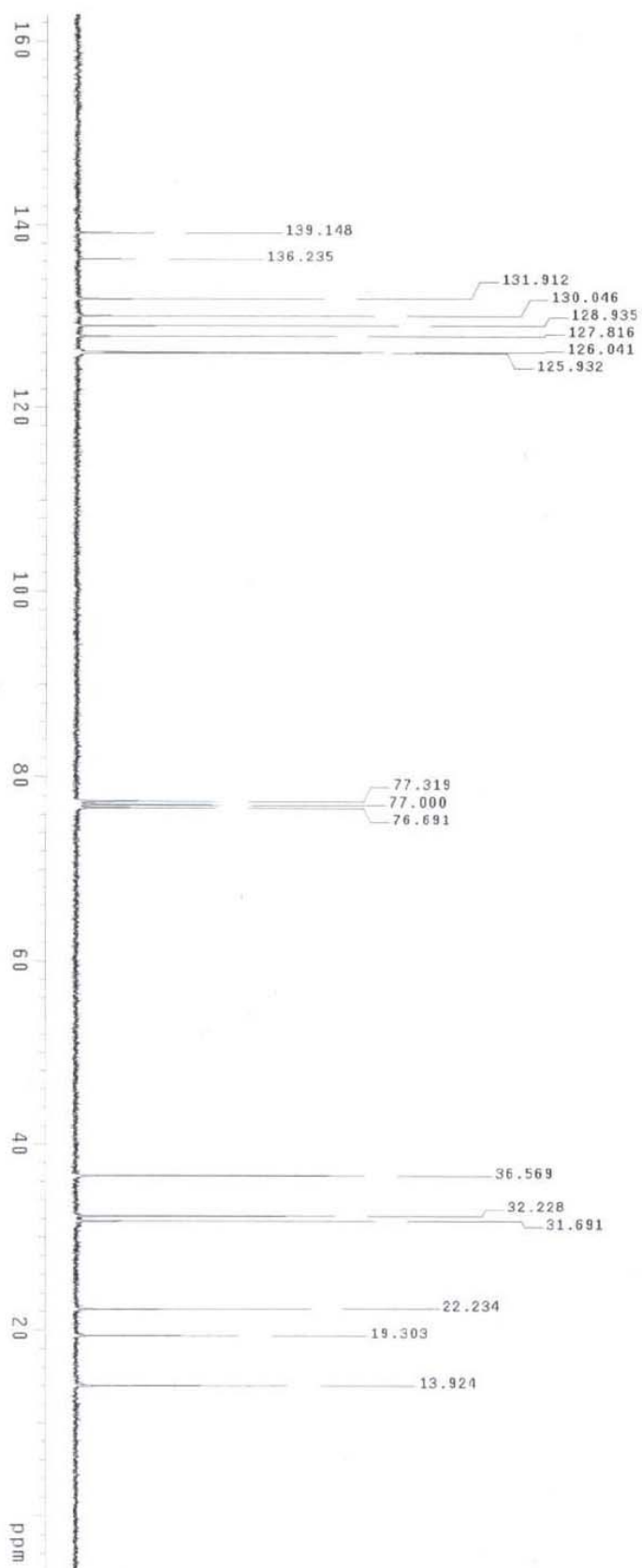

3. (E)-1-(hept-2-enyl)-3-methylbenzene (2c)

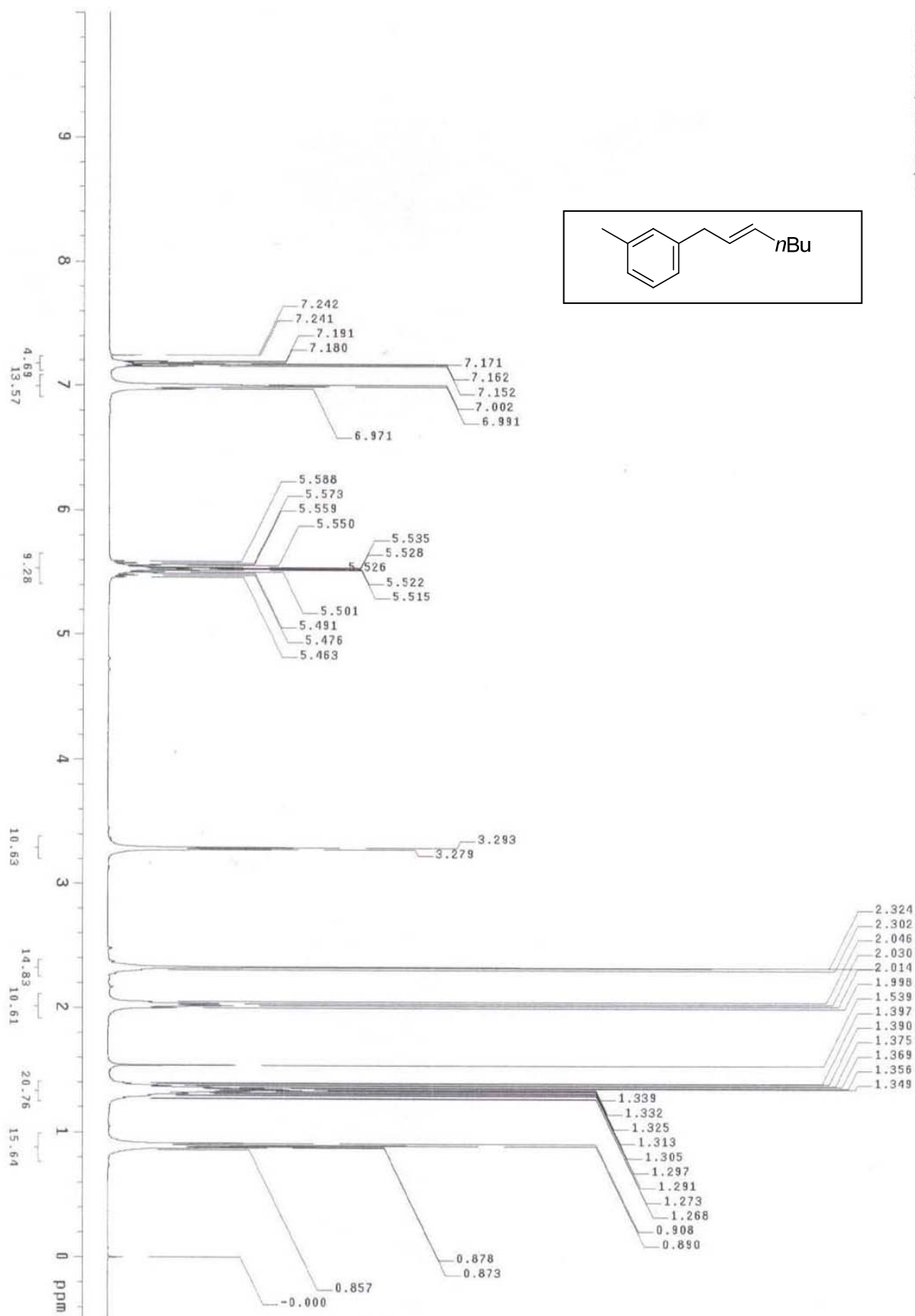

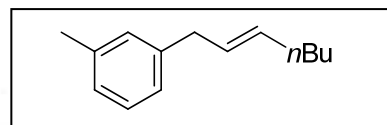
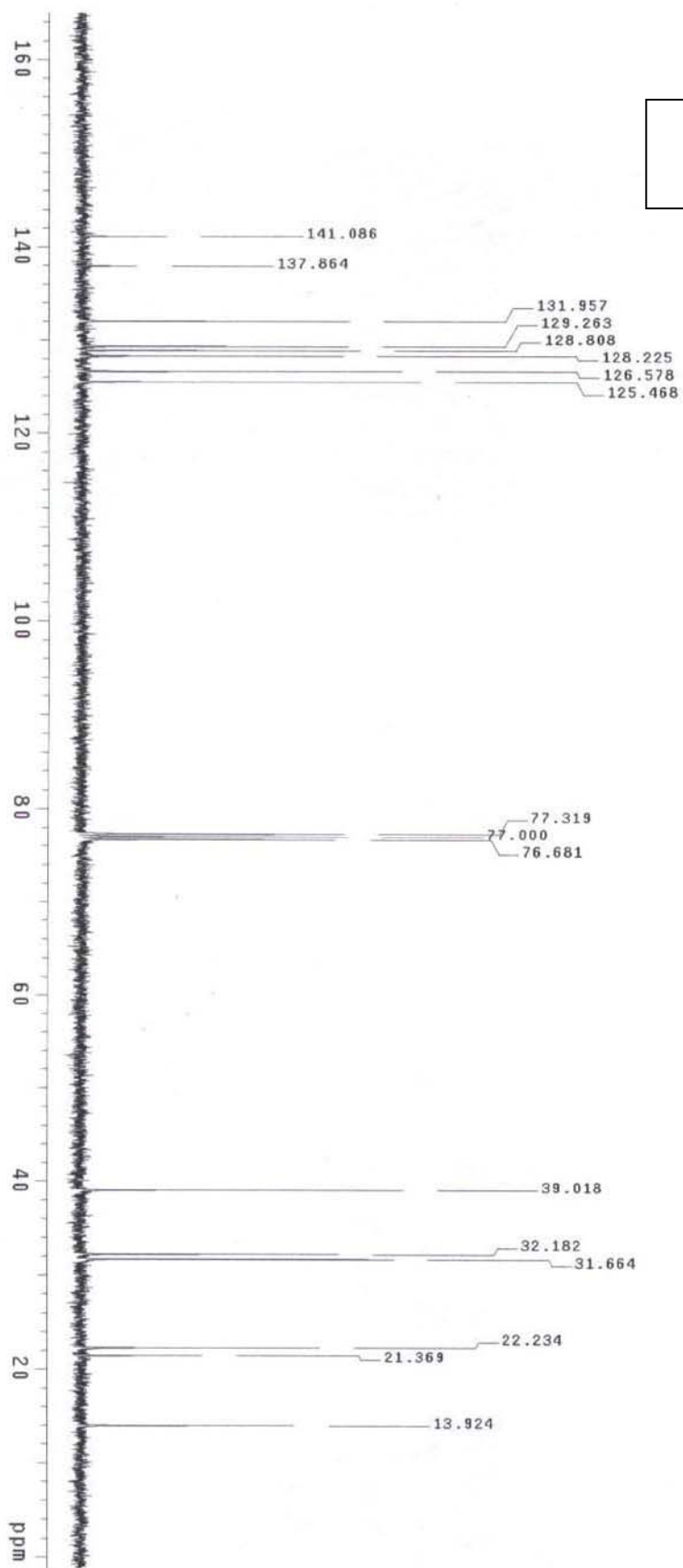

4. (E)-1-(hept-2-enyl)-4-methylbenzene (2d)

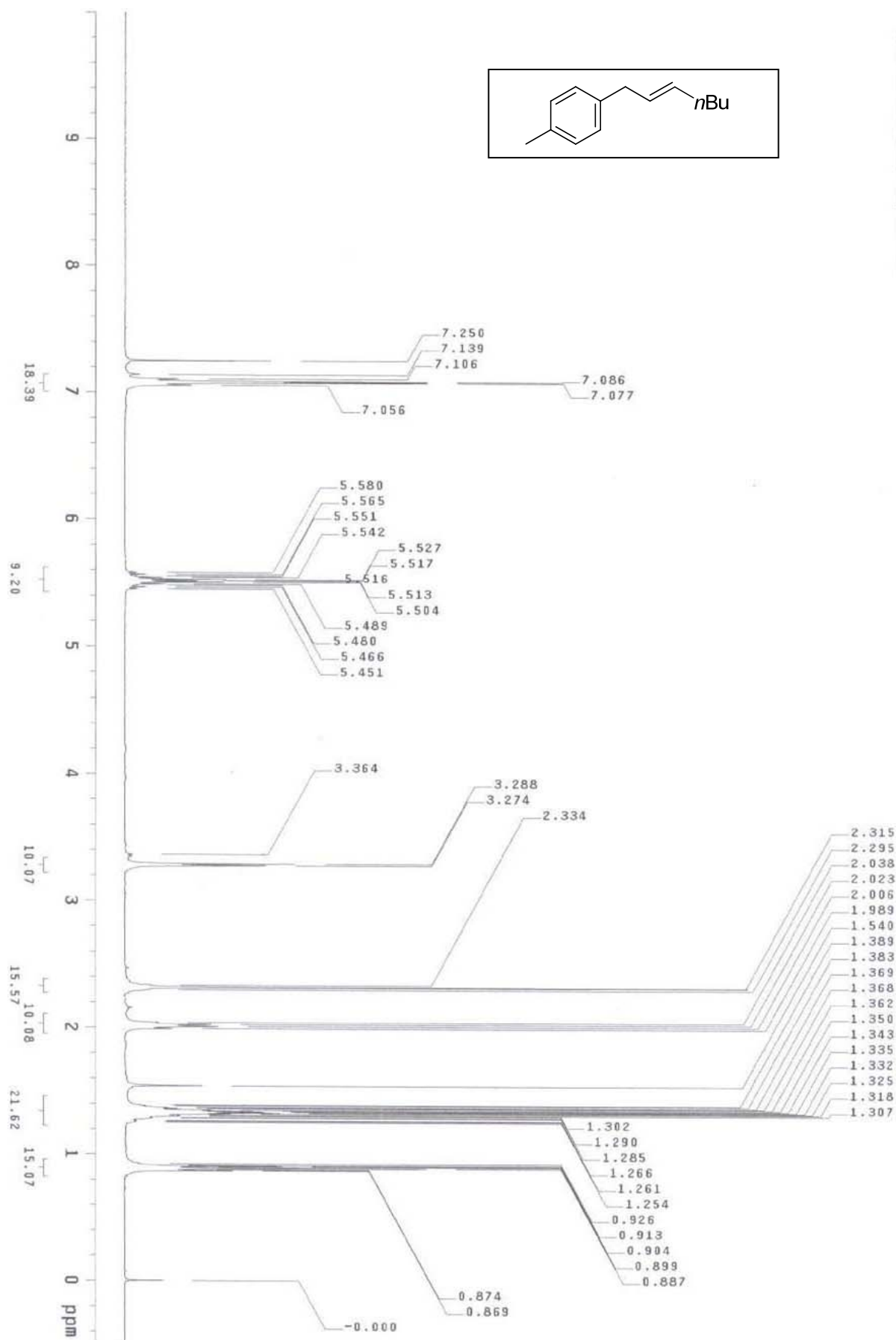

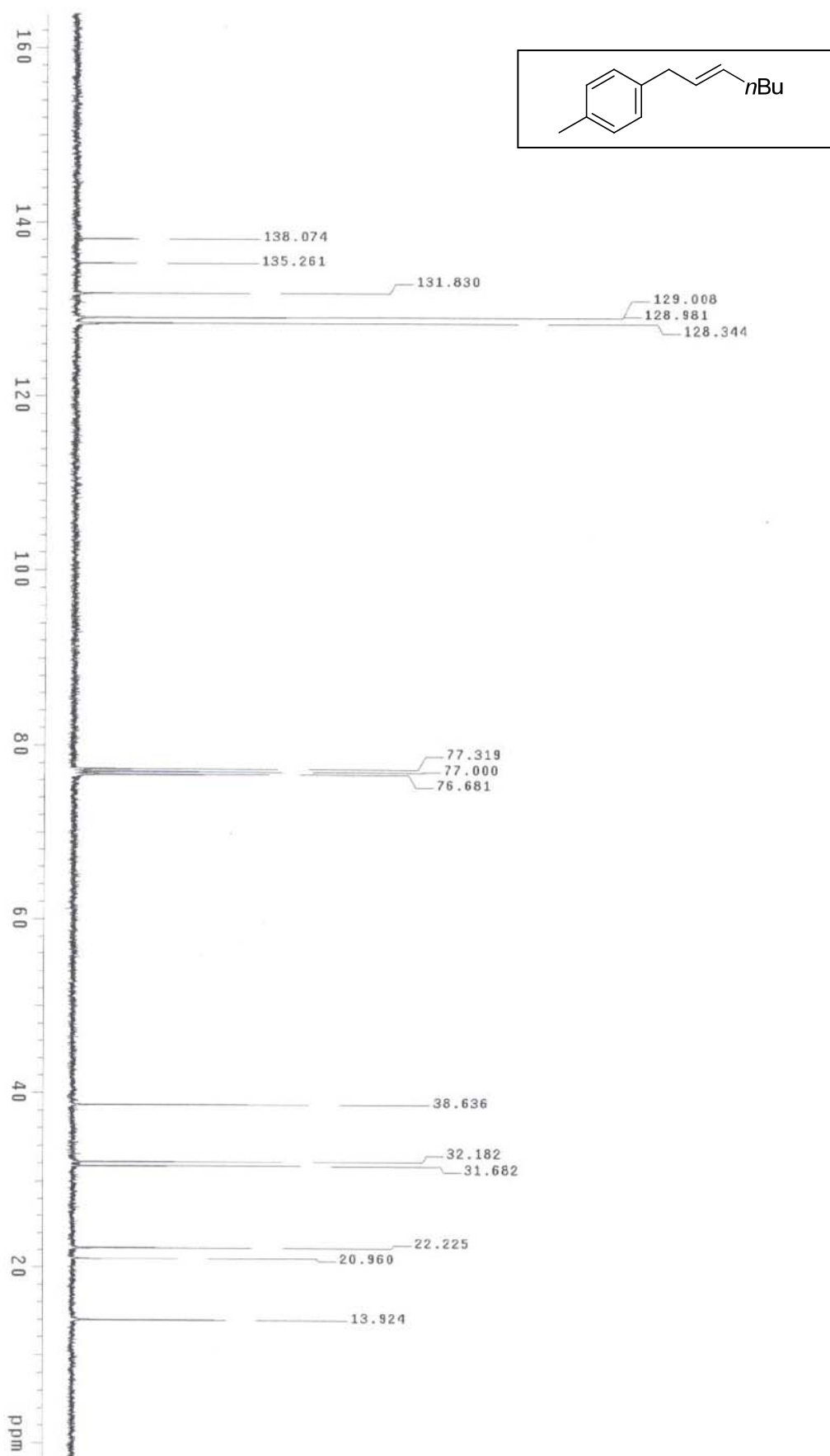

5. (*E*)-1-(hept-2-enyl)-3-methoxybenzene (2e)

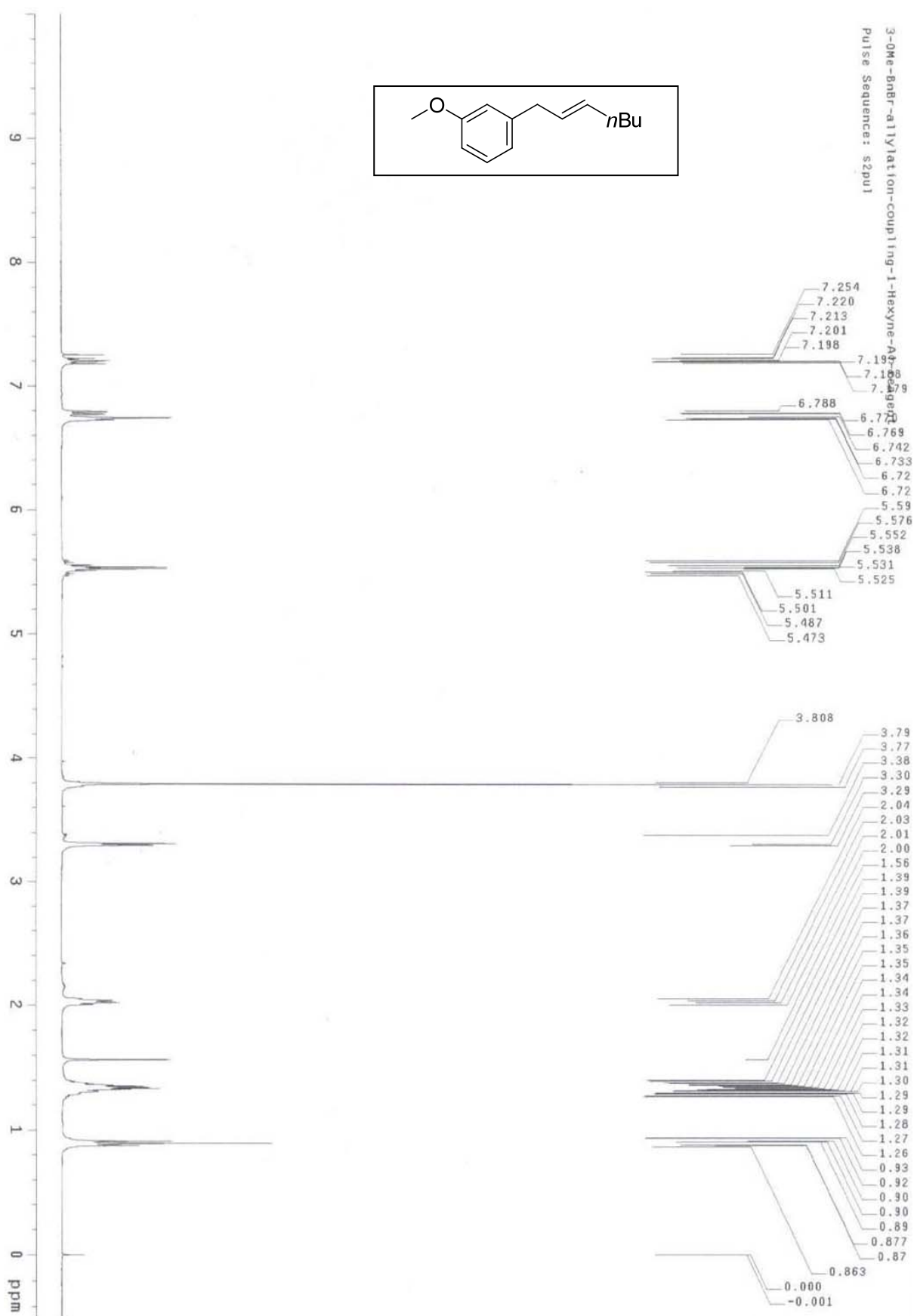

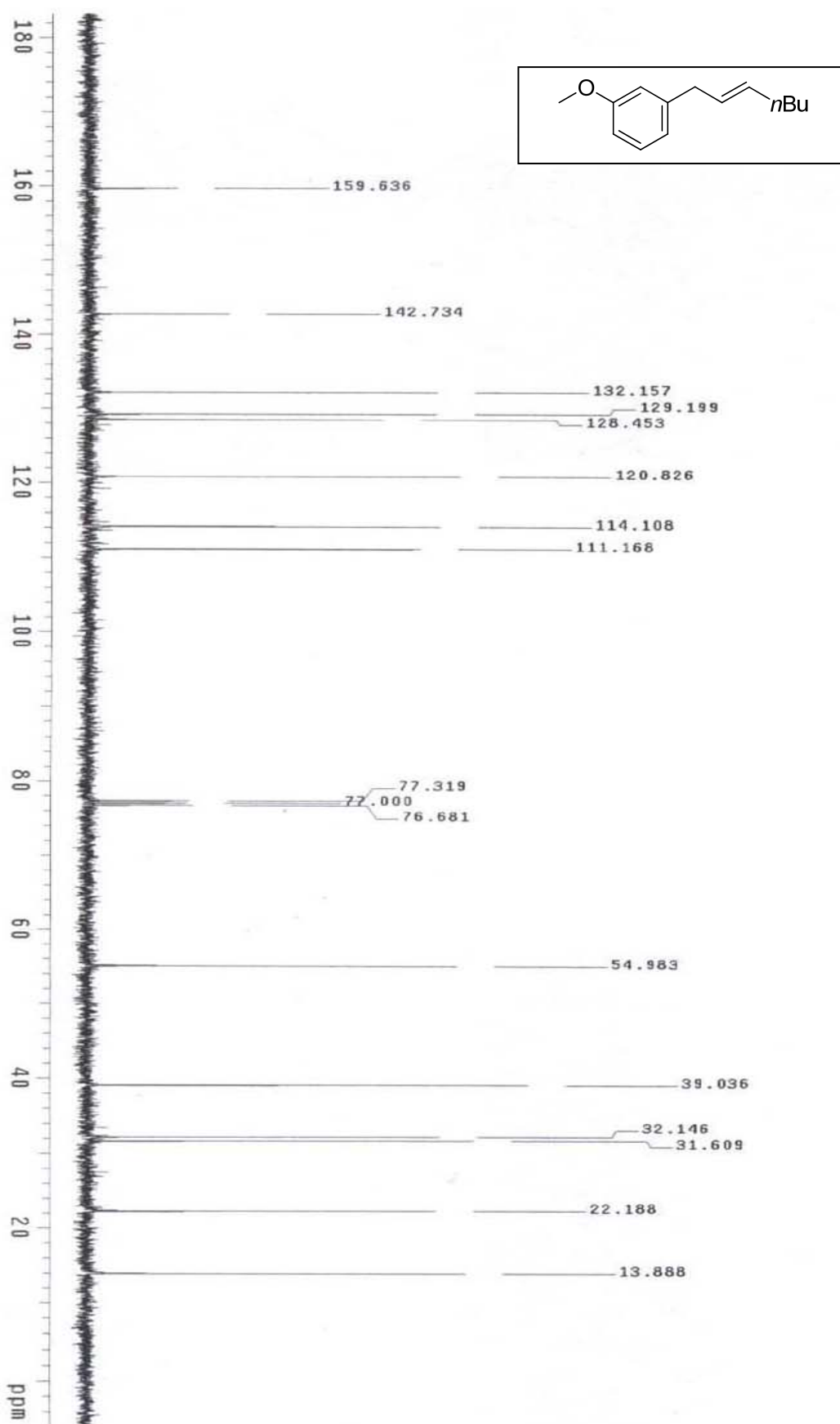

6. (E)-1-(hept-2-enyl)-4-methoxybenzene (2f)

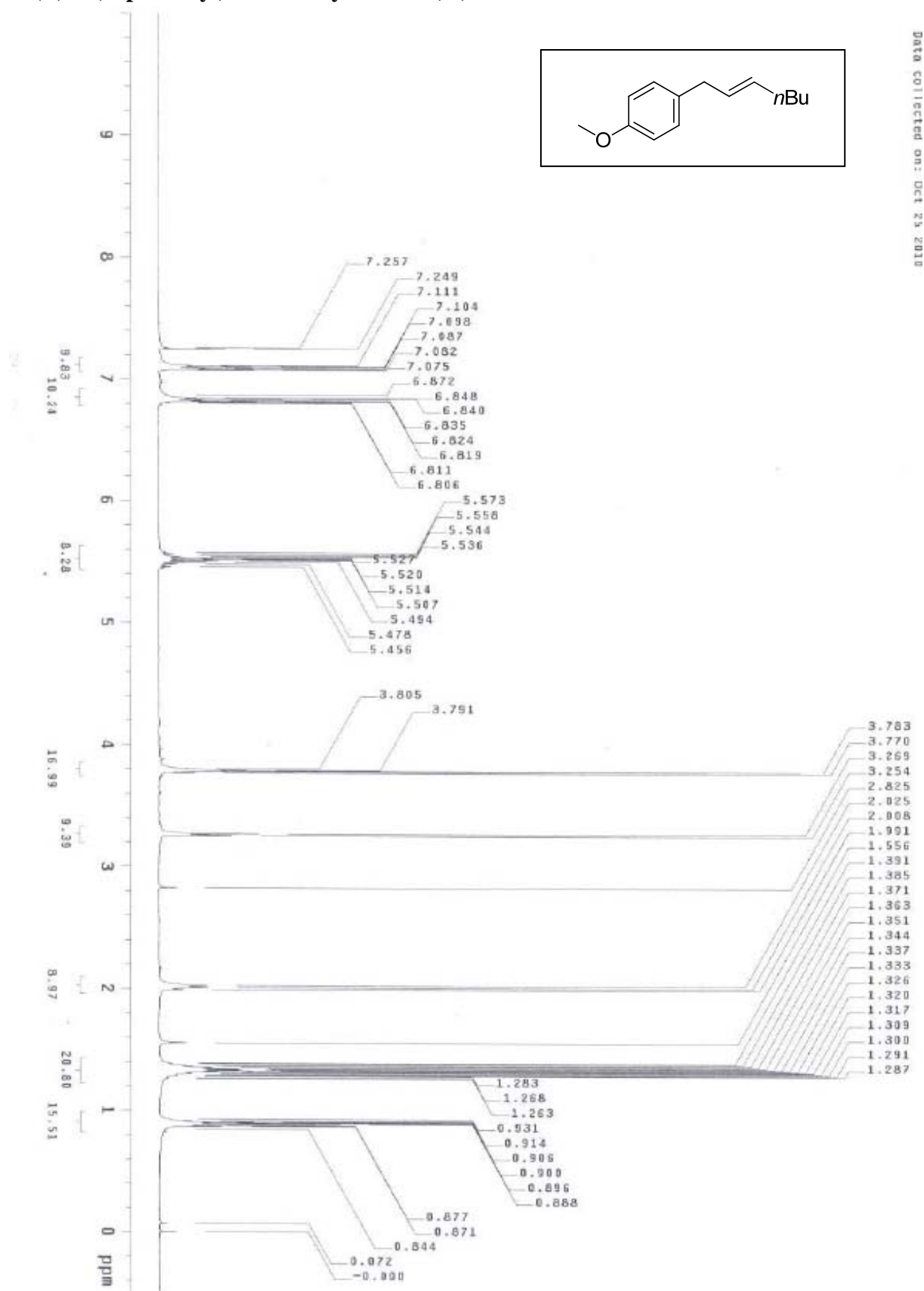

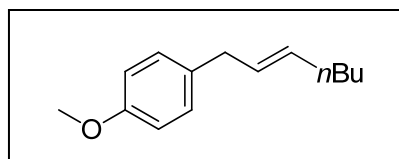
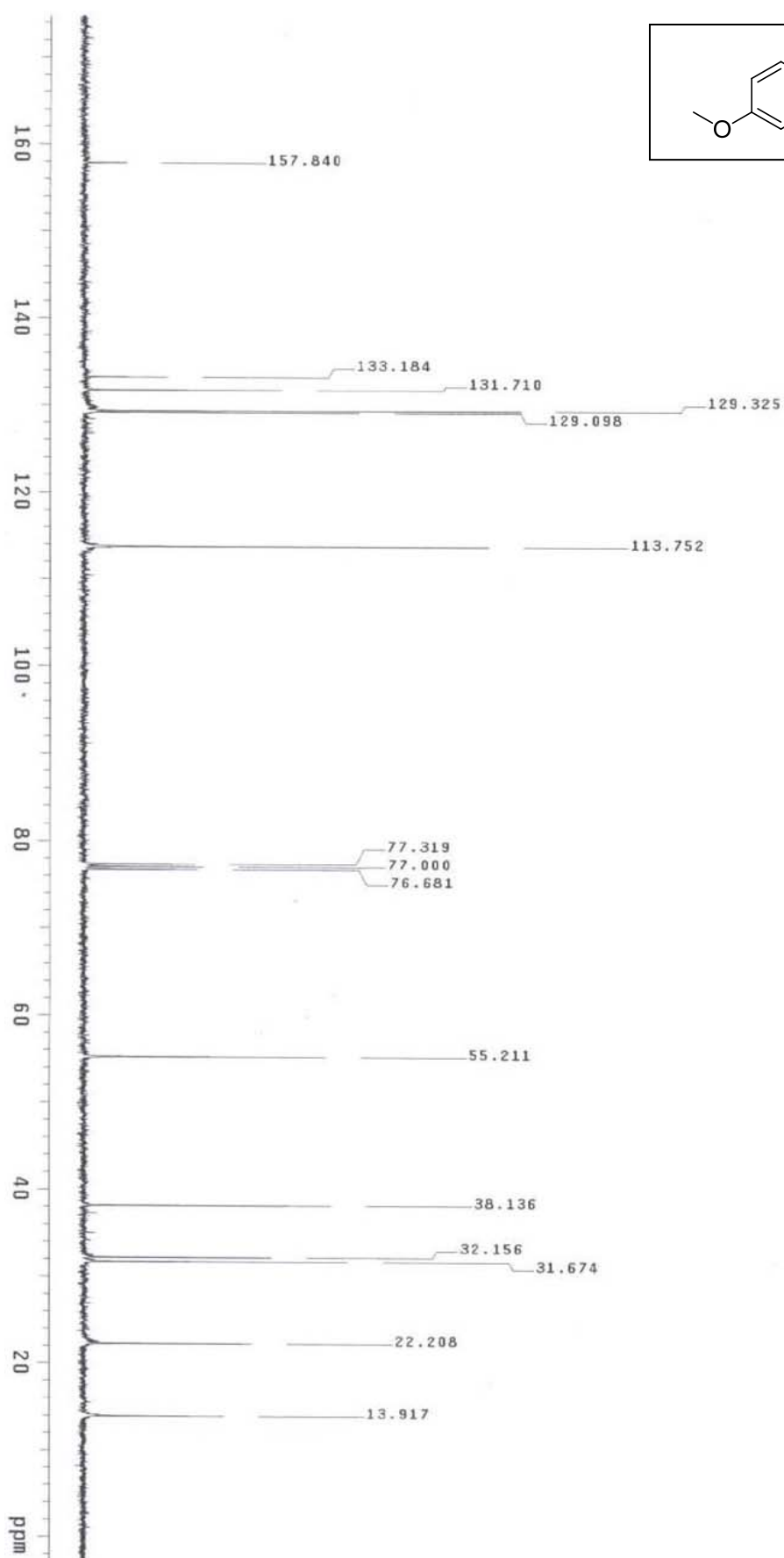

7. (E)-4-(hept-2-enyl)phenyl(methyl)sulfane (2g)

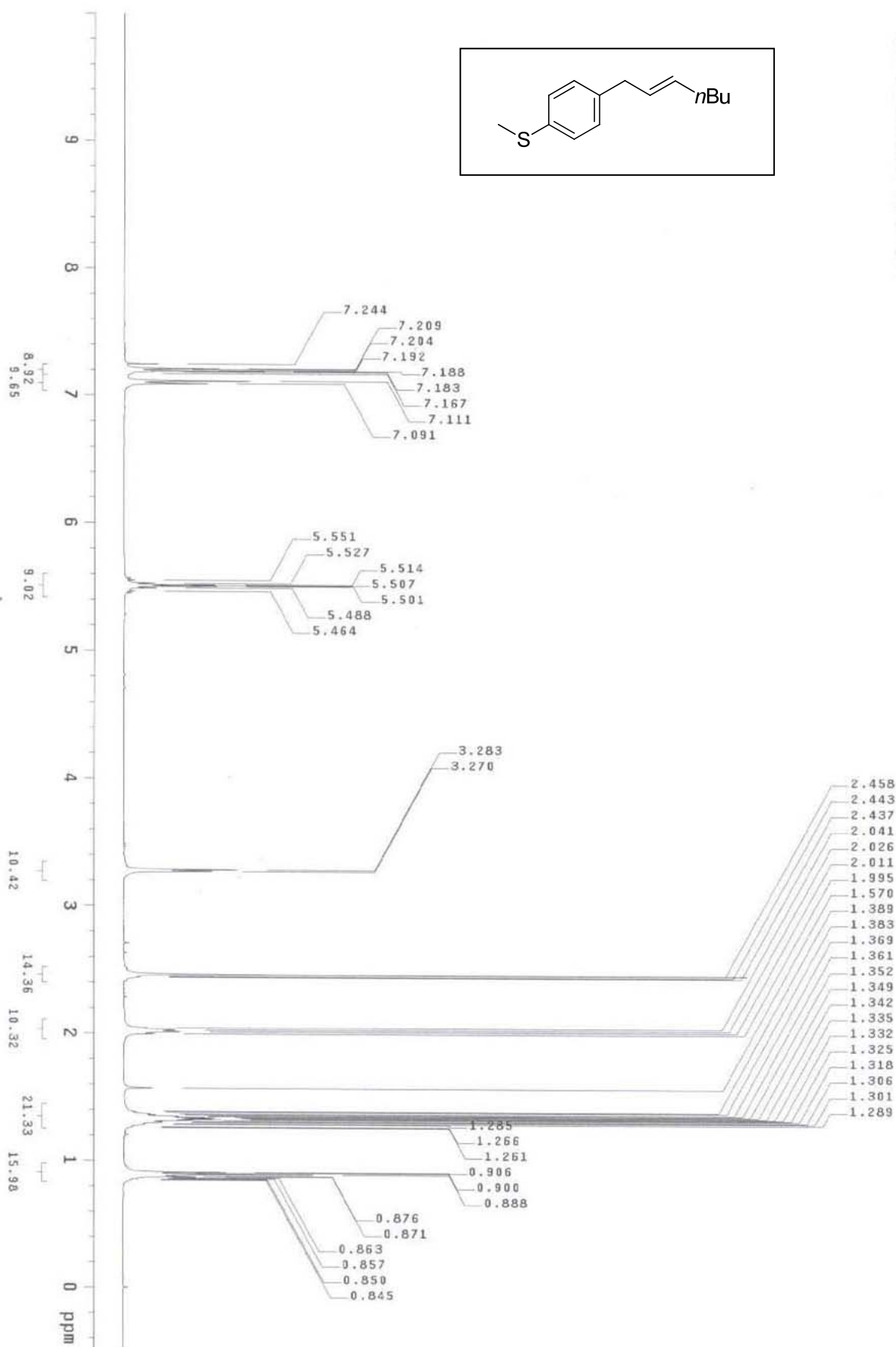

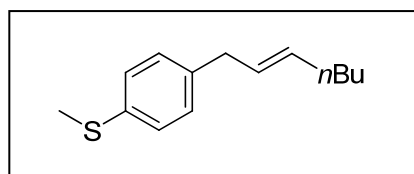
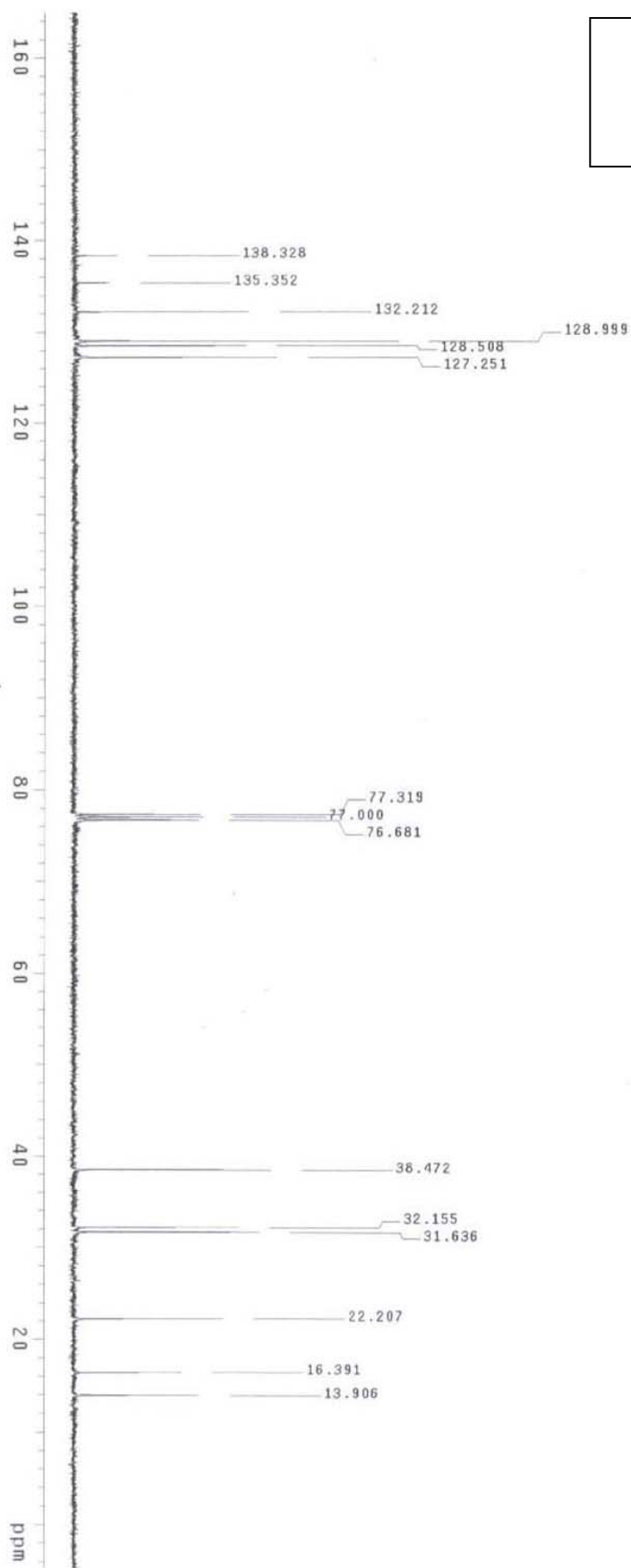

8. (E)-1-tert-butyl-4-(hept-2-enyl)benzene (2h)

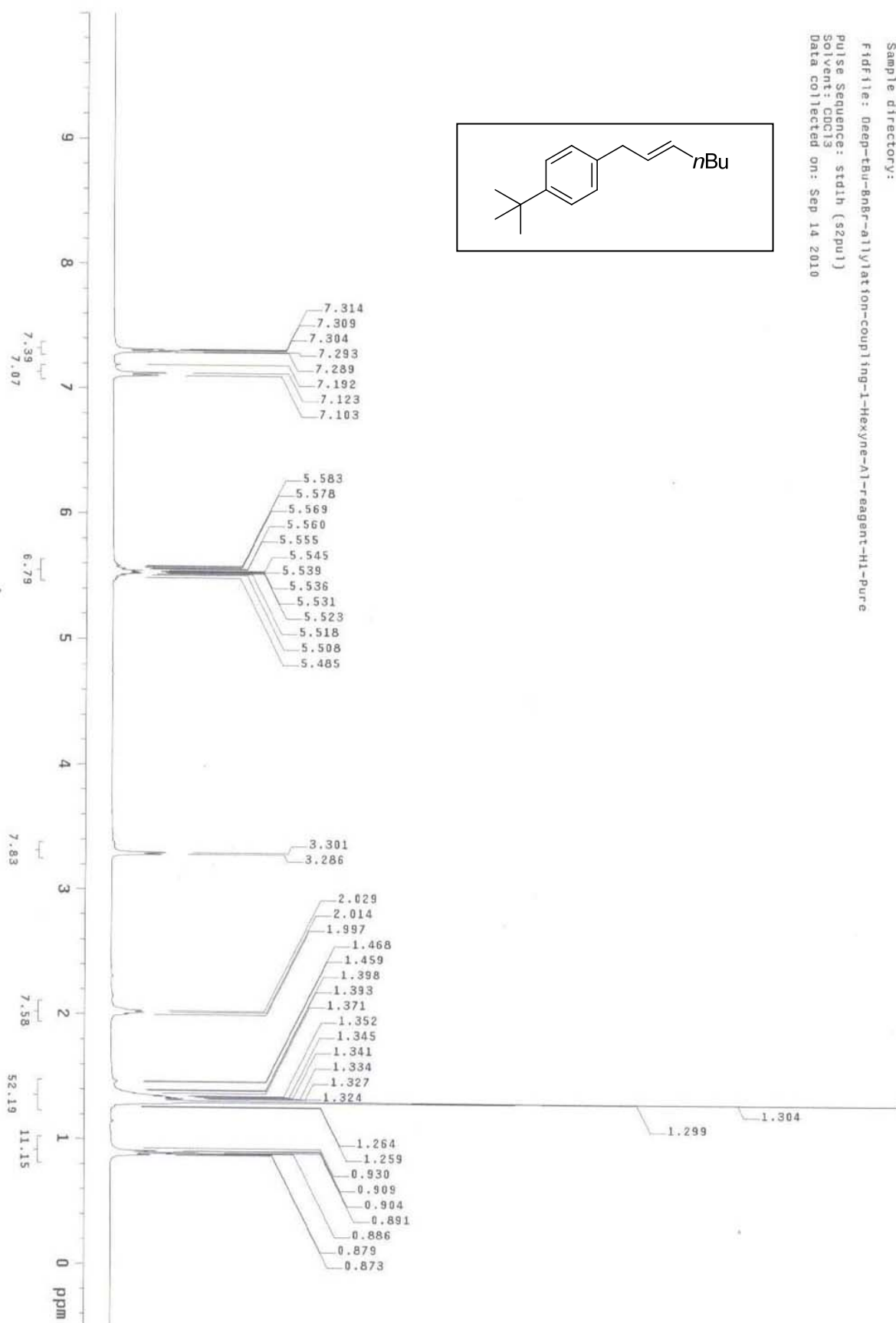

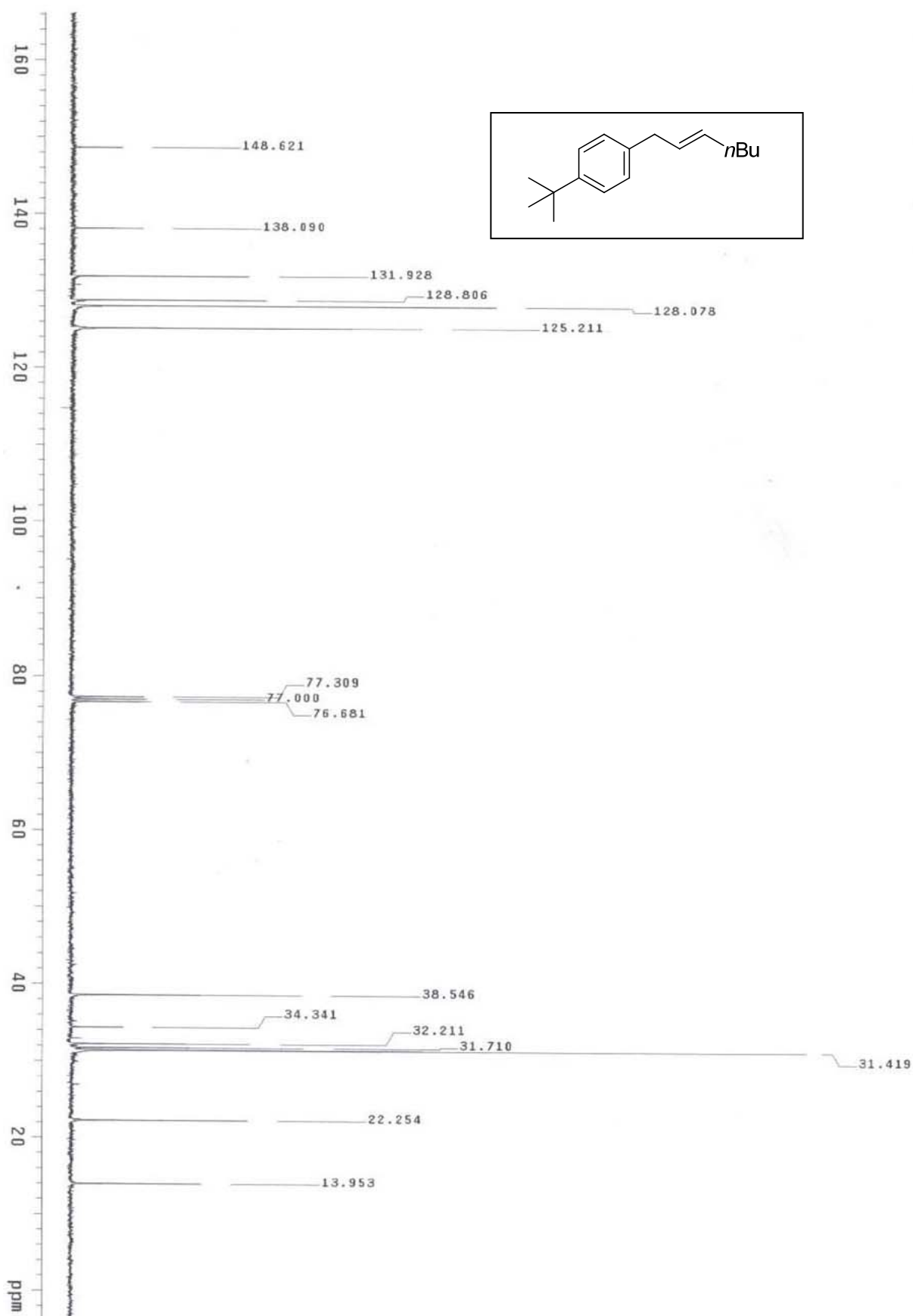

9. (E)-2-(hept-2-enyl)biphenyl (2i)

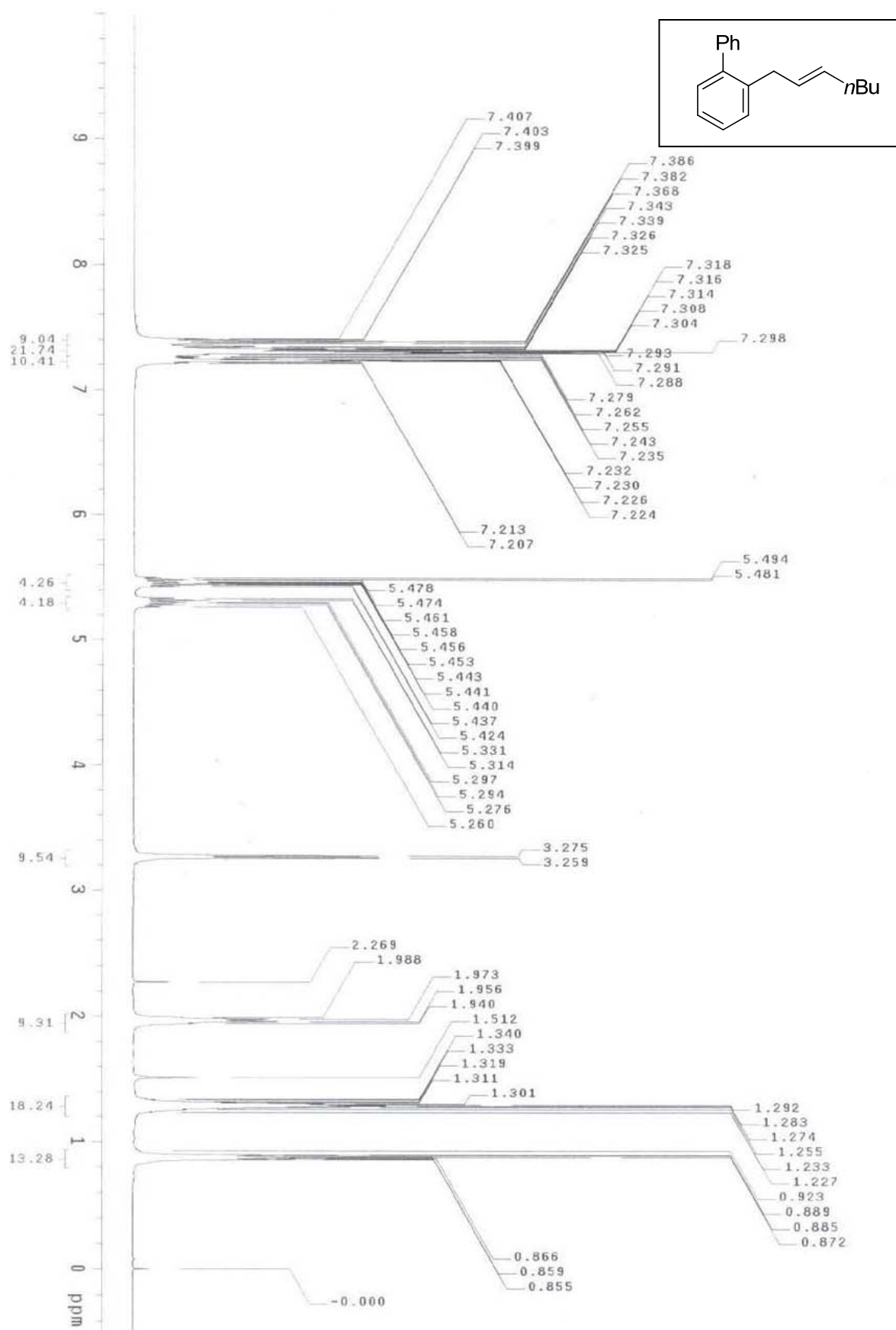

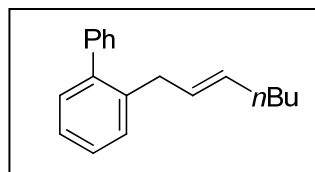
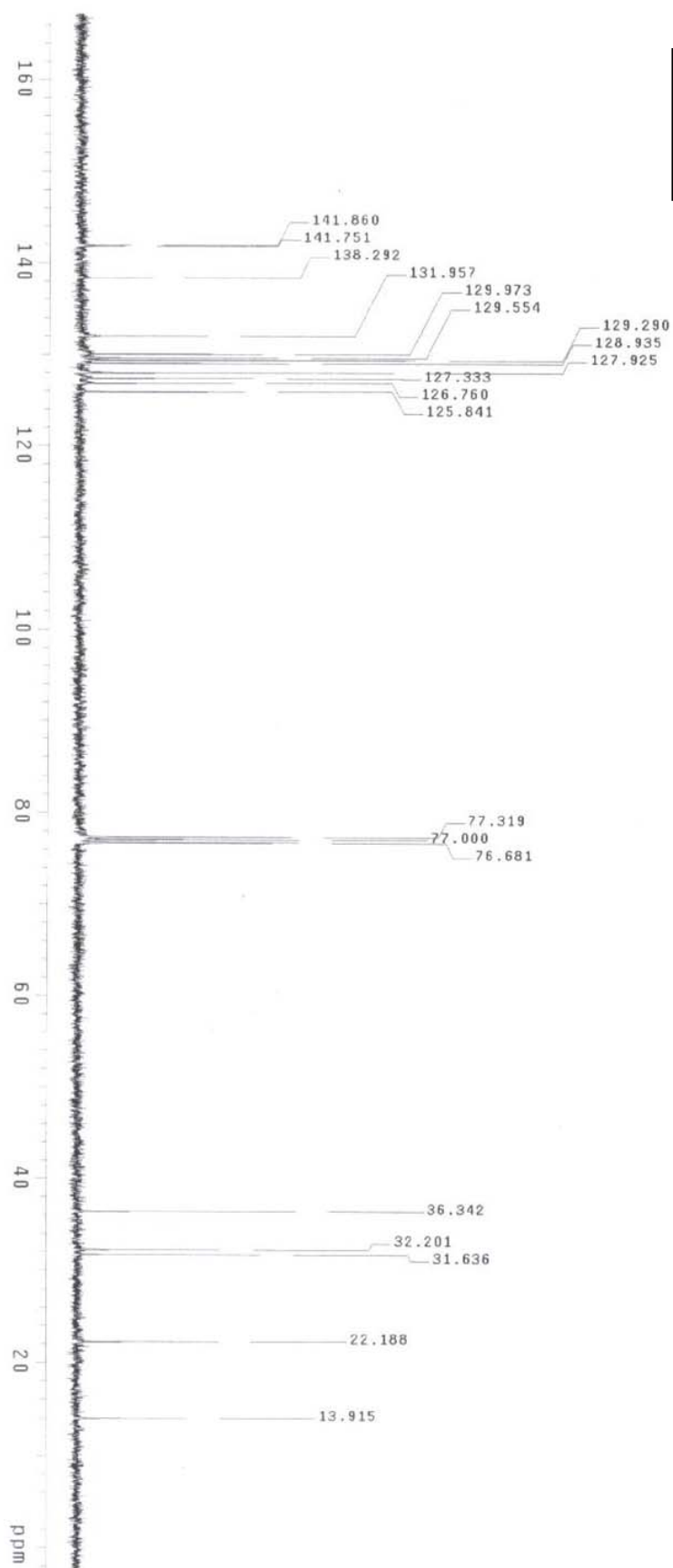

10. (*E*)-3-(hept-2-enyl)biphenyl (2j)

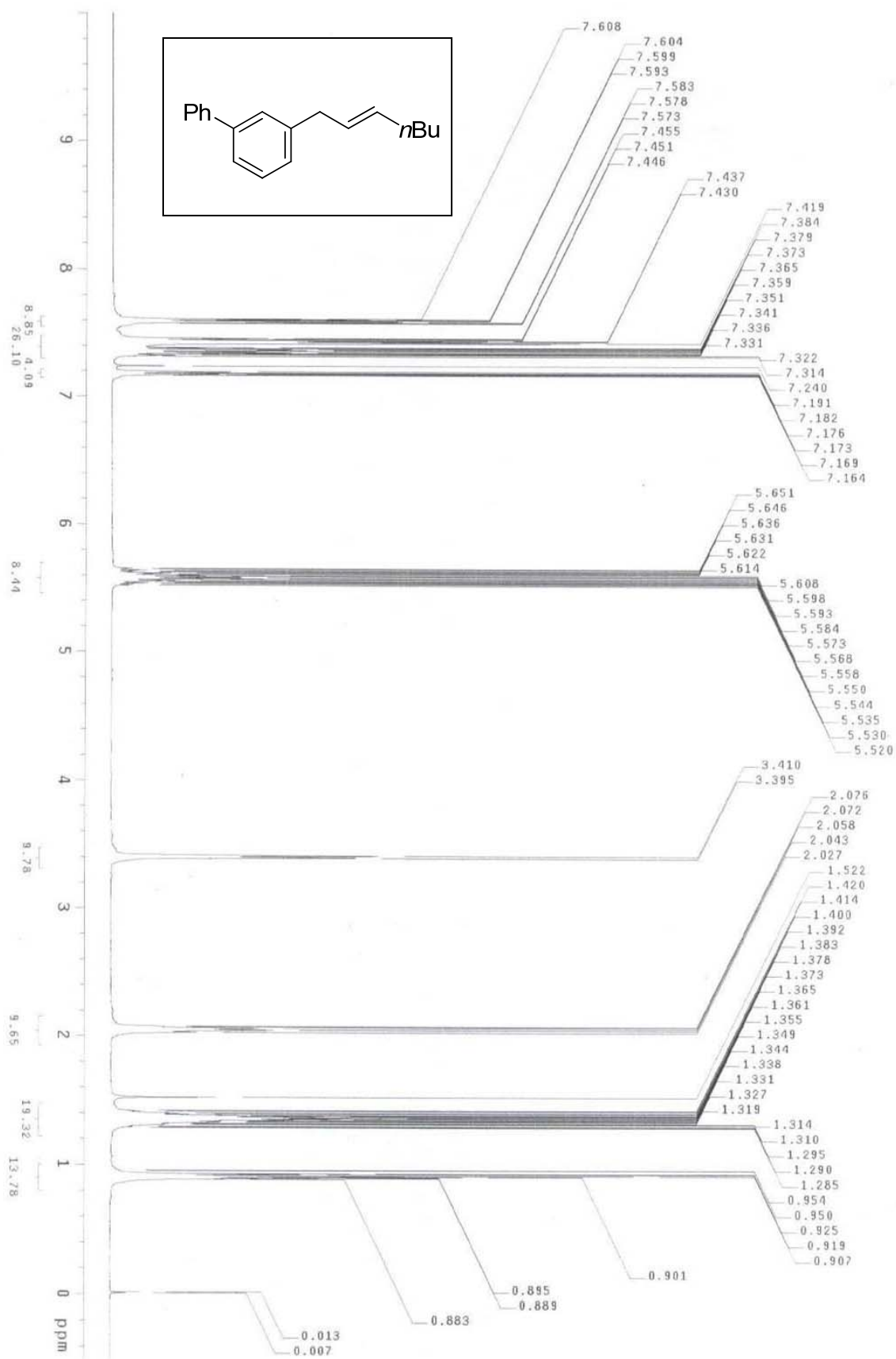

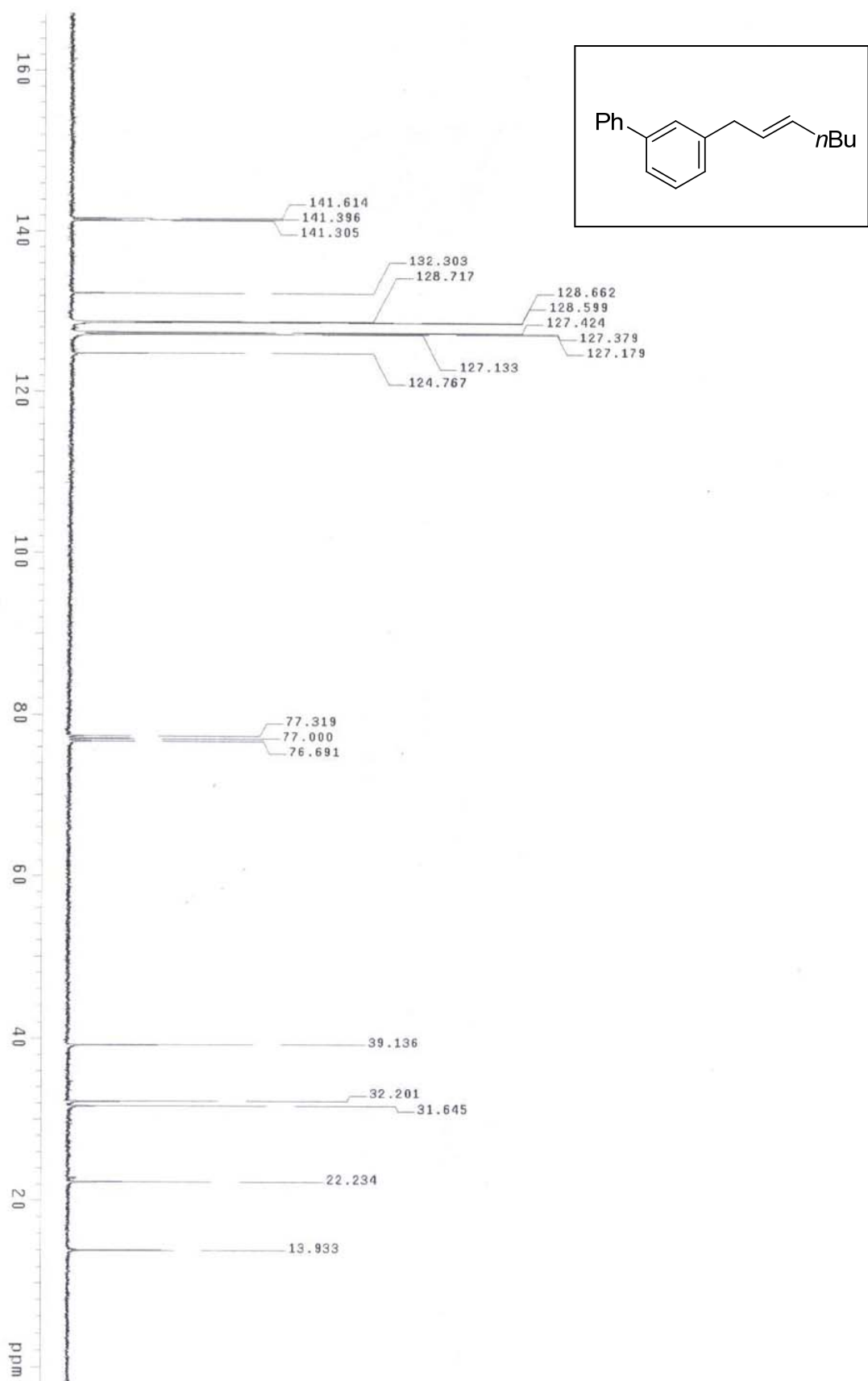

11. (*E*)-1-(hept-2-enyl)-3,5-dimethoxybenzene (2k)

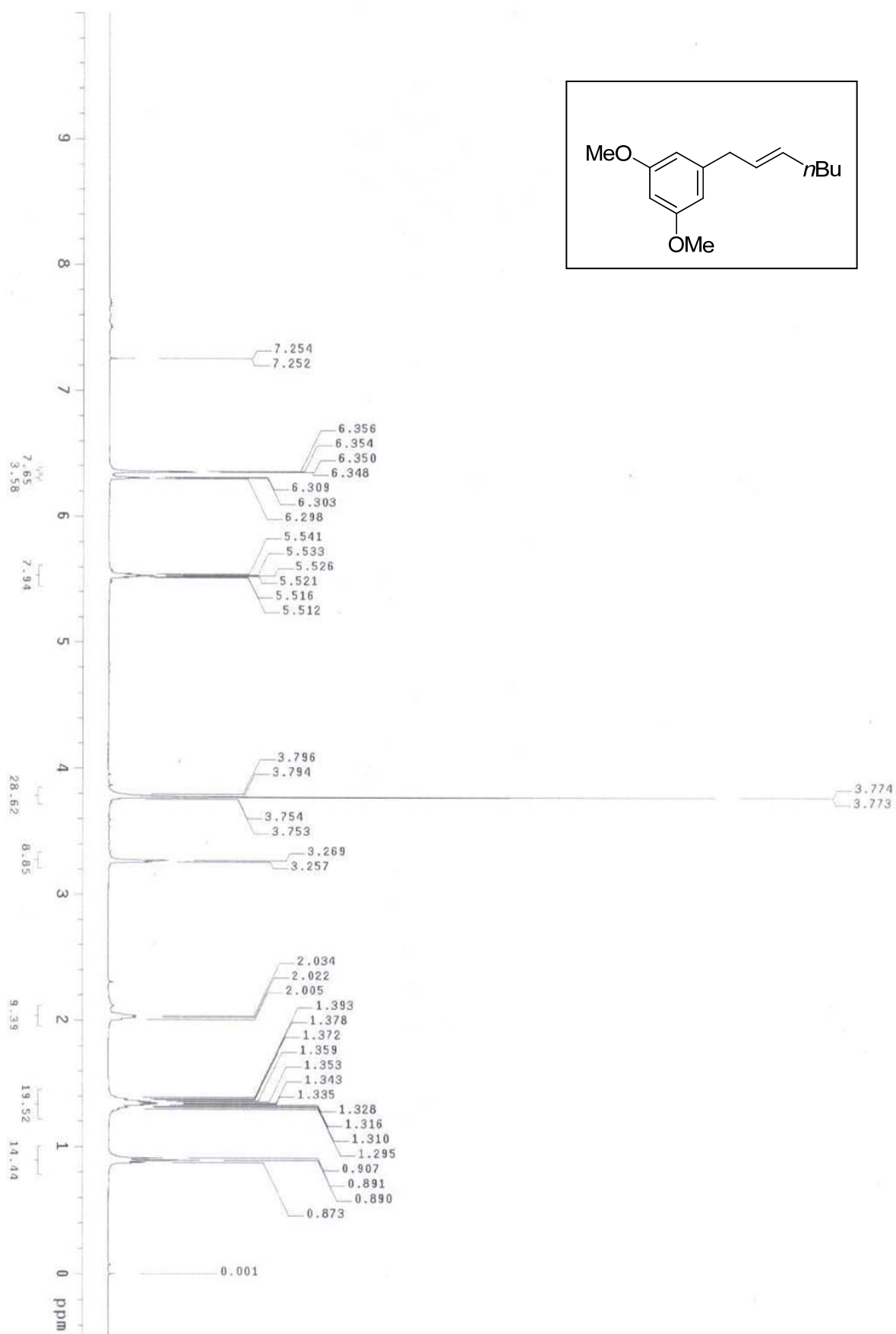

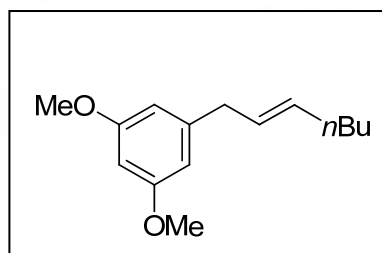
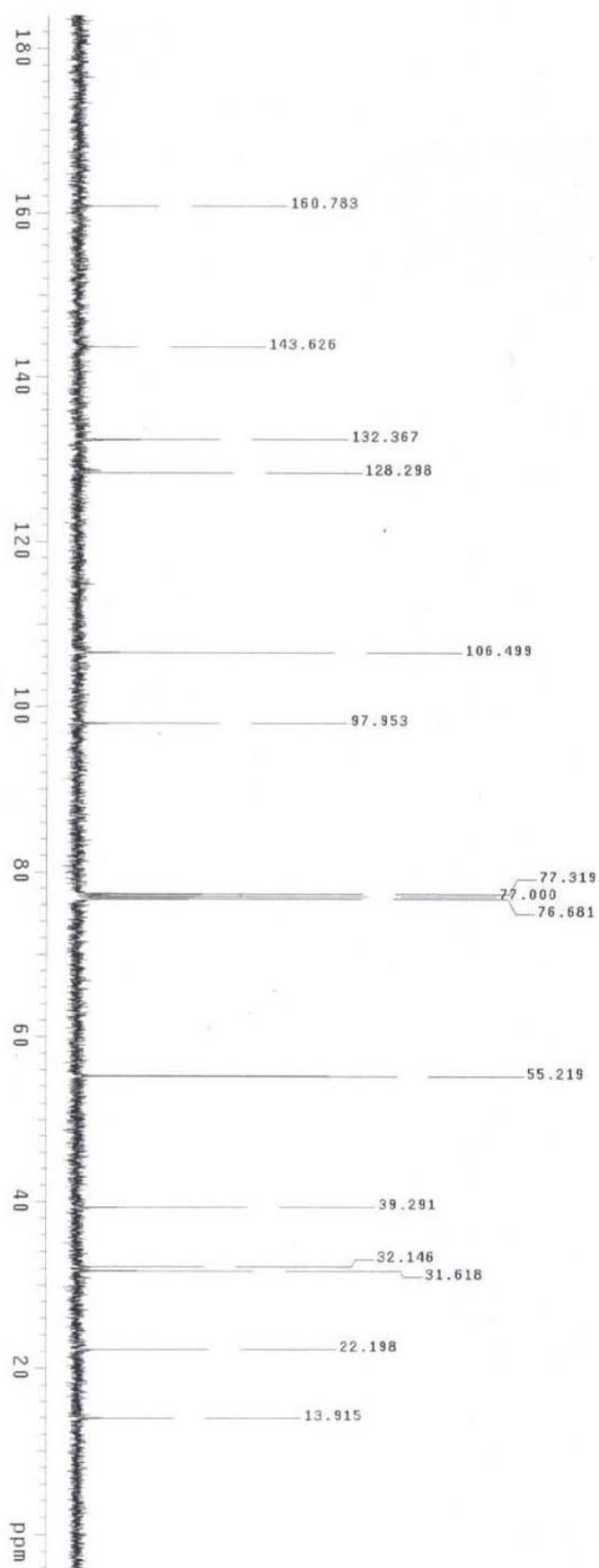

12. (E)-1-chloro-4-(hept-2-enyl)benzene (2l)

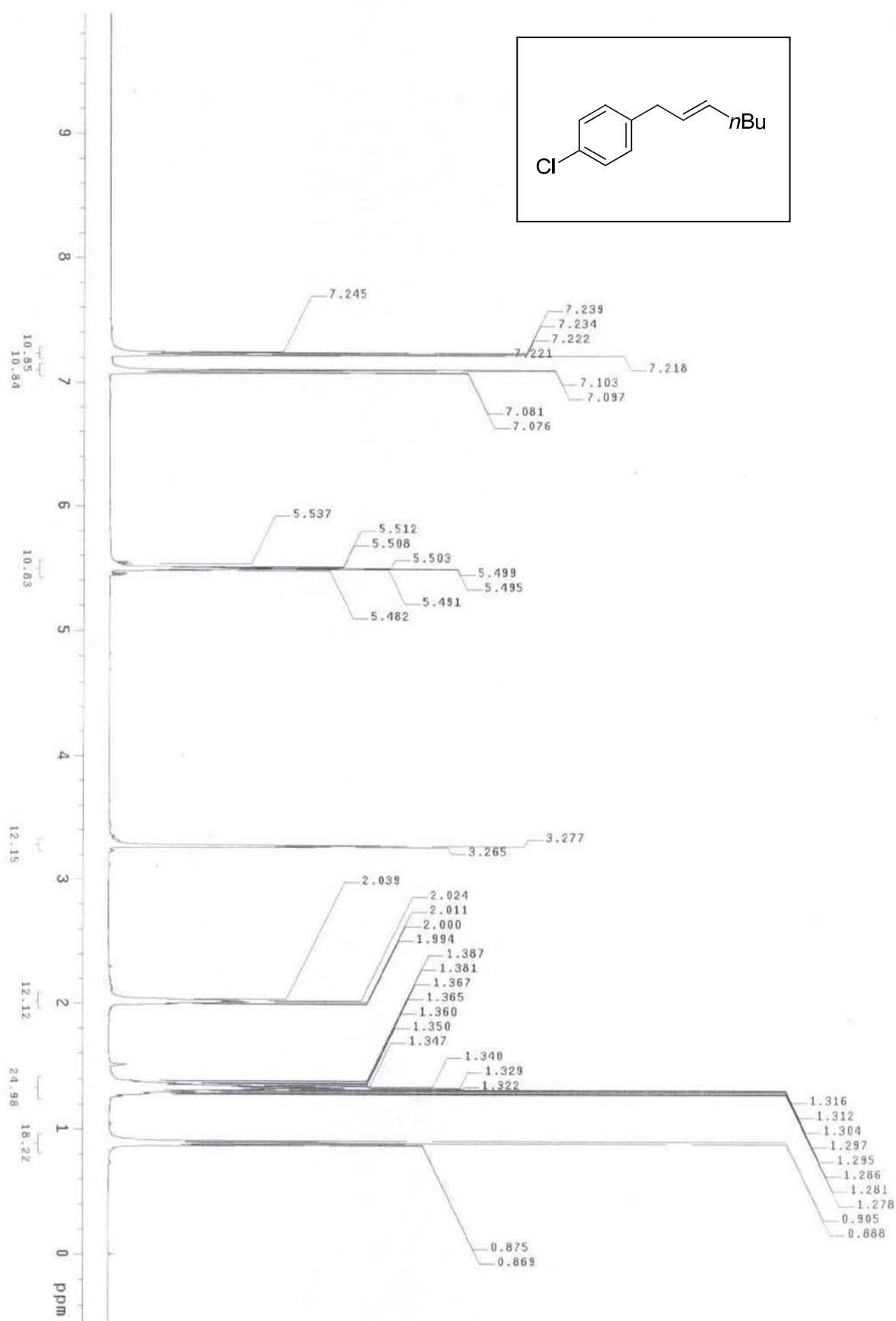

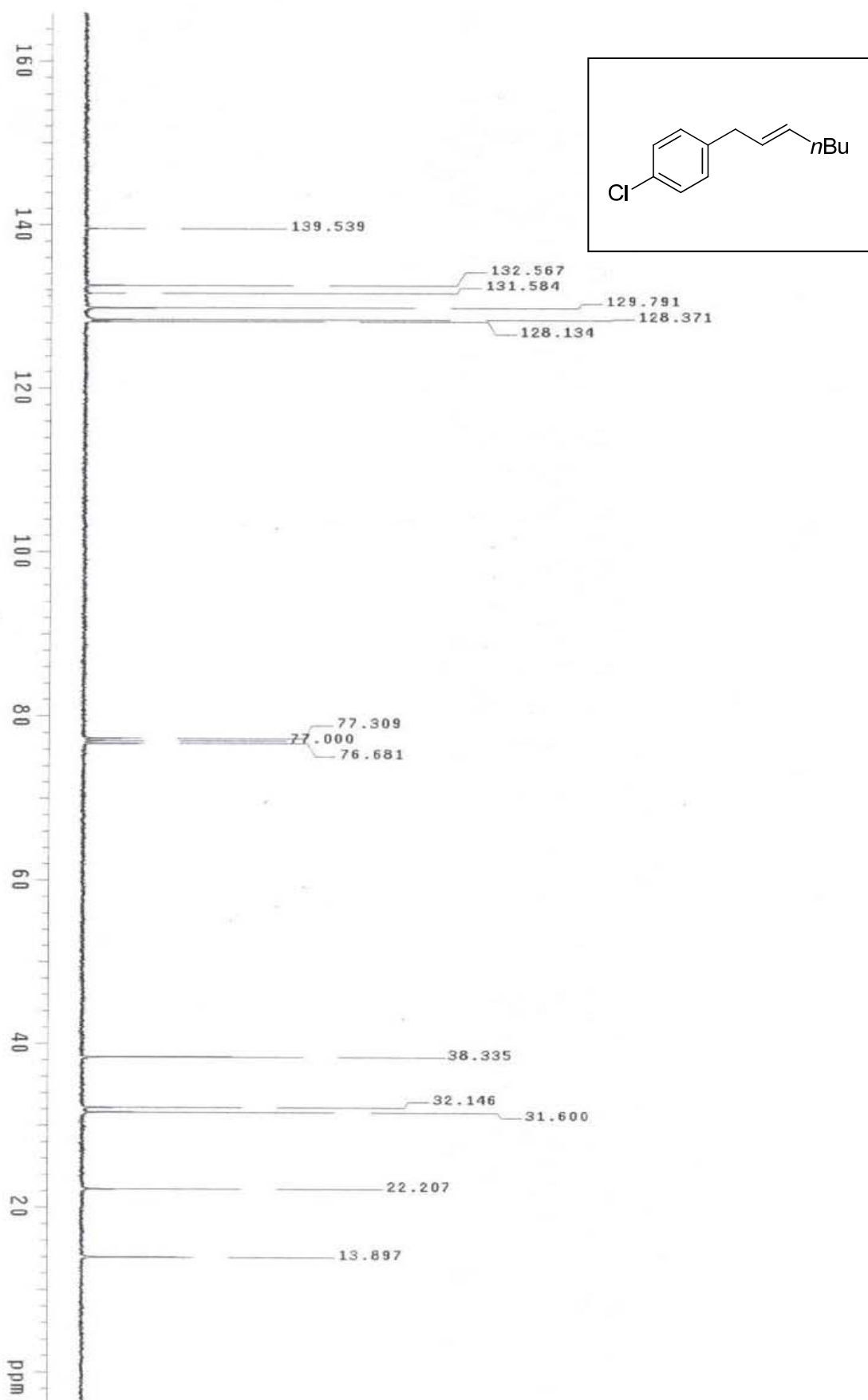

13. (*E*)-1-(hept-2-enyl)-3,5-bis(trifluoromethyl)benzene (2m)

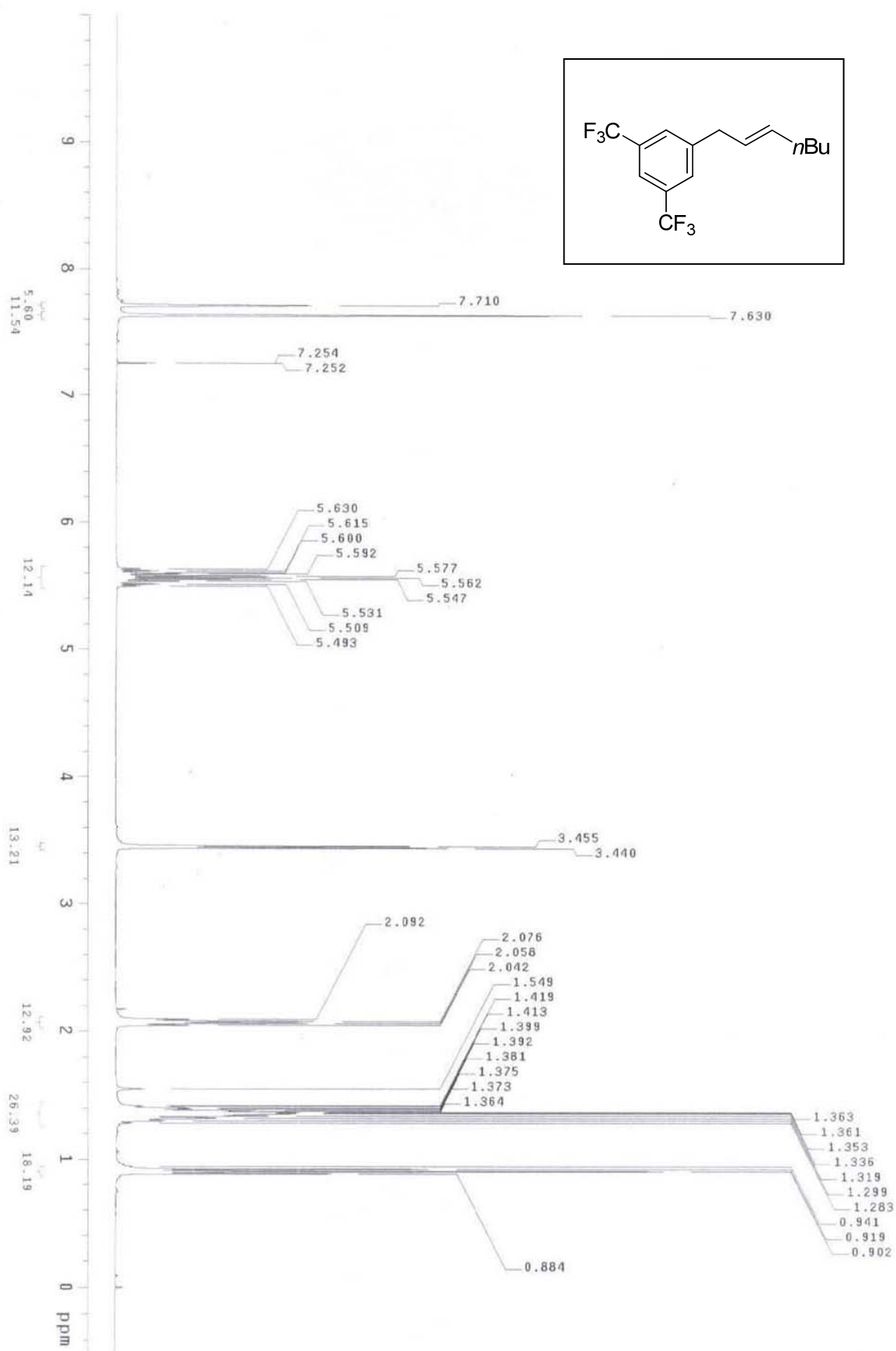

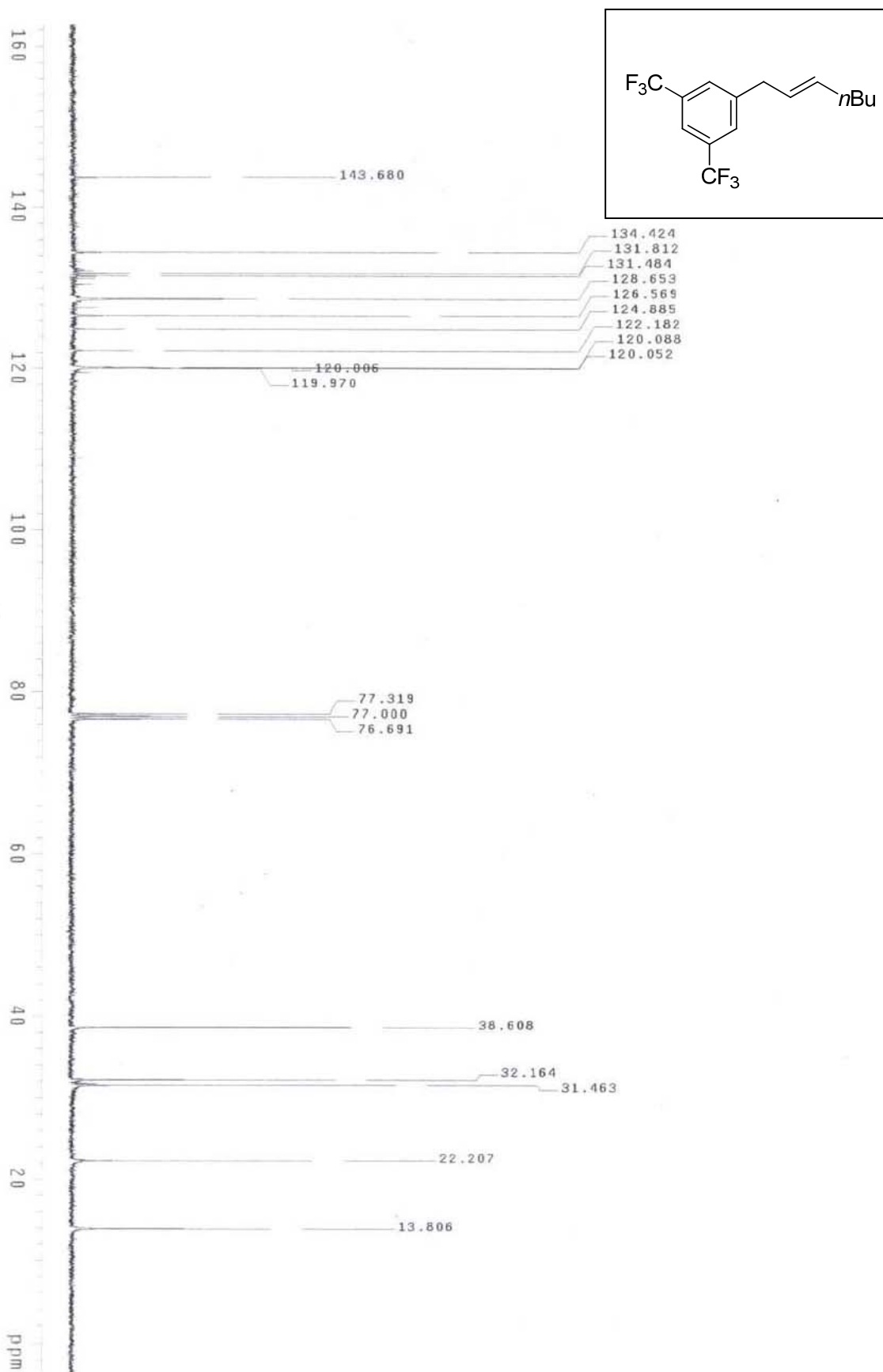

14. (*E*)-methyl 4-(hept-2-enyl)benzoate (2n)

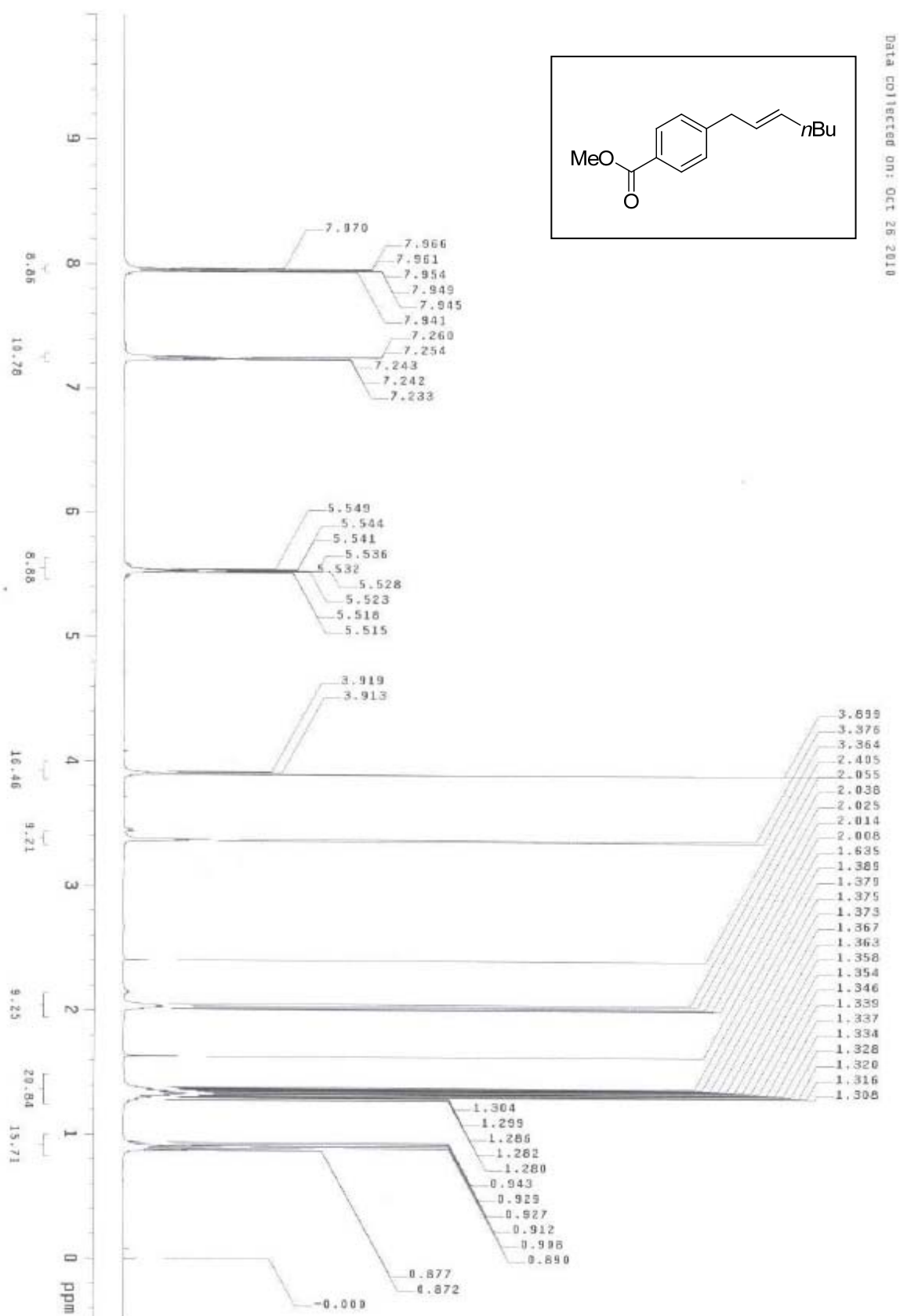

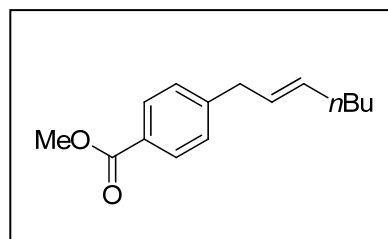

15. (*E*)-1,4-diphenylbut-2-ene (2o)

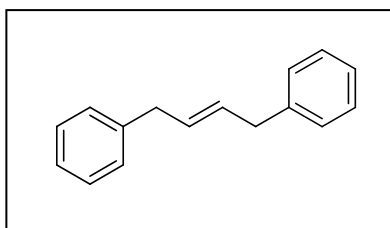
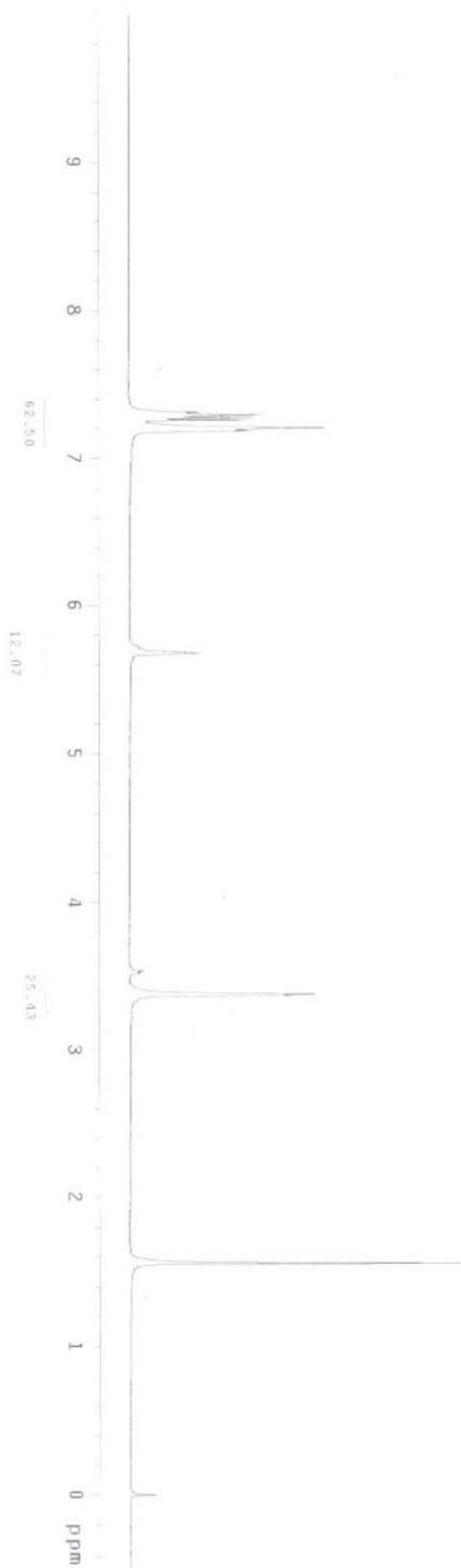

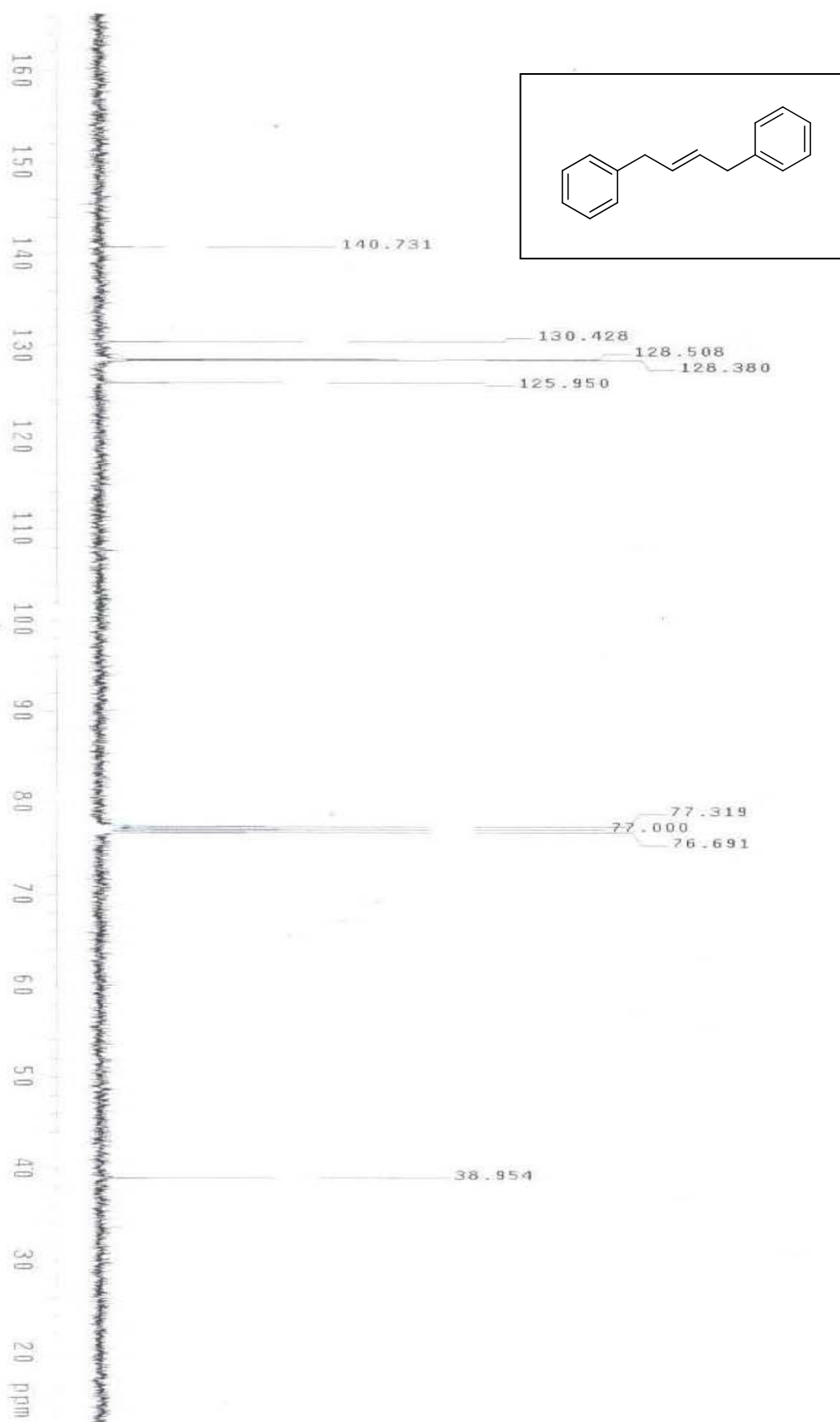

16. (E)-(3-cyclohexylallyl)benzene (2p)

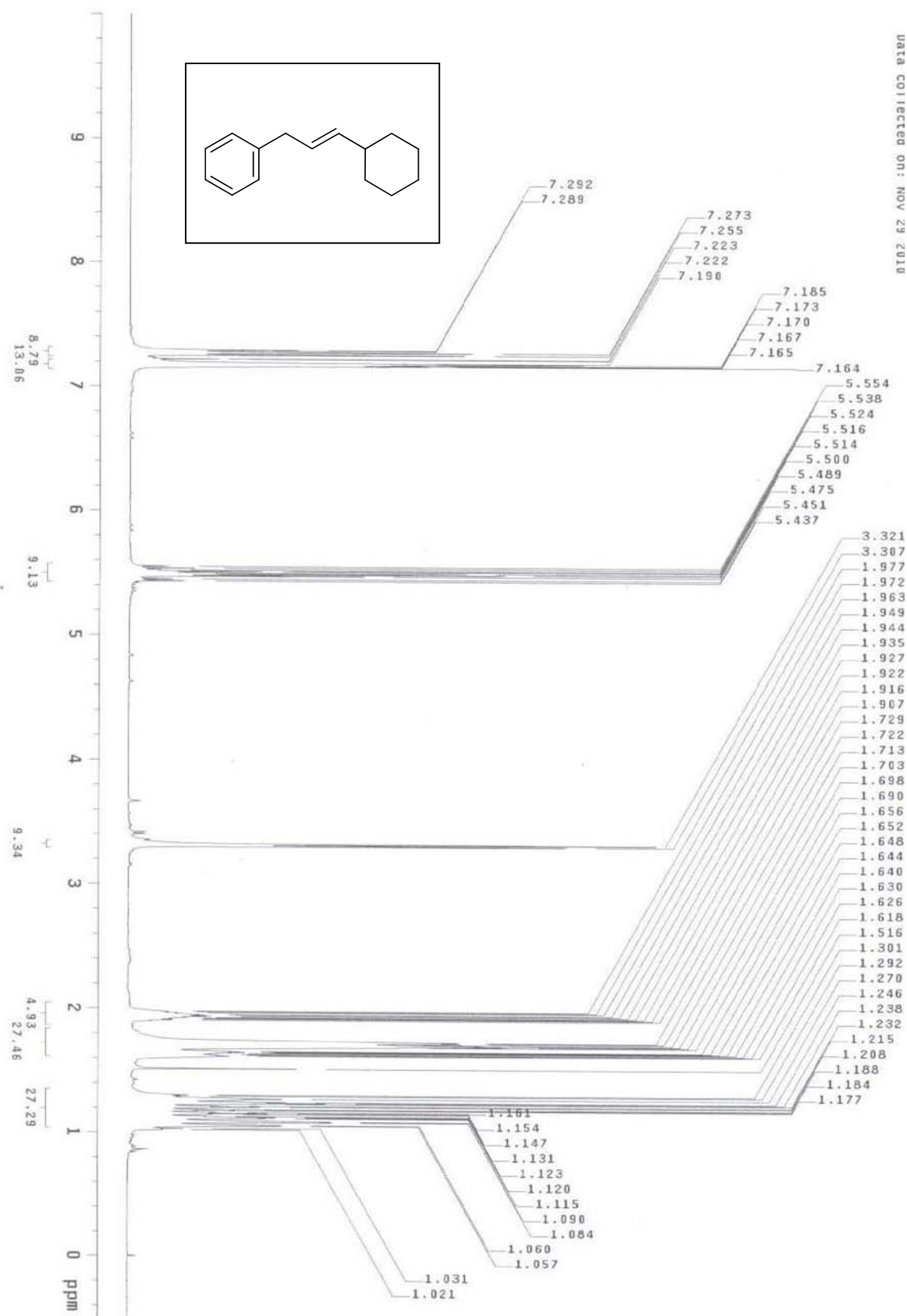

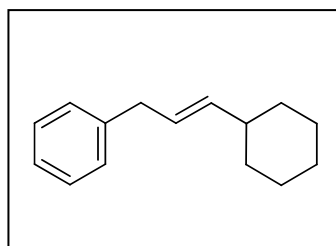
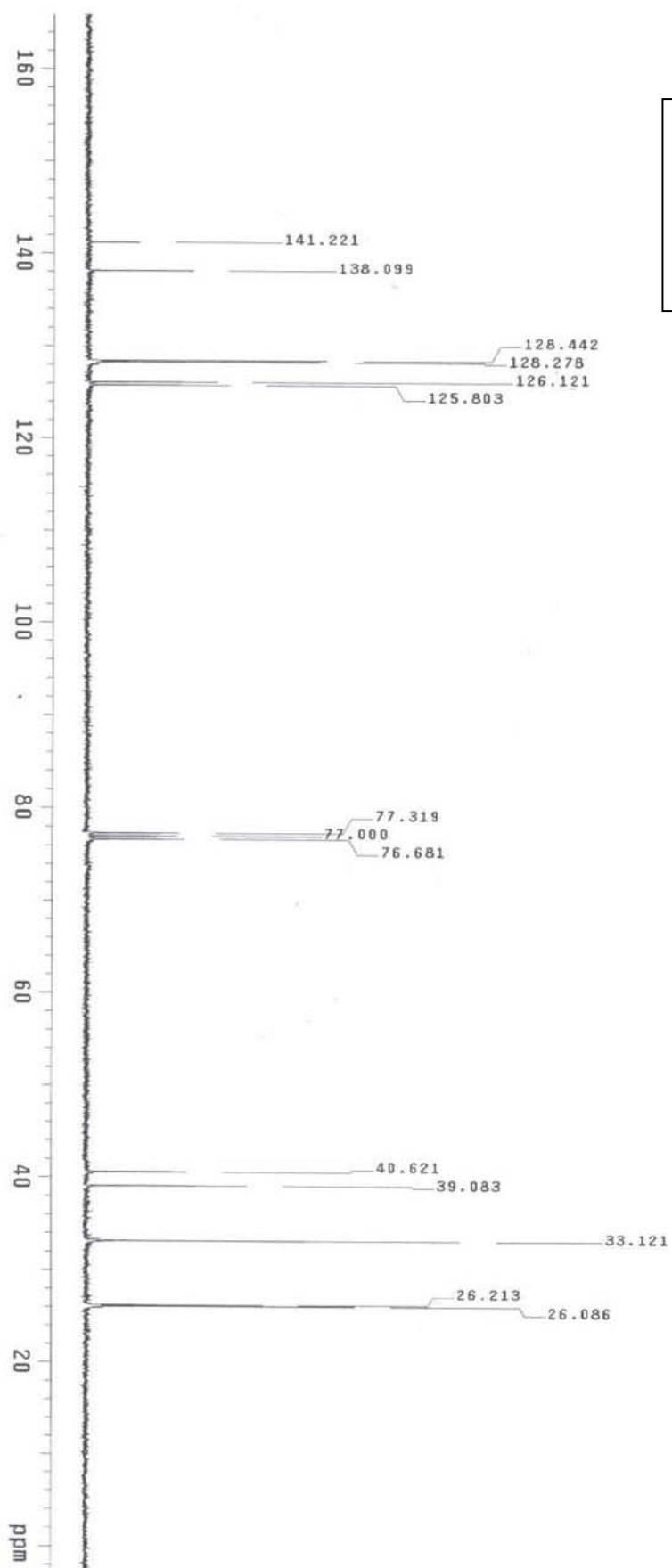

17. (E)-3-(3-phenylprop-1-enyl)thiophene (2q)

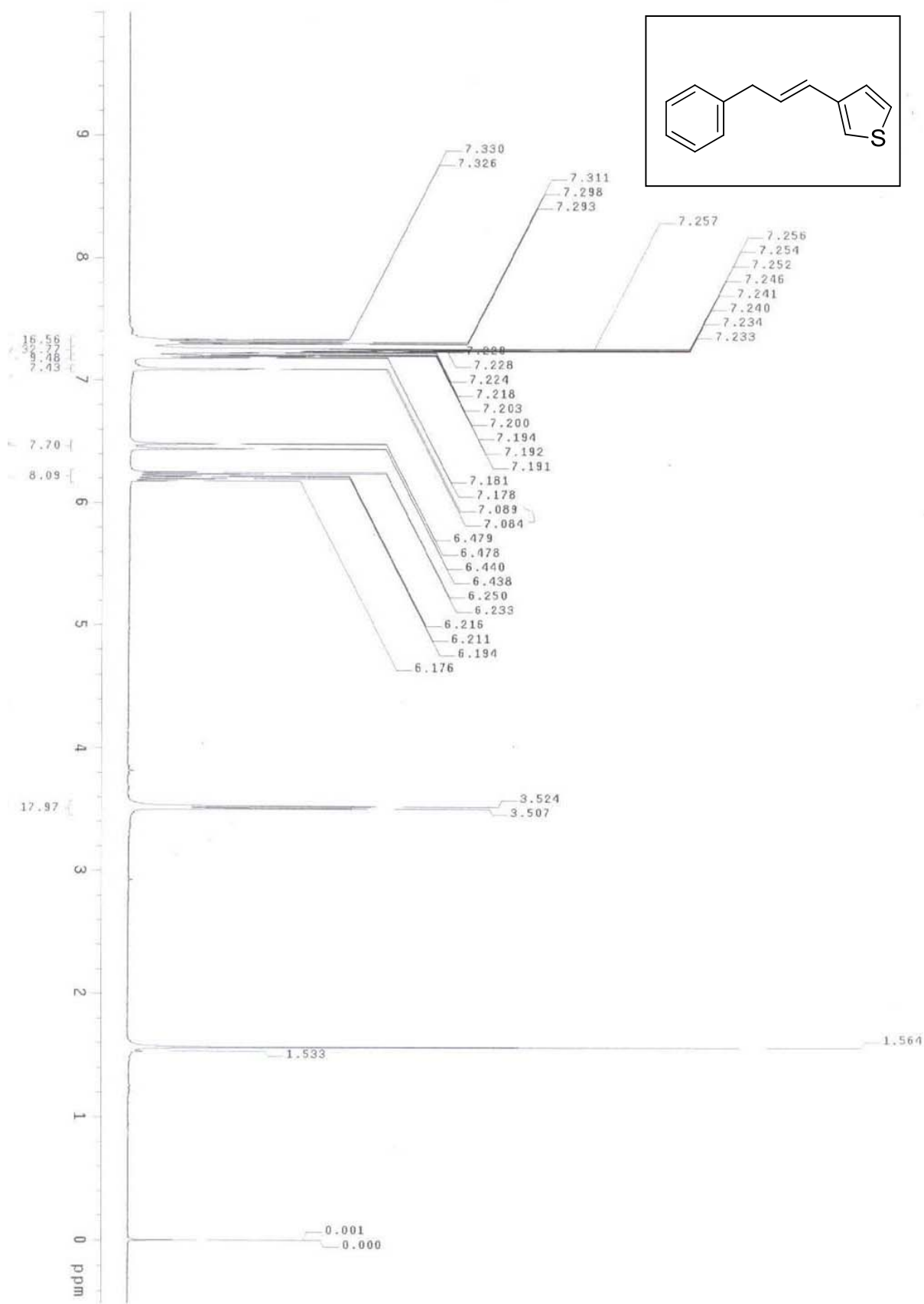

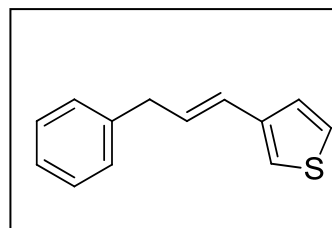
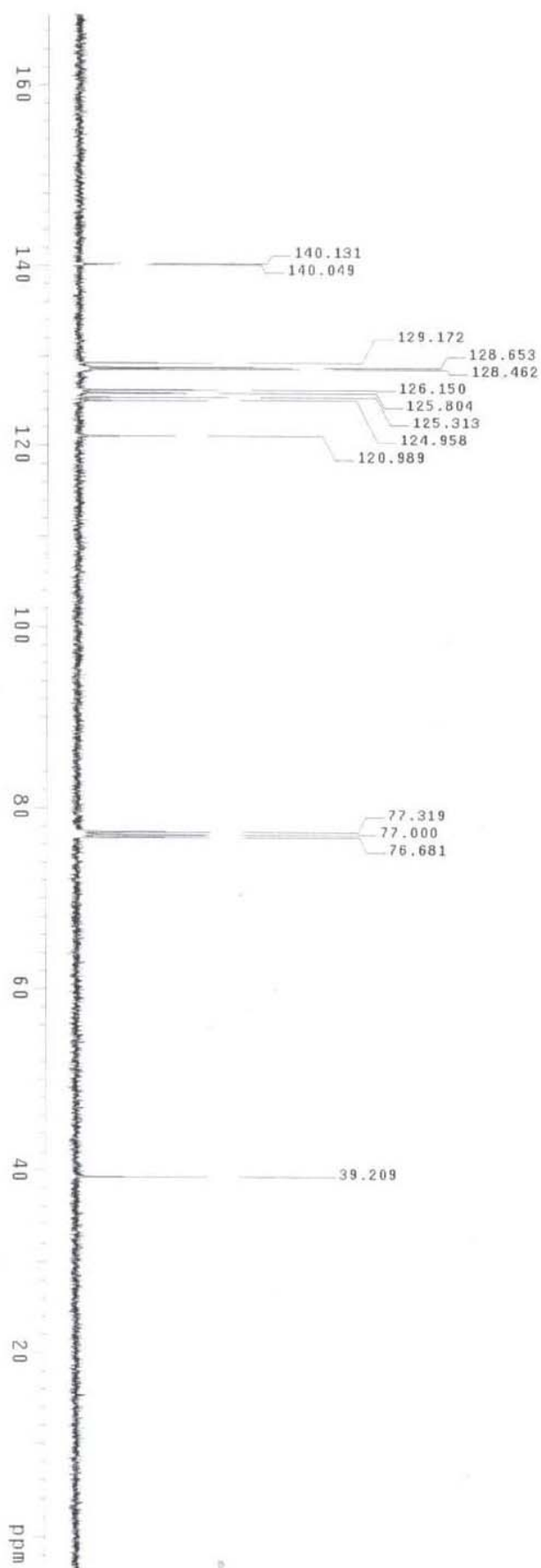

18. (*E*)-1-fluoro-4-(hept-2-enyl)benzene (2r)

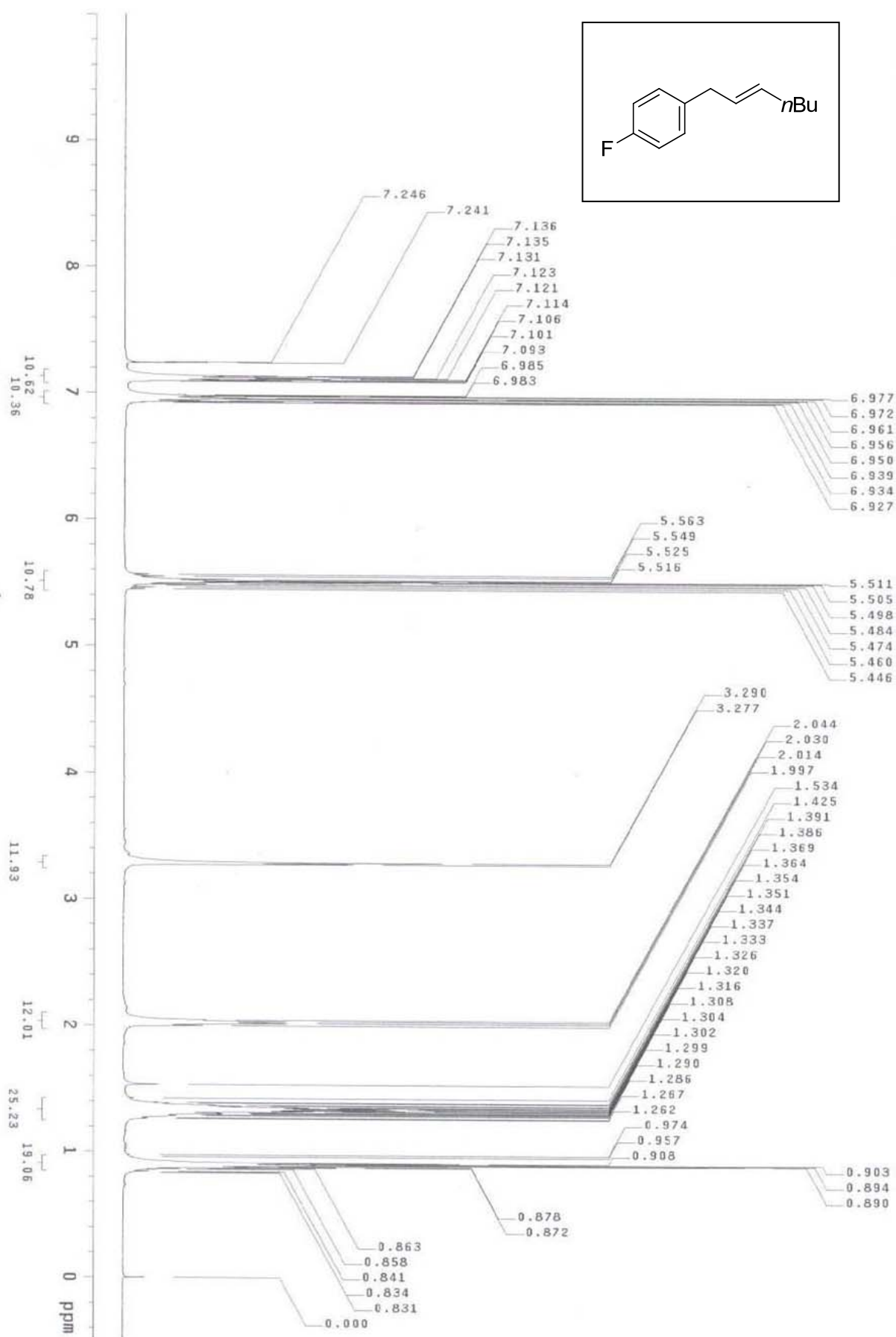

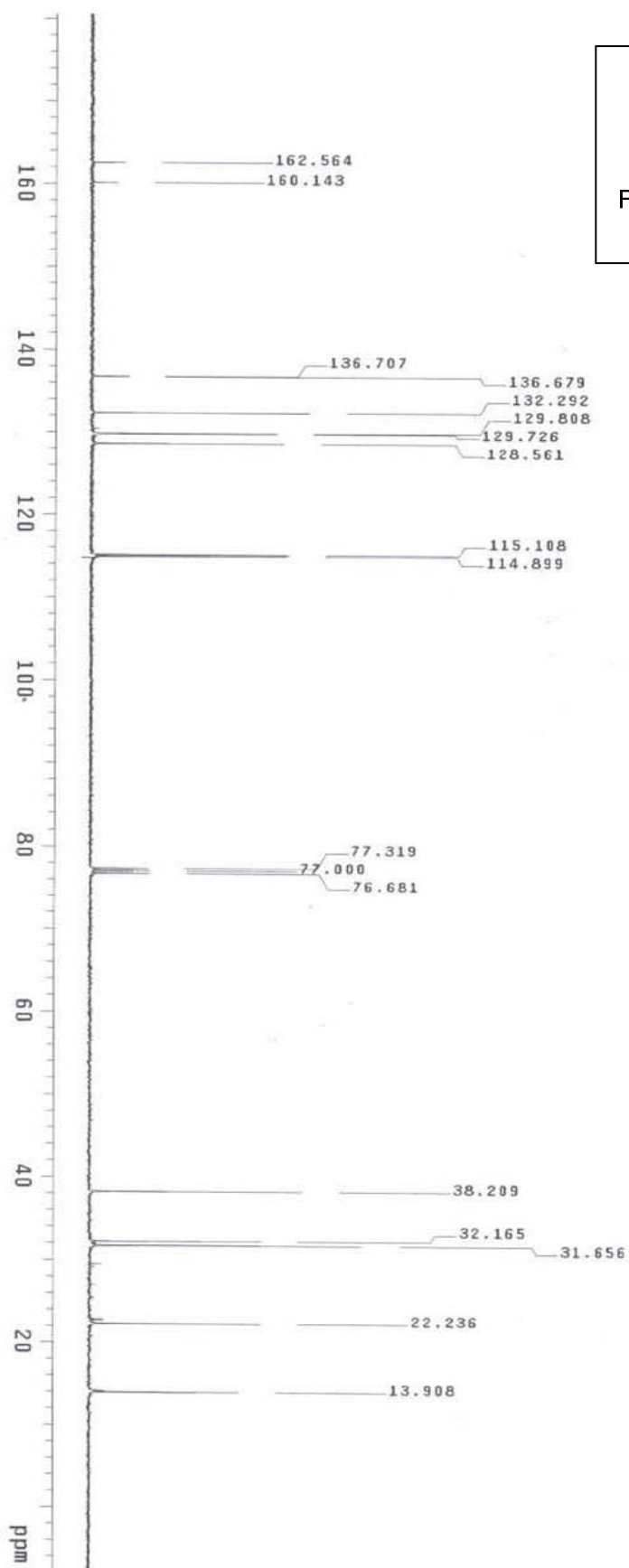

19. (E)-1-(hept-2-enyl)-4-vinylbenzene (2s)

